

# R19IT3S-MLA3FP

## 19" Intel® Core™ i5-1135G7 Defence Console Rack Panel PC



### KEY FEATURES

- Intel® Core™ i5-1135G7 2.4 GHz (turbo to 4.2GHz) Processor
- Anti-Corrosion Housing / Fanless
- Projective Touch
- Compliant with MIL-STD-810G/F , MIL-STD-461E/F
- Flush Rack / Rack Mount Mechanical Design (8U)
- Convenient On-Screen Display Controls
- AC 110~240 V Power input default
- Isolation DC 9~36 V Power input (Optional)
- Built-in Light Sensor for auto brightness control



### SPECIFICATIONS

Display			
<b>Resolution</b>	1280x1024	<b>Size</b>	19 inches
<b>Contrast Ratio</b>	1000:1	<b>Panel Brightness</b>	350 nits
<b>View Angles</b>	85,85,80,80	<b>Active Area</b>	376.32x301.06 mm
<b>Touch / Glass</b>	Projected Capacitive Multi Touch Screen PCAP with With ITO Flim (Optional)		
System Specification			
<b>Processor</b>	Intel Core i5-1135G7 2.4GHz (up to 4.2GHz) Intel Core i5-1145G7 2.6GHz (up to 4.4GHz) (Optional)	<b>Memory</b>	1 x SO-DIMM, DDR4 3200 MHz, 4GB 8GB (Optional) 16GB (Optional) 32GB (Optional)
<b>Storage</b>	1 x M.2 M-Key 2242 SATA SSD or 1 x M.2 M-Key 2280 NVMe SSD 128GB 256GB (Optional) 512GB (Optional) 1TB(for NVMe) (Optional) 2TB(for NVMe) (Optional) 4TB(for NVMe) (Optional) 1 x SATA III , up to 2TB (Optional)	<b>Ethernet controller</b>	2 x Intel® Ethernet Controller
<b>Security</b>	TPM 2.0	<b>Operating System</b>	Windows 11 IoT Enterprise SAC (64 bit) (Optional) Windows 10 IoT Enterprise (64 bit) (Optional) Linux Ubuntu 22.04 (Optional)
Environment			
<b>Operating Humidity</b>	10% to 95% RH	<b>Operating Temperature</b>	-20°C~60°C
<b>Storage Temperature</b>	-30°C~70°C		
Compliance			
<b>MIL-STD 461E/F</b>	RE101 / RE102 CE101 / CE102 with EMI Glass / Touch(Optional) RS101 / RS 103 CS101 / CS 106 / CS 109 / CS 114 / CS 115 / CS 116	<b>MIL-STD 810F/G</b>	Vibration Method 514.5 Humidity Method 507.4 Transit Drop Method516.5
Certification			

<b>Certification</b>	CE, FCC		
<b>Accessory</b>			
<b>Accessory</b>	1 x Manual(Hardcopy) 1 x Driver CD 1 x Power Cord (MIL-DTL-38999/1)		
<b>Mechanical</b>			
<b>Dimension</b>	482.6 x 399.3 x 79.6 mm	<b>Mounting</b>	Rack Mount/ VESA Mount
<b>Enclosure</b>	Metal Housing with Aluminum Bezel	<b>Cooling System</b>	Fanless Design
<b>IO Ports</b>			
<b>USB Port</b>	2 x USB 3.2 Gen 1	<b>Serial Port</b>	1 x RS232(Default)/422/485
<b>Video</b>	1 x HDMI (Optional)	<b>LAN</b>	2 x RJ-45
<b>Power</b>			
<b>Power Rating</b>	AC 100~240V, Universal, ±10% DC 9~36V, ±10% (Optional)		
<b>Control</b>			
<b>Button</b>	8 Key OSD Control Pad: Power, Brightness DOWN, Brightness UP, Night, Day, Auto / Manual, Reset, Lock		

**DIMENSIONS** UNIT:MM

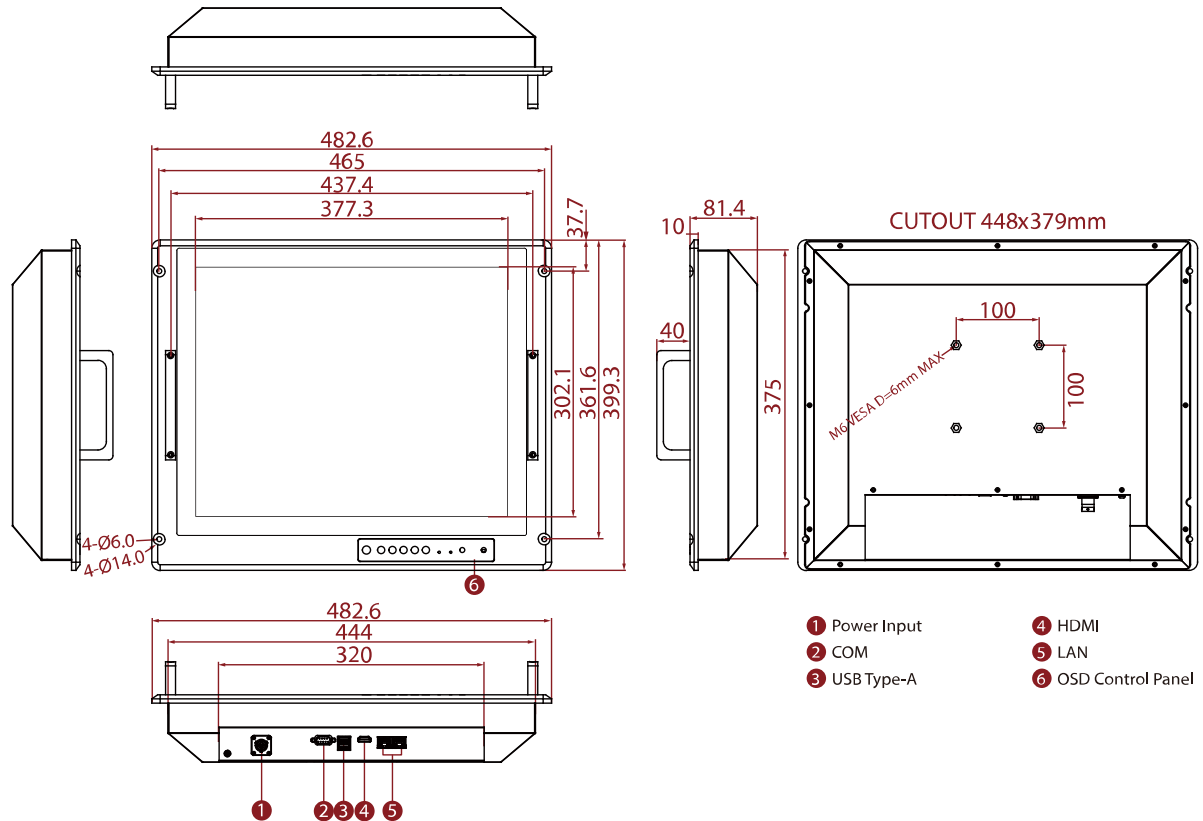

**NOTE**

1. This is a simplified drawing and some components are not marked in detail.
2. Please contact our sales representative if you need further product information.
3. All specifications are subject to change without prior notice.
4. The product shown in this datasheet is a standard model. For diagrams that contain customized or optional I/O, please contact the Winmate Sales Team for more information.

## Assured Systems

Assured Systems is a leading technology company with over 1,500 regular clients in 80 countries, deploying over 85,000 systems to a diverse customer base in 12 years of business. We offer high-quality and innovative rugged computing, display, networking and data collection solutions to the embedded, industrial, and digital-out-of-home market sectors.

### US

[sales@assured-systems.com](mailto:sales@assured-systems.com)

Sales: +1 347 719 4508  
Support: +1 347 719 4508

1309 Coffeen Ave  
Ste 1200  
Sheridan  
WY 82801  
USA

### EMEA

[sales@assured-systems.com](mailto:sales@assured-systems.com)

Sales: +44 (0)1785 879 050  
Support: +44 (0)1785 879 050

Unit A5 Douglas Park  
Stone Business Park  
Stone  
ST15 0YJ  
United Kingdom

VAT Number: 120 9546 28  
Business Registration Number: 07699660