

R15IB3S-65EX, 15-inch HazLoc Stainless Panel PC

A Panel PC that Works in Hazardous Locations and Withstands Harsh Environments

R15IB3S-65EX is a panel mount stainless panel PC with a set of features designed to withstand industrial use in hazardous locations and extreme temperatures while providing high tech solutions that increase productivity, improve safety, and reduce operational costs. The processing power comes from Intel's Celeron N2930 processor paired with genuine Intel graphics for high performance. The panel PC features a flat panel with Projected Capacitive Touch Screen and offers 1024 x 768 pixel resolution. Certified for use in Class 1, Division 2 & ATEX Zone 2 & IECEx Zone 2 locations R15IB3S-65EX device delivers processing power in rugged housing.



Highlights

- Class 1, Division 2 & ATEX Zone 2 & IECEx Zone 2 device certified for hazardous area application
- Intel Celeron Processor N2930
- 15" 1024 x 768, 550 nits (Optional 1000 nits) LCD Panel
- Fanless, streamlined enclosure for highly efficient heat dissipation
- Projected Capacitive Touch Screen
- Stainless housing
- Rated for wide temperature use -20°C to 50°C

Order Information

R15IB3S-65EX	Basic
--------------	-------

R15IB3S-65EX, 15-inch HazLoc Stainless Panel PC

A Panel PC that Works in Hazardous Locations and Withstands Harsh Environments

Display Specification

Size	15-inch LCD display
Resolution	1024 x 768
Brightness	550 nit, Optional 1000 nit
Touch	Projected Capacitive Touch Screen
Contrast Ratio	700:1
Viewing Angle	80/80/70/70
Technology	Intel® HD graphics (built-in CPU) video controller

System Specification

Processor	Intel® Celeron® Processor N2930 2M Cache, 1.83 GHz
BIOS	AMI BIOS
System Chipset	Intel®SOC
System Memory	4GB DDR3L SO-DIMM 1333 MHz ¹ (Up to 8GB)
Storage	64GB mSATA SSD Optional 32GB, 128GB, 256GB and 512GB
Operating System	Windows 7 Pro for Embedded System 64bit Windows Embedded Standard 7 64bit Windows Embedded 8.1 Industry PRO 64 bit Windows 10 IOT Enterprise 64 bit

Interface

Serial Interface	1 x M12 Type RS232/RS422/RS485(Default RS232)
LAN	1 x M12 Type RJ45 LAN
USB	1 x M21 Type USB Type-A Receptacle
Power Input	1 x M21 Type DC power input connector

Keyboard and Input

Touch	Projected Capacitive Touch Screen
Button	Power, Reset
LEDIndicators	Power, Storage

Mechanical and Environment

Dimension (W x L x H)	396 x 310 x 49 mm (15.59 x 12.20 x 1.93 inches) ²
Gross Weight	11 kg (24.25 lbs) ²
Net Weight	11.5 kg (25.35 lbs) ²
Mounting VESA	100 x 100
Cooling System	Fanless
Operating Temperature	-20° to 50°C (-4° to 122° F)
Humidity	10% to 95% RH, non-condensing
Ex protection	IECEX Zone 2 Certification (applied for) nA IIC T4 Gc -20 °C ≤ Ta ≤ +50 °C ATEX Zone 2 Certification (applied for) II 3 G Ex nA IIC T4 Gc -20 °C ≤ Ta ≤ +50 °C UL Listing Certification (applied for) Class I, Division 2, Groups A, B, C, and D MIL-STD-810F/G Method 516.6
Shock	MIL-STD-810F/G Method 516.6
Drop	MIL-STD-810F/G Method 516.6
Vibration	MIL-STD-810F/G Method 514.6
IP	Proof IP65 certified, dustproof and waterproof
EMC	CE, FCC

Power Management

Power Input	9-36V DC with isolation protection
Power Consumption	56W (typ.) ³
Adapter	12V / 84W AC to DC Adapter

Accessories

Standard Accessories

Power Cord	Varies by product destination
Power Cable (rated IP65)	
Power Adapter to IP65 Connector	90PO12080003
RS232 Male Cable (M12 rated IP65)	94G0123090Q0
2 x USB2.0 Female Cable (rated IP65)	9480108080Q0
RJ45 Cable (M12 rated IP65)	94I0120080K0
Ethernet Extension Adapter	60L0A8400000
USB Adapter (USB type A to type B)	60A028010000
VESA Mounting Screws	913511101101
User Manual	915215011003

Drawing ⁴

w/o Box Cover

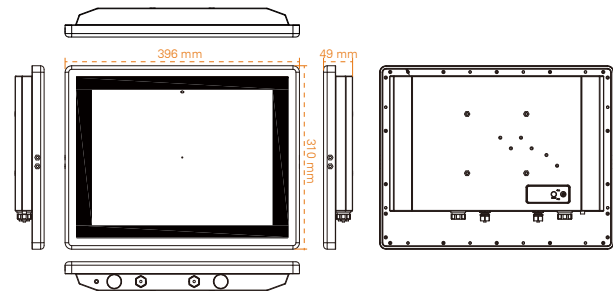

With Box Cover

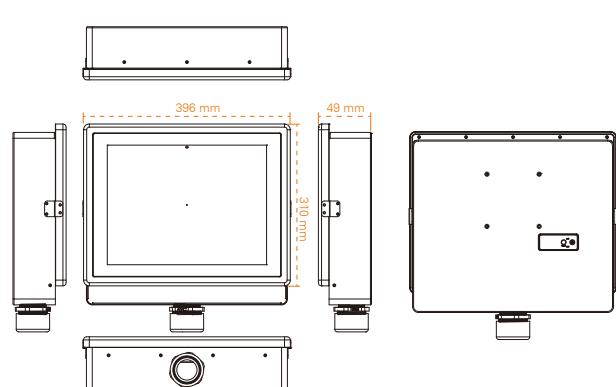

Do Not Expose the Battery Pack to Excessive Heat, or Extreme Heat (Near Fire, in Direct Sunlight for example)
Do not expose bare skin to this product when handling this unit in extreme hot or cold environments

- Total usable memory will be less depending upon actual system configuration
- Length measurements do not include protrusions. Weight varies with options.
- Measured at maximum backlight and high CPU load.
- Accessories and Integrated Options may vary depending on your configuration.

R15IB3S-65EX, 15-inch HazLoc Stainless Panel PC

A Panel PC that Works in Hazardous Locations and Withstands Harsh Environments

Accessories Cable Pin Assignment

USB cable

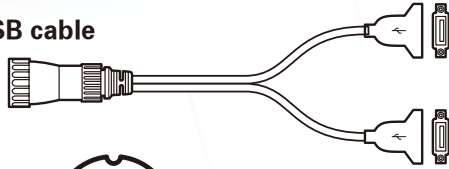

Pin No.	Symbols	Color
CN1-1	VCC	RED
CN1-2	VCC	RED
CN1-3	D-	WHITE
CN1-4	D-	WHITE
CN1-5	D+	GREEN
CN1-6	D+	GREEN
CN1-7	GND	BLACK
CN1-8	GND	BLACK
CN1-9	Braid	

Ethernet (LAN) cable



Pin No.	Color
CN2-1	White/Orange
CN2-2	Orange
CN2-3	White/Green
CN2-4	Blue
CN2-5	White/Blue
CN2-6	Green
CN2-7	White/Brown
CN2-8	Brown

Power adapter



Pin No.	Symbols	Color
CN2-1	VCC	Follow Adapter
CN2-2	GND	Follow Adapter
CN2-3	GND	Follow Adapter

RS-232 cable



Pin No.	Symbols	Color
CN2-1	DCD-CON2	Green
CN2-2	DSR-CON2	Brown
CN2-3	RXD-CON2	Red
CN2-4	RTS-CON2	Orange
CN2-5	TXD-CON2	Blue
CN2-6	CTS-CON2	White
CN2-7	DTR-CON2	Purple
CN2-8	RI-CON2	Yellow
CN2-9	GND-CON2	Black

DC power cable open wire

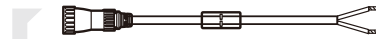

Pin No.	Symbols	Color
CN2-1	VCC	Red
CN2-2	Shield	
CN2-3	GND	Black



Ensure that the external power source is OFF before connecting or disconnecting the DC in jack.

Mounting Instruction

Customer's Cutout

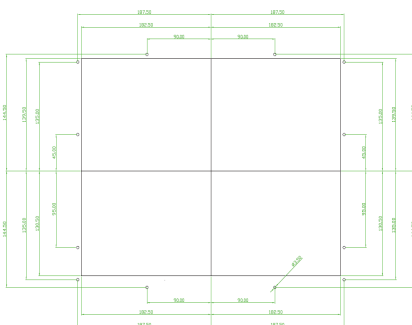

Mounting to the Enclosure

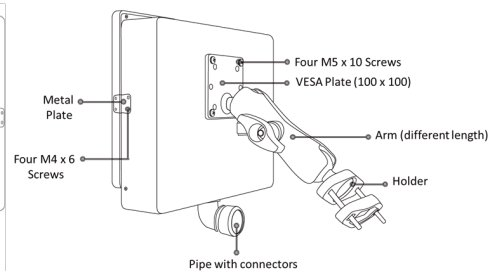
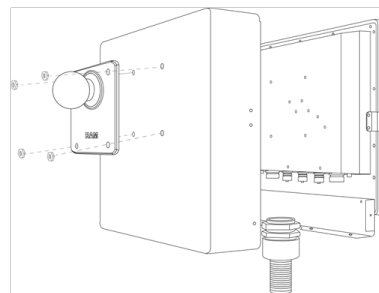

Assured Systems

Assured Systems is a leading technology company with over 1,500 regular clients in 80 countries, deploying over 85,000 systems to a diverse customer base in 12 years of business. We offer high-quality and innovative rugged computing, display, networking and data collection solutions to the embedded, industrial, and digital-out-of-home market sectors.

US

sales@assured-systems.com

Sales: +1 347 719 4508
Support: +1 347 719 4508

1309 Coffeen Ave
Ste 1200
Sheridan
WY 82801
USA

EMEA

sales@assured-systems.com

Sales: +44 (0)1785 879 050
Support: +44 (0)1785 879 050

Unit A5 Douglas Park
Stone Business Park
Stone
ST15 0YJ
United Kingdom

VAT Number: 120 9546 28
Business Registration Number: 07699660