

U.K. ☎ +44 1785 879050 U.S. ☎ +1 347 7194508 www.assured-signage.com

Sureview 43" High Vibrance Android Advertising Display



Perfect for brightly-lit retail environments or as a budget friendly window display

700cd/m² Brightness

Designed for brightly lit spaces such as retail stores and shopping centres. More than twice the brightness level of a standard domestic screen or monitor to make your content really stand out from the crowd.



700cd/m²

Ultra Resistant to Blackening Defect (up to 110°C)

LCD panels exposed to direct sunlight suffer from temporary blackening defect. These displays use a special panel that can withstand surface temperatures up to 110°C with no blackening defect occurring.

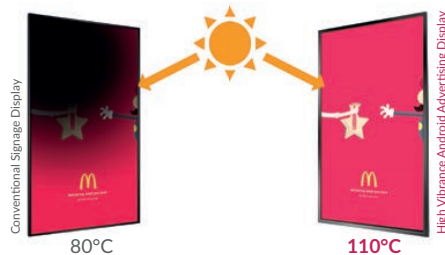

Plug and Play

Plug and Play is the most straightforward way to upload content to the screen. Simply load images and videos on a USB stick, insert in the display, wait for your content to copy over and then remove. Your images and videos will now play in a continuous loop.



Narrow Bezel

These displays feature a slim border for applications where this is important, such as placing multiple screens side-by-side.



Other Features

IPS Panel

Commercial grade IPS technology accurately displays image quality and colour depth with no fall-off in colour accuracy. These panels are designed to achieve ultimate lifelike colour temperature when used in either landscape or portrait.



Slim and Lightweight Design

Using open cell panel manufacturing processes ensure the enclosure of these displays is super slim and lightweight. Making installation a breeze and improving space efficiency.



24/7 Commercial Use

These displays use a commercial grade LCD panel and LED backlight. They have the ability to be in constant use 24/7 for over 70,000 hours and have no external buttons or controls to avoid tampering.



Multiple Inputs

Should you need to use the screen as a monitor you can connect it to an external source, like a PC or media player, using the HDMI input or the VGA and 3.5mm audio jack inputs.

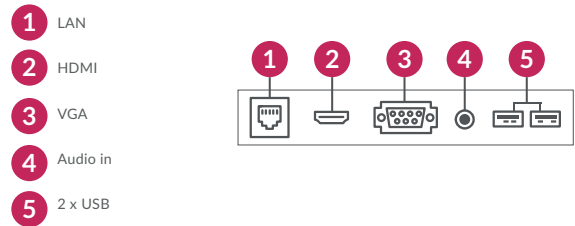

Free Scheduling Software

These displays come with free optional scheduling software for displaying different content at different times of the day. You can also display a "ticker tape" style scrolling text message along the bottom of the screen.

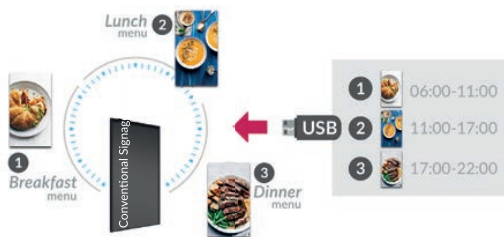

Scrolling Text

You can display a "ticker tape" style scrolling text message along the bottom of the screen, to help you get your message across or help highlight any specific promotions or offers.



Wide Viewing Angle

Thanks to the IPS technology these displays provide fantastic image quality with a remarkable viewing angle of 178° in both landscape and portrait.



Optional Network Upgrade

For a small charge you can upgrade your screen to be networked, allowing you to connect your screen via Wi-Fi, LAN or 4G, then remotely update it over the internet. For more information please go to page 115.



Key Features



700CD/M² BRIGHTNESS



PLUG AND PLAY



INTEGRATED ANDROID
MEDIA PLAYER



24/7 COMMERCIAL GRADE



LANDSCAPE OR PORTRAIT
ORIENTATION



CONNECT DEVICES

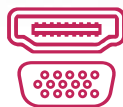

IPS PANEL

IPS

OPTIONAL NETWORK UPGRADE

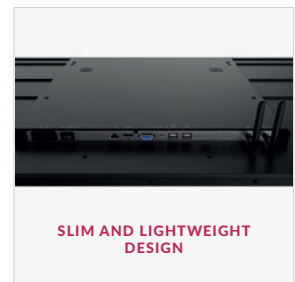
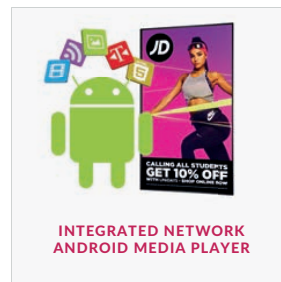
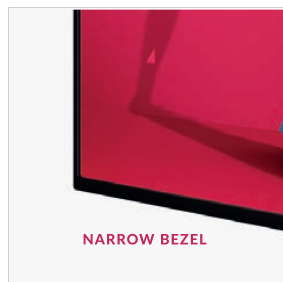
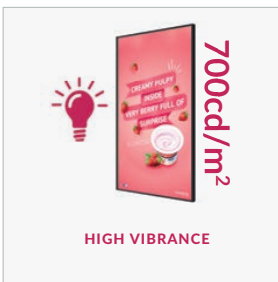

Specification Table

		43 Inch
Panel	Resolution	1920x1080
	Display Area (mm)	941.2x529.4
	Bezel Size (mm)	Top/Left/Right: 11.2 Bottom: 17.3
	Aspect Ratio	16:9
	Brightness (cd/m ²)	700
	Colour	16.7M
	Viewing Angle	178°
	Contrast Ratio	4000:1
Audio	Speaker Type	5W, 8Ω (x2)
AV Inputs	Video	HDMI, VGA
	Audio	Audio Socket (3.5mm)
Power	Power Consumption (W)	45
	Input Voltage	AC110~240V (50Hz~60Hz)
Mechanical	Unit Size (WxHxD mm)	963.6x557.9x48.1
	Package Size (WxHxD mm)	1067x660x163
	VESA Holes (mm)	400x200
	Net Weight (kg)	11.7
	Gross Weight (kg)	15.4
Environmental	Surface Panel Temperature	Up to 110°C (230°F)
	Operating Temperature	0°C to 50°C
	Storage Temperature	-30°C to 60°C
	Operating Humidity	10% to 80%
	Storage Humidity	5% to 95%
Computer	Media Formats	Video (MPG, AVI, MP4, RM, RMVB, TS), Audio (MP3, WMA), Image (JPG, GIF, BMP, PNG)
	Media Resolution	1920x1080/1080x1920
	CPU	Quad-Core ARM Cortex A17, 1.6GHz
	GPU	Quad-Core ARM Mali-T764
	RAM	DDR3 2GB
	ROM	8GB eMMC
	USB	1 x USB (OTG/HOST), 1 x USB (HOST)
	LAN	10/100M Ethernet (Network Version Only)
	Wi-Fi	802.11b/g/n/ac (Network Version Only)
	Bluetooth	Bluetooth 4.0
	OS	Android 7.1
	Graphic Engine	OpenGL ES 1.1/2.0/3.0/3.1, OpenCL 1.1, Renderscript, Direct3D 11.1
	Accessories	Included
Optional		Wall Mount, Floor Stand/Trolley, Ceiling Mount, Table Stand
Warranty	Warranty Period	3 Year Warranty
	Technical Support	Lifetime

Errors and omissions excepted



SUREVIEW

Technical Drawing

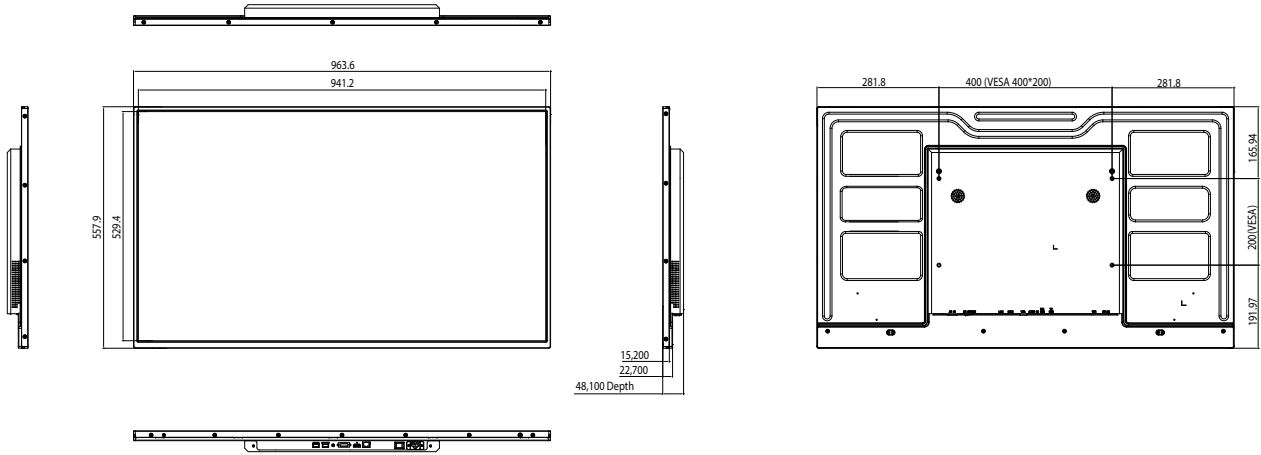

Why Choose Our Commercial Display Solutions?



Lifetime Technical Support

From the moment you receive your product, throughout the duration of your warranty and even after your warranty has expired we are here to support you. If you require any assistance setting up or using your product, or have any problems at all, we can provide free technical support via telephone and email.



On-site Support and Maintenance*

If needed, we can provide an installation service for any of our products. We can also set up service-level agreements for larger projects that require maintenance contracts.



Extended Warranty*

All of our commercial display products come with a 3 year commercial warranty as standard but if you want to extend this you can upgrade this to cover a 5 year period at point of purchase.



Training

As well as providing free remote CMS training sessions and webinars we can also visit you to deliver bespoke training for our software and hardware*.



Advanced Replacements†

Should your display suffer from any kind of hardware failure during the warranty period we will send you an advanced replacement and arrange for your old display to be collected, free of charge. This ensures no downtime where you are without a screen.



Custom Product Testing & Configuration

If you need us to test third party software or a website, or configure your screen in a particular way before it is dispatched (e.g. in a particular orientation or network mode), we can do so to make your life easier.



3D Rendering

Want to know how a particular screen will look once installed? Send us a photo of the location and we will create a 3D rendering of any screen in situ to help you to visualise how amazing it will look.



Logistics Support

We hold more stock in our UK warehouse than any other manufacturer so we can help you meet tight deadlines. For last minute orders we can also offer special express or morning delivery options*. We also carry out UK based quality control checks on every display before it leaves our warehouse.



Project Support

If you need to loan a sample unit to test we'd be more than happy to arrange this. We can also provide a rental service for temporary projects*.



Customisation*

Your display can be customised to suit your requirements by adding your logo or printed graphics or even tailoring the colour of a display. We can also carry out hardware modifications to existing products or manufacture bespoke solutions for special projects.



Extras*

As well as being able to provide accessories and add-ons, such as extra remote controls, NUC PCs and video wall controllers, we can also supply custom made flight cases which are great if a display needs to be moved safely from place to place.

Assured Systems

Assured Systems is a leading technology company with over 1,500 regular clients in 80 countries, deploying over 85,000 systems to a diverse customer base in 12 years of business. We offer high-quality and innovative rugged computing, display, networking and data collection solutions to the embedded, industrial, and digital-out-of-home market sectors.

US

sales@assured-systems.com

Sales: +1 347 719 4508
Support: +1 347 719 4508

1309 Coffeen Ave
Ste 1200
Sheridan
WY 82801
USA

EMEA

sales@assured-systems.com

Sales: +44 (0)1785 879 050
Support: +44 (0)1785 879 050

Unit A5 Douglas Park
Stone Business Park
Stone
ST15 0YJ
United Kingdom

VAT Number: 120 9546 28
Business Registration Number: 07699660