

SFP-10G-WA40-H3

10G Fiber SFP+ Transceiver WDM-A, Single Mode 40Km / LC/ Tx:1270nm Rx: 1330nm, 0°C~70°C
(HP H3C Compatible)

Features



- ▶ 11.1Gbps Data Links
- ▶ Up to 40km Transmission on SMF
- ▶ Single Mode Fiber Tx:1270 Rx:1330
- ▶ 2-Wire Interface with Integrated Digital Diagnostic Monitoring
- ▶ EEPROM with Serial ID Functionality
- ▶ Hot-Swappable SFP+ Design
- ▶ Compliant with SFP+ Multi-Source Agreement
- ▶ Single LC Connector
- ▶ Single +3.3V Supplied Power
- ▶ SFP-8472 Compliant
- ▶ SFP-8431 Compliant
- ▶ RoHS Compliant
- ▶ Operating Temperature Range: -0° to 70° C
- ▶ 5-Year Warranty

▶ Dimensions (unit = mm)

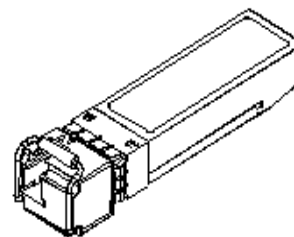
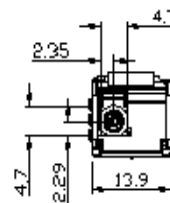
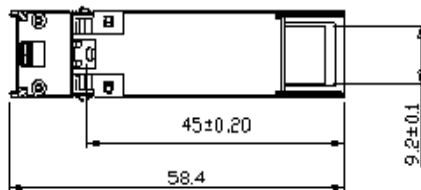
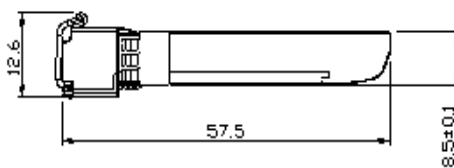
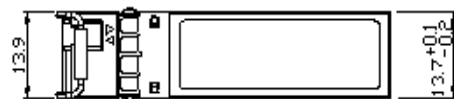

► Specifications

Technology

| | |
|---------------|--------------|
| Standards | IEEE 802.3ae |
| Transfer Rate | 10.3125Gbps |

Max Ratings

| | |
|----------------------|-------------------------|
| Storage Temperature | -40~85° C |
| Humidity | 5~95% non-condescending |
| Power Supply Voltage | 0.3 ~ 4 Volts Max |
| Signal Input Voltage | Vcc -0.3 ~ +0.3 |

Recommended Operating Conditions

| | |
|-----------------------|-------------------------------|
| Operating Temperature | 0 ~ 70°C |
| Power Supply Voltage | 3.3 Volts |
| Power Supply Current | 450mA |
| Data Rate | 10.3125 Gbps |
| Transmission Distance | 40km |
| Fiber Type | Single Mode Fiber 9/125um SMF |

Optical Characteristics Tx

| | |
|-------------------------------|--------------------------------------|
| Average Launch Power | -6 ~ -1 dBm |
| Center Wavelength Range | 1260-1270-1280nm 1320-1330-1340nm |
| Single Mode Suppression Ratio | 30dB |
| Spectrum Bandwidth (-20dB) | 1nm |
| Extinction Ratio | 3.5 |

Optical Characteristics Rx

| | |
|---------------------------|--------------------------------------|
| Center Wavelength Range | 1320-1330-1340nm 1260-1270-1280nm |
| Receiver Sensitivity | -14.4dBm |
| Saturation Power Overload | 0.5dBm |
| Assert Power | -30dBm |
| Deassert | -14dBm |
| Hysteresis | 0.5 ~ 5 dB |

Electrical Interface Characteristics Tx

| | |
|-----------------------------------|------------------|
| Power Supply Current | 450mA |
| Differential Data Input Voltage | 180 ~ 700 m Vp-p |
| Differential Line Input Impedance | 100 Ohm |
| Transmitter Fault Output High | 2.4V |
| Transmitter Fault Output Low | -0.3 ~0.8 V |

Electrical Interface Characteristics Rx

| | |
|-----------------------------------|------------------|
| Differential Data Input Voltage | 300 ~ 850 m Vp-p |
| Differential Line Input Impedance | 100 Ohm |
| Receiver LOS Pull Up Resistor | 4.7 ~ 10 KOhm |
| Data Output Rise/Fall Time | 38 |
| LOS Output Voltage-High | 2V |
| LOS Output Voltage-Low | -0.3 ~ 0.4 V |

► Pin Assignment

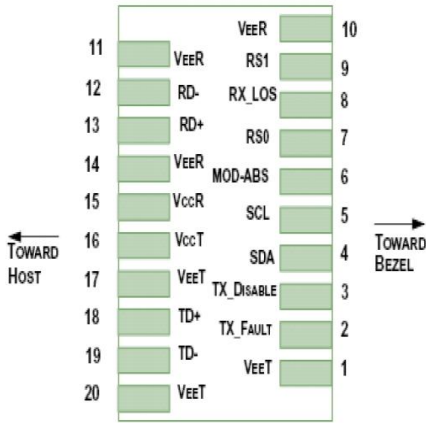

| Pin | Symbol | Name/Description | NOTE |
|-----|--------------------|--|------|
| 1 | V _{EET} | Transmitter Ground (Common with Receiver Ground) | 1 |
| 2 | T _{FAULT} | Transmitter Fault. | 2 |
| 3 | T _{DIS} | Transmitter Disable. Laser output disabled on high or open. | 3 |
| 4 | SDA | 2-wire Serial Interface Data Line | 4 |
| 5 | SCL | 2-wire Serial Interface Clock Line | 4 |
| 6 | MOD_ABS | Module Absent. Grounded within the module | 4 |
| 7 | RS0 | Rate Select 0 | 5 |
| 8 | LOS | Loss of Signal indication. Logic 0 indicates normal operation. | 6 |
| 9 | RS1 | No connection required | 1 |
| 10 | V _{EEER} | Receiver Ground (Common with Transmitter Ground) | 1 |
| 11 | V _{EEER} | Receiver Ground (Common with Transmitter Ground) | 1 |
| 12 | RD- | Receiver Inverted DATA out. AC Coupled | |
| 13 | RD+ | Receiver Non-inverted DATA out. AC Coupled | |
| 14 | V _{EEER} | Receiver Ground (Common with Transmitter Ground) | 1 |
| 15 | V _{CCR} | Receiver Power Supply | |
| 16 | V _{CCT} | Transmitter Power Supply | |
| 17 | V _{EET} | Transmitter Ground (Common with Receiver Ground) | 1 |
| 18 | TD+ | Transmitter Non-Inverted DATA in. AC Coupled. | |
| 19 | TD- | Transmitter Inverted DATA in. AC Coupled. | |
| 20 | V _{EET} | Transmitter Ground (Common with Receiver Ground) | 1 |

► Interface Circuit

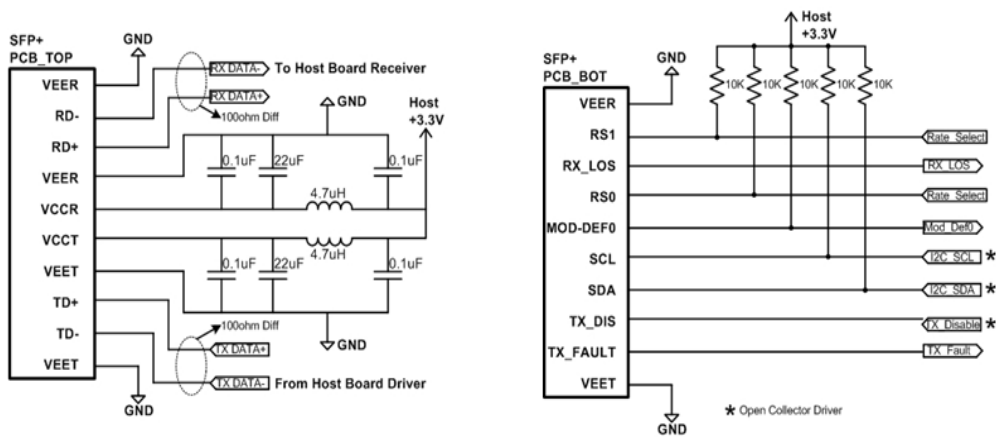

▶ **Regulatory Approvals**

| Feature | Reference | Performance |
|------------------------------------|--|---------------------------|
| Electrostatic discharge (ESD) | IEC/EN 61000-4-2 | Compatible with standards |
| Electromagnetic Interference (EMI) | FCC Part 15 Class B EN 55022 Class B (CISPR 22A) | Compatible with standards |
| Laser Eye Safety | FDA 21CFR 1040.10, 1040.11 IEC/EN 60825-1, 2 | Class 1 laser product |
| Component Recognition | IEC/EN 60950 , UL | Compatible with standards |
| ROHS | 2002/95/EC | Compatible with standards |
| EMC | EN61000-3 | Compatible with standards |

▶ **Ordering Information**

- SFP-10G-WA40-H3** 10G Fiber SFP+ Transceiver WDM-A, Single Mode 40Km / LC/ Tx:1270nm Rx: 1330nm, 0°C~70°C (HP H3C Compatible)
- SFP-10G-WB40-H3** 10G Fiber SFP+ Transceiver WDM-B, Single Mode 40Km / LC/ Tx:1330nm Rx: 1270nm, 0°C~70°C (HP H3C Compatible)

Optional Accessories

- CBF-LC01LC-SS** LC to LC 1 Meter Single-Mode Simplex Fiber Cable

Assured Systems

Assured Systems is a leading technology company with over 1,500 regular clients in 80 countries, deploying over 85,000 systems to a diverse customer base in 12 years of business. We offer high-quality and innovative rugged computing, display, networking and data collection solutions to the embedded, industrial, and digital-out-of-home market sectors.

US

sales@assured-systems.com

Sales: +1 347 719 4508
Support: +1 347 719 4508

1309 Coffeen Ave
Ste 1200
Sheridan
WY 82801
USA

EMEA

sales@assured-systems.com

Sales: +44 (0)1785 879 050
Support: +44 (0)1785 879 050

Unit A5 Douglas Park
Stone Business Park
Stone
ST15 0YJ
United Kingdom

VAT Number: 120 9546 28
Business Registration Number: 07699660