

15" Digital Rod Displays

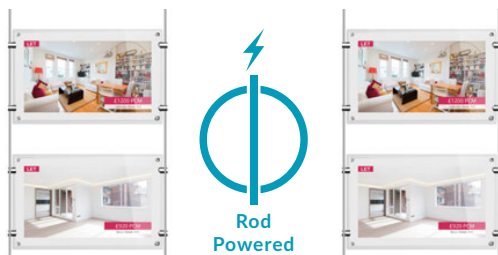

Rod Powered Displays











No mains cable is required to provide power as these innovative screens are powered via the rods on which they are mounted. Achieve a clean and seamless installation with no cables whatsoever for a modern and sleek feel.



Sunlight Readable Digital Light Pockets

Catch the attention of passers-by and potential customers with these 1,000cd/m² high brightness LCD digital light pockets. Ideal for combining with static light pockets in window displays to provide eye-catching motion alongside printed signage.



-  Ideal for Estate Agents
-  Rear Graphics Pocket
-  Android Media Player
-  LED Frame
-  Integrated Speakers
-  Temperature Control
-  Wide Viewing Angle
-  Free Scheduling Software
-  Multi-Screen Synchronisation
-  Network Upgrade

Other Features

Plug and Play

Plug and Play is the most straightforward way to upload content to the screen. Simply load images and videos onto a USB stick and insert into the display; your images and videos will now play in a continuous loop.

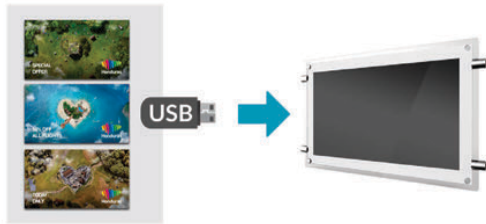

1,000cd/m² Commercial Panel

Brightness is paramount when using outward facing screens, these displays use commercial grade high brightness panels (1,000cd/m²); almost 4 times brighter than a standard home TV to allow easy readability in window displays.



Rear Graphics Pocket

On the rear of the display there is a pocket that a printed graphic can be inserted into to really maximise on the space used. This can be removed if necessary but comes as standard at no extra cost.



24/7 Usage

These displays use a commercial grade LCD panel and LED backlight. They have the ability to be in constant use 24/7 for over 70,000 hours and are designed for commercial use.



Exclusive Template Library

As well as being able to create your own layouts you can choose from our exclusive library of pre-design editable templates. Choose an existing layout, add your own images and information then publish it to your screen.



LED Frame

These displays have an attractive LED illuminated bevelled edge to compliment traditional static light pockets seamlessly.



Synchronise Multiple Displays

Synchronise your content across multiple screens in the same window display. You can achieve the effect of one large image or video across multiple screens or have content playing and transitioning in perfect unison.



Optional Network Upgrade

For a small charge you can upgrade your screen to be networked, allowing you to connect your screen via Wi-Fi, LAN or 4G, then remotely update it over the internet.



Key Features



ROD POWERED DISPLAYS



SUNLIGHT READABLE (1,000CD/M²)



LED FRAME



REAR GRAPHICS POCKET



ANDROID MEDIA PLAYER

PLUG AND PLAY

24/7 USAGE

OPTIONAL NETWORK UPGRADE

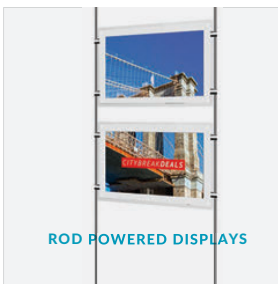

ROD POWERED DISPLAYS



SUNLIGHT READABLE

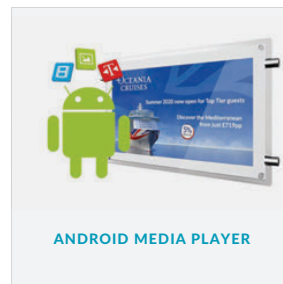

ANDROID MEDIA PLAYER

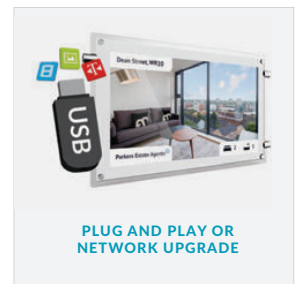

PLUG AND PLAY OR NETWORK UPGRADE

Specification Table

		15 Inch
Panel	Resolution	1920x1080
	Display Area (mm)	344x193.5
	Aspect Ratio	16:9
	Brightness (cd/m ²)	1000
	Colour	16.7M
	Viewing Angle	178°
	Contrast Ratio	5000:1
Audio	Speaker Type	5W, 8Ω (x2)
AV Inputs	Video	HDMI, VGA
	Audio	Audio Socket (3.5mm)
Power	Power Consumption (W)	16
	Input Voltage (with transformer)	12V (DC)
Mechanical	Unit Size (WxHxD mm)	430x280x49.2*
	Package Size (WxHxD mm)	510x360x185
	Net Weight (kg)	3.3
	Gross Weight (kg)	6.1
Environmental	Operating Temperature	0 °C to 50 °C
	Storage Temperature	-30°C to 60°C
	Operating Humidity	10% to 80%
	Storage Humidity	5% to 95%
Computer	Media Formats	Video (MPG, AVI, MP4, RM, RMVB, TS), Audio (MP3, WMA), Image (JPG, GIF, BMP, PNG)
	Media Resolution	1920x1080/1080x1920
	Internal Memory	6GB
	CPU	Quad-Core Cortex-A17@1.61GHz
	GPU	Mali-T760 MP4 @600MHz
	RAM	2GB DDR3
	ROM	8GB NAND
	USB	USB2.0 HOST (x2)
	LAN	10/100M Ethernet (Network Version Only)
	Wi-Fi	802.11b/g/n/ac (Network Version Only)
	OS	Android 5.1.1
	Graphic Engine	OpenGL ES 1.1/2.0/3.0/3.1, OpenCL 1.1, Renderscript, Direct3D 11.1
	Accessories	Included
Optional		Network Upgrade
Warranty	Warranty Period	3 Year Warranty
	Technical Support	Lifetime

*Includes Rear Graphics Pocket
Errors and omissions excepted

Compatible with Estate Agent Software

The Digital Rod Displays are compatible with a host of third party estate agent property management software.



Technical Drawing

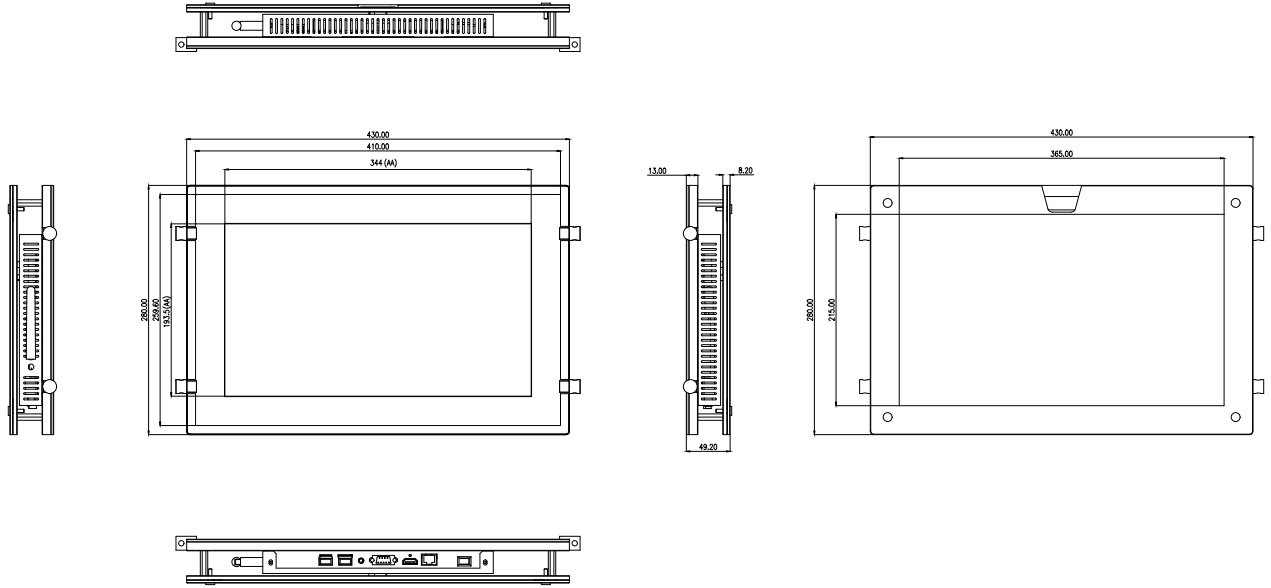

Assured Systems

Assured Systems is a leading technology company with over 1,500 regular clients in 80 countries, deploying over 85,000 systems to a diverse customer base in 12 years of business. We offer high-quality and innovative rugged computing, display, networking and data collection solutions to the embedded, industrial, and digital-out-of-home market sectors.

US

sales@assured-systems.com

Sales: +1 347 719 4508
Support: +1 347 719 4508

1309 Coffeen Ave
Ste 1200
Sheridan
WY 82801
USA

EMEA

sales@assured-systems.com

Sales: +44 (0)1785 879 050
Support: +44 (0)1785 879 050

Unit A5 Douglas Park
Stone Business Park
Stone
ST15 0YJ
United Kingdom

VAT Number: 120 9546 28
Business Registration Number: 07699660