

W22IB3S-SPA3-B, 21.5-inch Stainless B Series Panel PC

Stainless IP65 with Waterproof Connector Solutions

Push-buttons bring control and indication directly to the work area, eliminating wasted movement and increasing productivity. In addition, the physical buttons are especially needed for critical tasks like emergency shutdowns. When an emergency situation occurs, we don't want to waste time navigating through HMI screens but a simple and quick way to shut down the process. In terms of machine integration, push-button devices are easy to install and wire, and straightforward for understanding the function and use. Averagely the wiring time is saved by over 60%, and the installation cost is reduced by more than 30%.



Highlights

- Intel® Celeron® N2930 (2M Cache, up to 2.16 GHz)
- Fanless cooling system
- SUS 316 / AISI 316 stainless steel for food and chemical industries
- Full IP65 waterproof enclosure, good corrosion resistance
- A true flat, easy-to-clean front surface with edge-to-edge design
- Supports VESA mount
- Rotary switch adjust different touch mode for Hand/Rain/Glove application
- Emergency and Flat buttons for automation device control

W22IB3S-SPA3-B, 21.5-inch Stainless B Series Panel PC

Stainless IP65 with Waterproof Connector Solutions

Display Specification

Resolution	1920 x 1080
Contrast Ratio	3000:1
Brightness	250
Viewing Angle	89,89,89,89
Max Colors	16.7M
Touch	Projected capacitive multi touch screen

System Specification

CPU	Intel® Celeron® N2930 (2M Cache, up to 2.16 GHz)
System Chipset	Intel® SoC integrated
System Memory	1 x SODIMM, Max 8GB DDR3 1600 MHz, default 4GB
Storage	Default 1 x mSATA SSD 64GB
BIOS	AMI BIOS
Audio Codec	Realtek HD codec
Expansion	1 x mPCIe slot(for half size Wifi module)
Network	Intel® Ethernet Controller I210-AT
Operating System	Windows 10 IoT Enterprise

Interface

Ethernet LAN	1 x waterproof Giga LAN RJ45 connector
COM	1 x M12 waterproof connector for RS232
USB	1 x M12 waterproof connector for 2 x USB2.0 1 x Front waterproof connector for USB2.0 type-A
Power Input	1 x M12 waterproof connector for 12V DC
Expansion Port	CN1 and CN2 for front button control

Keyboard and Input

Physical Buttons	Rear side: 1 x Power Button 1 x Reset Button Front side: 1 x Emergency Button & 3 x Flat Button for CN1 & CN2 M12 connector 1 x Rotary Switch for touch mode
LED Indicators	1 x LED Indicator for power 1 x LED Indicator for storage

Power Management

Power Input	Default 12V DC input 9~36V DC input for optional*
AC Adapter	100~240V AC to DC Adapter with waterproof connector

Mechanical Specifications

Dimensions	595 x 337 x 69 mm
Housing	SUS 316/ AISI 316 stainless steel
Mounting	VESA Mount

Security Function

Security	TPM 2.0
----------	---------

Environment

Operating Temperature	0~45°C
Storage Temperature	-20~60°C
Operating Humidity	10% to 90% (Non-condensing)
IP Rating	IP65

Accessories

Standard Accessories

100~240V AC to DC Adapter with waterproof connector
Power Cord
External USB cable with waterproof connector
External COM cable with waterproof connector
External LAN cable with waterproof connector
External cables for CN1 & CN2 with waterproof connector
Waterproof caps
RJ45 female-female converter
Driver CD & Manual
VESA screws

Standards and Certification

EMC	CE, FCC
-----	---------

Drawing

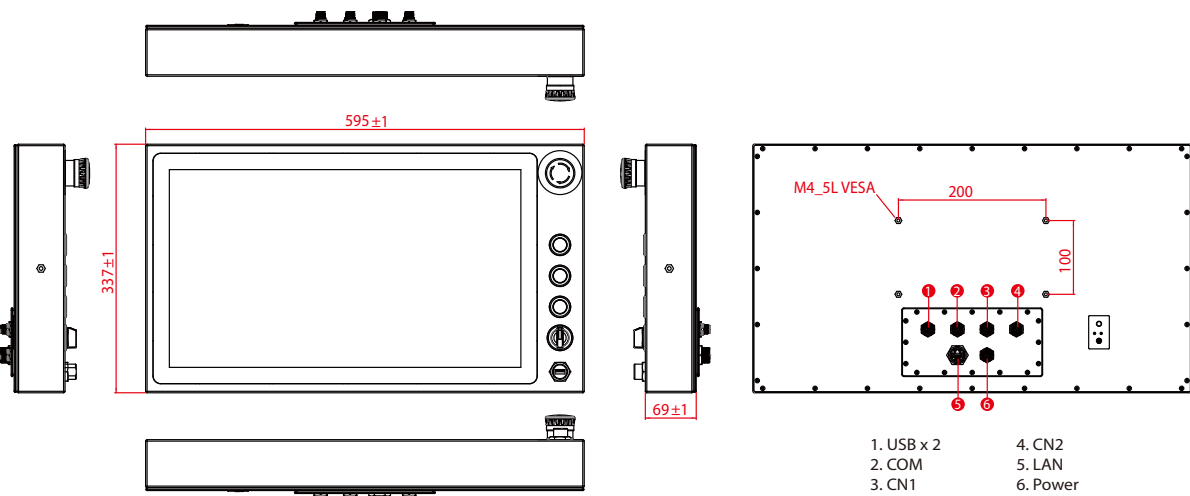

Note 1: Yoke mount stand kit is an optional accessory.
Note 2: Wi-Fi antenna is an optional feature.

W22IB3S-SPA3-B, 21.5-inch Stainless B Series Panel PC

Stainless IP65 with Waterproof Connector Solutions

Accessories

Power Cable

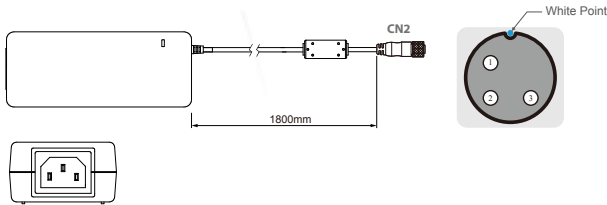

Pin No.	Symbols	Color	Pin No.	Symbols	Color
CN1-1	VIN -	NO ASSIGN	CN2-1	VCC+	Flow Adapter
CN1-2	VIN -	NO ASSIGN	CN2-2	GND	Flow Adapter
CN1-3	VIN -	NO ASSIGN	CN2-3	VCC -	Flow Adapter

LAN Cable

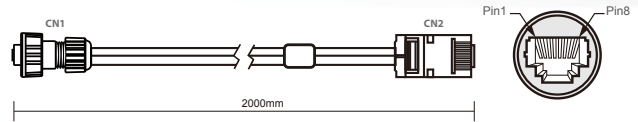

Plug	Wire Color	Conn.
1	Orange / White	1
2	Orange	2
3	Green / White	3
4	Blue	4
5	Blue / White	5
6	Green	6
7	Brown / White	7
8	Brown	8

Twist
Twist
Twist

RS232 Cable

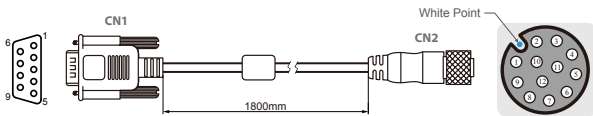

Pin No.	Symbols	Color	Pin No.	Symbols	Color
CN1-1	DCD-CON2	Green	CN2-1	DCD-CON2	Green
CN1-6	DSR-CON2	Brown	CN2-2	DSR-CON2	Brown
CN1-2	RXD-CON2	Red	CN2-3	RXD-CON2	Red
CN1-7	RTS-CON2	Orange	CN2-4	RTS-CON2	Orange
CN1-3	TXD-CON2	Blue	CN2-5	TXD-CON2	Blue
CN1-8	CTS-CON2	White	CN2-6	CTS-CON2	White
CN1-4	DTR-CON2	Purple	CN2-7	DTR-CON2	Purple
CN1-9	RI-CON2	Yellow	CN2-8	RI-CON2	Yellow
CN1-5	GND-CON2	Black	CN2-9	GND-CON2	Black

USB Cable

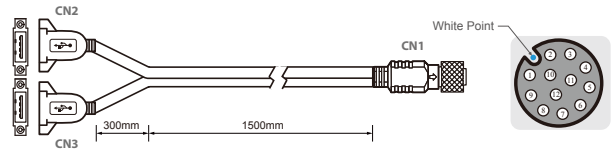

Pin No.	Symbols	Color	Pin No.	Symbols	Color
CN1-2	VCC	RED	CN2-1	VCC	RED
CN1-3	D-	WHITE	CN2-2	D-	WHITE
CN1-4	D+	GREEN	CN2-3	D+	GREEN
CN1-5	GND	BLACK	CN2-4	GND	BLACK
CN1-6	VCC	RED	CN3-1	VCC	RED
CN1-7	D-	WHITE	CN3-2	D-	WHITE
CN1-8	D+	GREEN	CN3-3	D+	GREEN
CN1-9	GND	BLACK	CN3-4	GND	BLACK
CN1-1	GND	Braid	Braid connect to the housing		

twisted pair
twisted pair

Push-button extension Cable for Connector 1

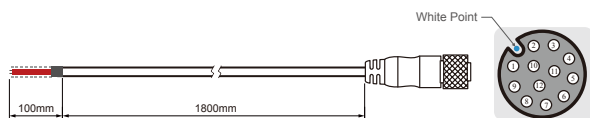

Pin No.	Symbols	Color
CN1-1	Emergency NC 2	Emergency Stop
CN1-2	Emergency NC 1	
CN1-3	Emergency NC 2	
CN1-4	Emergency NC 1	
CN1-5	Blue NO 4	Blue Button
CN1-6	Blue NO 3	
CN1-7	Blue NC 2	
CN1-8	Blue NC 1	
CN1-9		
CN1-10	N/A	
CN1-11		
CN1-12		

Push-button extension Cable for Connector 2

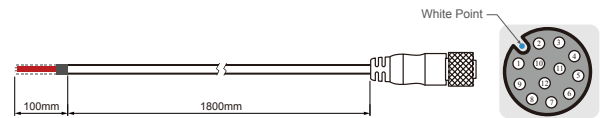

Pin No.	Symbols	Color
CN2-1	Red NO 4	Green Button
CN2-2	Red NO 3	
CN2-3	Red NC 2	
CN2-4	Red NC 1	
CN2-5	Green NO 4	Red Button
CN2-6	Green NO 3	
CN2-7	Green NC 2	
CN2-8	Green NC 1	
CN2-9		
CN2-10	N/A	
CN2-11		
CN2-12		

Assured Systems

Assured Systems is a leading technology company with over 1,500 regular clients in 80 countries, deploying over 85,000 systems to a diverse customer base in 12 years of business. We offer high-quality and innovative rugged computing, display, networking and data collection solutions to the embedded, industrial, and digital-out-of-home market sectors.

US

sales@assured-systems.com

Sales: +1 347 719 4508
Support: +1 347 719 4508

1309 Coffeen Ave
Ste 1200
Sheridan
WY 82801
USA

EMEA

sales@assured-systems.com

Sales: +44 (0)1785 879 050
Support: +44 (0)1785 879 050

Unit A5 Douglas Park
Stone Business Park
Stone
ST15 0YJ
United Kingdom

VAT Number: 120 9546 28
Business Registration Number: 07699660