

VES30-8S

8 + 1 Gigabit Ethernet Switch with 8-Port PoE



Main Features

- 8 x 10/100/1000 Mbps PoE port (802.3af compliance)
- 15.4W at 48VDC for each PoE port
- Low battery voltage protection
- CE/FCC, E13 mark certification
- Wide power input range 9 ~ 36VDC
- -30 ~ 70°C operating temperature
- Ignition power on/off support
- Power on/off delay time setting

Product Overview

VES30-8S mobile PoE switch is designed for telematics applications in harsh environments with fanless enclosure. It provides 9 Giga bit Fast Ethernet ports including 8 IEEE 802.3af compliance PoE ports to transfer large amounts of video streaming, voice and critical data across Ethernet network smoothly and quickly.

As the power source from a vehicle is unstable by nature, the mobile PoE switches support a wide voltage input range of 9VDC to 36VDC and provide smart power management with low battery voltage protection, power-on and power-off delay timer, and auto ignition power on/off functions. These unique features can secure reliable operation and prevent premature failure of both the PoE switches and vehicle.

VES30-8S is encased in a fanless dustproof enclosure and can operate under shock, vibration, and temperature extremes from -30 to 70°C. The mobile PoE switches are also small in size and support din rail mounting for ease of installation with PD devices such as IP cameras and Wi-Fi access points.

Specifications

Architecture

- Switch architecture. Highly integrated, unmanaged-smart gigabit, store and forward switch
- 4K entry MAC address table with automatic learning and aging

Power over Ethernet

- PoE standard IEEE 802.3af Power over Ethernet/PSE
- PoE power supply type end-span
- PoE power output per port 48V DC, 350mA. max. 15.4 watts

Network Connector

- 8-port RJ45 for 10/100/1000 base-T. PoE IEEE 802.3af compliance, total 120W
- 1-port RJ45 for 10/100/1000 base-T

Standard Compliance

- IEEE 802.3 for 10BaseT Ethernet
- IEEE 802.3u for 100BaseT(X) Fast Ethernet
- IEEE 802.3ab for 1000BaseT(X) Gigabit Ethernet
- IEEE 802.3x for flow control
- IEEE 802.3af Power Over Ethernet

I/O Interface

- Power: 1 x 9~36VDC input with ignition
- Ethernet
 - 8 x RJ45 10/100/1000 Mbps PoE port, 802.3af compliance
 - 1 x RJ45 10/100/1000 Mbps
- LED
 - 1 x power indicator
 - 8 x PoE indicator
 - 1 x low voltage protection indicator

Power Management

- Selectable boot-up & shut-down voltage for low power protection by Dip switch
- Power on/ off delay time setting by Dip switch

Dimensions

- 167 x 51.49 x 139.6 mm (65.75" x 20.27" x 54.96")
- Weight: 1kg
- Support Horizontal Mounting, DIN- Rail Mounting (option) and vertical Mounting (option)

www.nexcom.com



Dimension Drawing

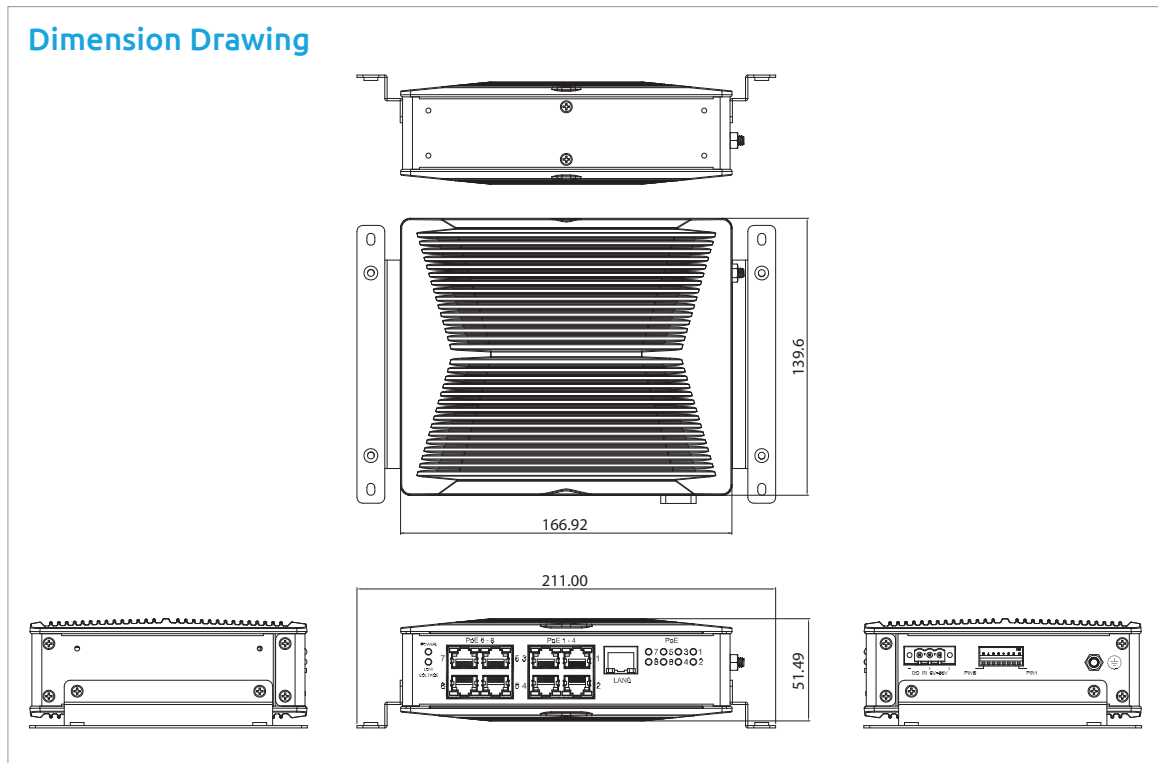

Environment

- Operating temperatures: Ambient with air -30°C to 70°C
- Storage temperatures: -35°C to 85°C
- Relative humidity: 10% to 90% (non-condensing)
- Vibration (random): 1g@5~500 Hz
- Vibration:
 - Operating: MIL-STD-810G, Method 514.6, Category 4, common carrier US highway truck vibration exposure
 - Storage: MIL-STD-810G, Method 514.6, Category 24, minimum integrity test
- Shock:
 - Operating: MIL-STD-810G, Method 516.6, Procedure I, functional shock=20g
 - Non-Operating: MIL-STD-810G, Method 516.6, Procedure V, crash hazard shock test=75g

Standards/Certifications

- CE approval
- FCC Class B
- E13 Mark

Ordering Information

- **VES30-8S (P/N: 10VE0003001X0)**
8 x RJ45 10/100/1000 PoE port (802.3af), 1 x RJ45 10/100/1000 Ethernet port, 9 ~ 36VDC input, ignition detection, low voltage protection, delay timer, E13 mark

Assured Systems

Assured Systems is a leading technology company with over 1,500 regular clients in 80 countries, deploying over 85,000 systems to a diverse customer base in 12 years of business. We offer high-quality and innovative rugged computing, display, networking and data collection solutions to the embedded, industrial, and digital-out-of-home market sectors.

US

sales@assured-systems.com

Sales: +1 347 719 4508
Support: +1 347 719 4508

1309 Coffeen Ave
Ste 1200
Sheridan
WY 82801
USA

EMEA

sales@assured-systems.com

Sales: +44 (0)1785 879 050
Support: +44 (0)1785 879 050

Unit A5 Douglas Park
Stone Business Park
Stone
ST15 0YJ
United Kingdom

VAT Number: 120 9546 28
Business Registration Number: 07699660