

10" POS Android Advertising Displays



Plug and Play







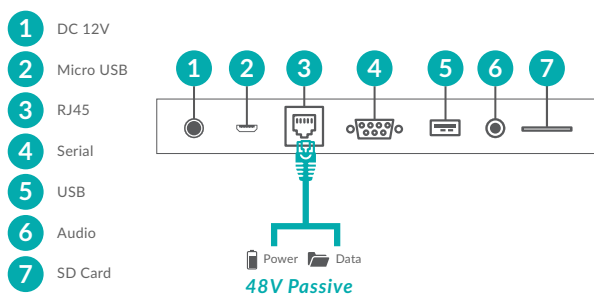

Plug and Play is the most straightforward way to upload content to the screen. Simply load images and videos onto a USB stick, insert into the display, wait for your content to copy over and then remove. Your images and videos will now play in a continuous loop.



Power Over Ethernet (PoE)

Power your screen by using the cable provided or supply the power over an Ethernet cable. This minimises the number of cables needed for installation as you can supply power and internet connectivity to the screen simultaneously.



-  Android Media Player
-  Optional NFC Usage
-  Headphone Output
-  No Integrated Battery
-  Integrated VESA Mounting Holes
-  Free Security Wall Mount
-  Extend Memory with SD Card
-  Additional Colours Available

Other Features

24/7 Commercial Use

These displays use a commercial grade LCD panel and LED backlight. They have the ability to be in constant use 24/7 for over 70,000 hours and have no external buttons or controls to avoid tampering.



No Integrated Battery

Unlike domestic tablets these displays do not have built-in batteries and therefore last considerably longer. They are designed to be used constantly 24/7 in public spaces and can be powered directly from the mains or over PoE.



VESA Mounting Holes

Unlike domestic tablets these displays have an integrated and secure screw based mounting solution on the rear for easy wall or stand installation.

75 x 75
VESA



Multi Coloured LED Frame

The LED edges either side of the display can be red, green or blue. They can also be disabled completely if preferred.



Available in 3
Colours

Integrated Camera

If the software you are using requires a camera you can use the screen's integrated front facing 2 megapixel camera.

2 Megapixel Camera



Power Timer

The eco-friendly power timer allows you to assign daily or weekly on and off times for your screen meaning that it is only in use when it needs to be; improving your environmental efficiency.



Optional Network Upgrade

For a small charge you can upgrade your screen to be networked, allowing you to connect your screen via Wi-Fi, LAN or 4G, then remotely update it over the internet.

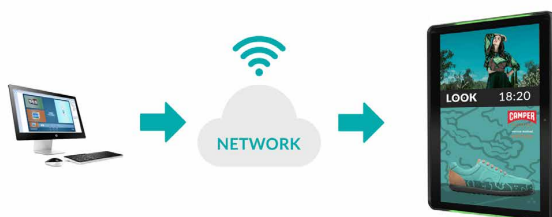

Touch Screen Upgrade

You can upgrade your display to be a PCAP touch screen to add the element of interactivity; increasing audience engagement.



Key Features



PLUG AND PLAY



INTEGRATED CAMERA



LANDSCAPE OR PORTRAIT ORIENTATION



24/7 COMMERCIAL GRADE



INTEGRATED SPEAKERS



ANDROID MEDIA PLAYER



HEADPHONE OUTPUT



MULTI-COLOUR LED FRAME



POE

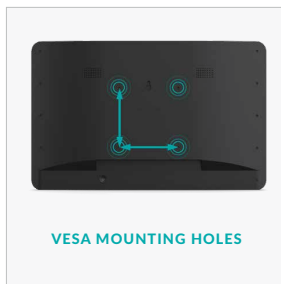

VESA MOUNTING HOLES

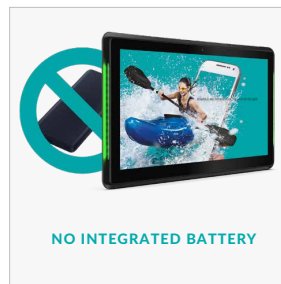

NO INTEGRATED BATTERY

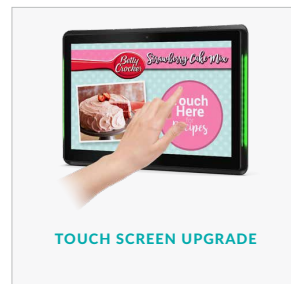

TOUCH SCREEN UPGRADE

Specification Table

		10 Inch
Panel	Resolution	1280x800
	Display Area (mm)	216.96x135.6
	Aspect Ratio	16:10
	Brightness (cd/m ²)	450
	Colour	16.7M
	Colour Depth	10 Bit
	Viewing Angle	178°
	Contrast Ratio	800:1
Audio	Speaker Type	2x2W
AV Inputs	Video	Micro USB, 1x USB 3.0, 1x USB 2.0
	Audio	Audio Socket (3.5mm)
Power	Power Consumption (W)	TBC
	Input Voltage	12V/2A
	PoE Mode	48V Passive
Mechanical	Unit Size (WxHxD mm)	273.7x189.7x30.2
	Package Size (WxHxD mm)	368x234x75
	VESA Holes (mm)	75x75
	Net Weight (kg)	0.75
	Gross Weight (kg)	1.15
Environmental	Operating Temperature	0 °C to 50 °C
	Storage Temperature	-30°C to 60°C
	Operating Humidity	10% to 80%
	Storage Humidity	5% to 95%
Computer	Media Formats	Video (MPG, AVI, MP4, RM, RMVB, TS), Audio (MP3, WMA), Image (JPG, GIF, BMP, PNG)
	Media Resolution	1920x1080/1080x1920
	CPU	Quad-core Cortex-A17 1.8GHz,RockChip RK3288
	GPU	Mali-T764
	RAM	2GB
	ROM	16GB
	Storage Extension	SD Card
	USB	USB3.0 HOST x1
	Wi-Fi	802.11b/g/n
	OS	Android 8.1
Accessories	Included	Wall Mount
	Optional	Network Upgrade, PCAP Touch Screen Upgrade, Table Stand, Near Field Communication
Warranty	Warranty Period	3 Year Warranty
	Technical Support	Lifetime

Errors and omissions excepted

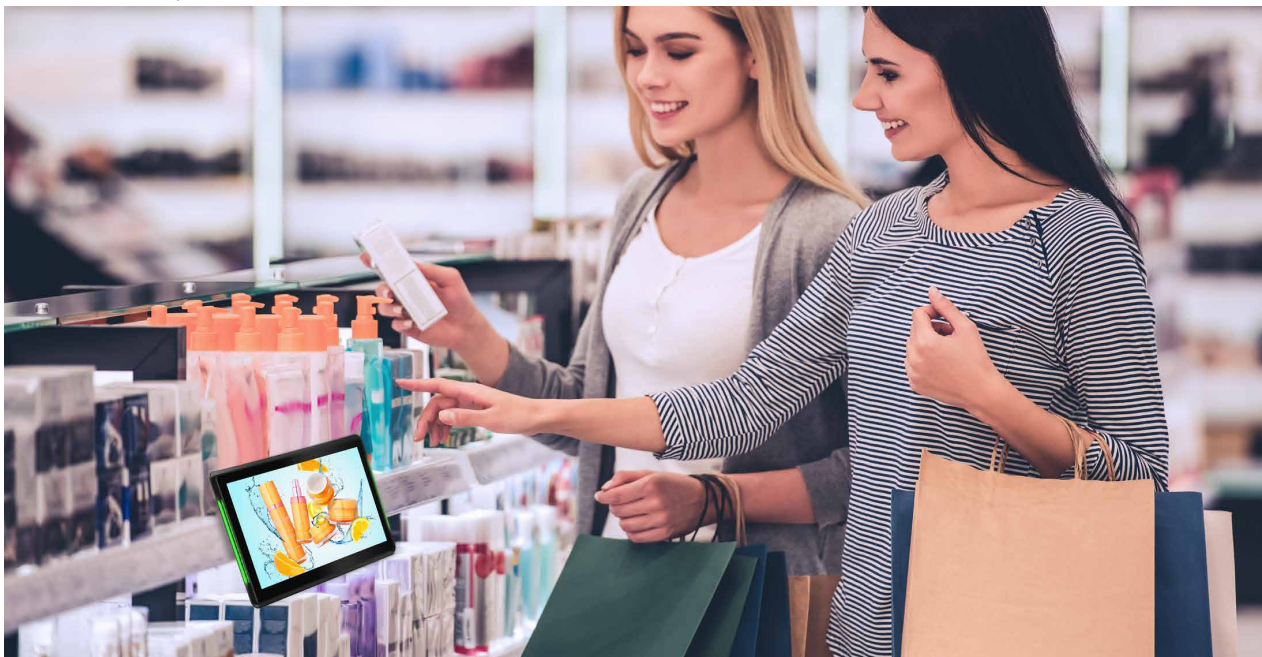

Technical Drawing

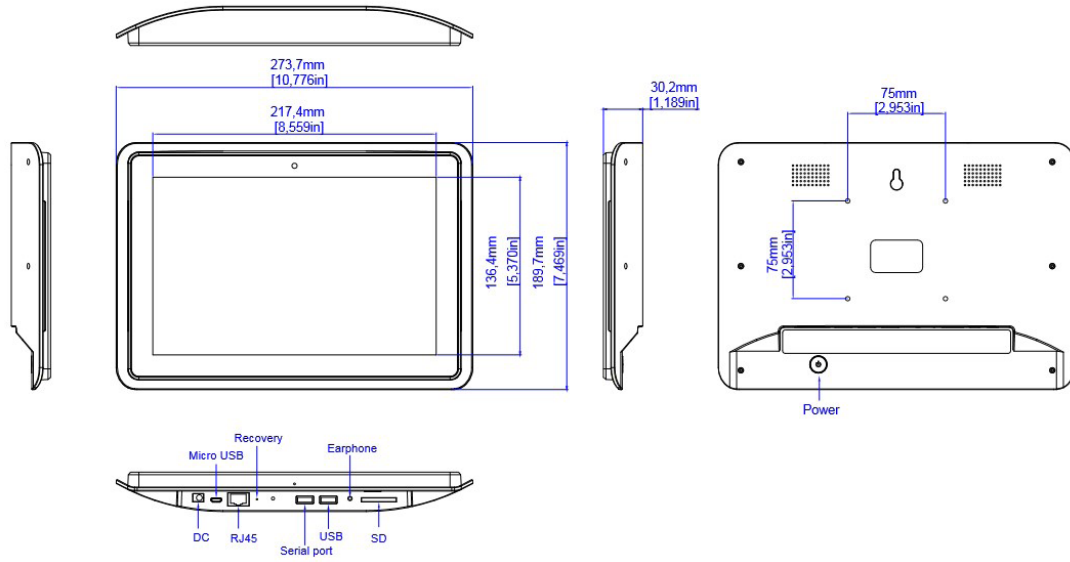

Assured Systems

Assured Systems is a leading technology company with over 1,500 regular clients in 80 countries, deploying over 85,000 systems to a diverse customer base in 12 years of business. We offer high-quality and innovative rugged computing, display, networking and data collection solutions to the embedded, industrial, and digital-out-of-home market sectors.

US

sales@assured-systems.com

Sales: +1 347 719 4508
Support: +1 347 719 4508

1309 Coffeen Ave
Ste 1200
Sheridan
WY 82801
USA

EMEA

sales@assured-systems.com

Sales: +44 (0)1785 879 050
Support: +44 (0)1785 879 050

Unit A5 Douglas Park
Stone Business Park
Stone
ST15 0YJ
United Kingdom

VAT Number: 120 9546 28
Business Registration Number: 07699660