



86" Interactive Touch Display



*UK Mainland Only

Overview

Stunning Enclosure

The flawless enclosure is crafted from black aluminium and assembled in segments so the enclosure can remain sexy and sleek with its rounded corners. It also has a polymer rear cover to keep it super slim and lightweight.

Connectivity

The rear of the screen features AV inputs that allow for more permanent connections such as AV in and out, Audio in and out, RS-232, VGA, DP, SPDIF, HDMI, YPbPr, USB.



Etched Glass

Improves tactility for smooth touch gestures. The anti-glare nano coating also diffuses external light so that images and videos are much clearer.

Built-in Android PC

Featuring a powerful integrated PC running Android 5.0 with 2GB RAM and 16GB ROM.

10-Point Infrared Touch Technology

Using the most durable and robust commercial touch technology available. Use anything such as your finger, or one of the styluses included, as your pointer.

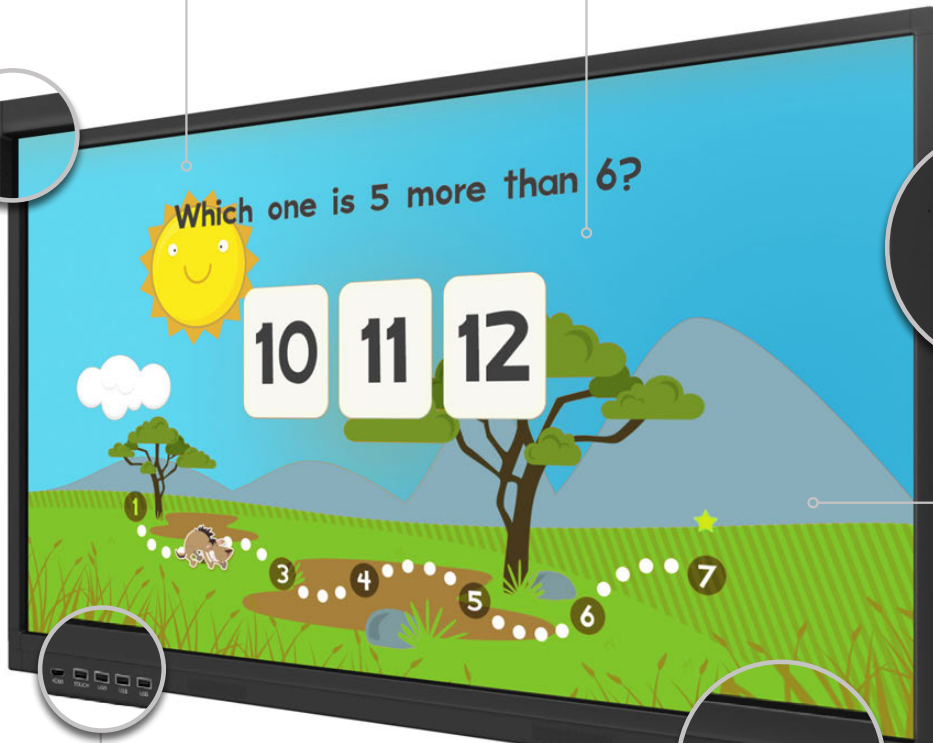

Power/Menu Buttons



Free MeetingPad Software

State of the art 'MeetingPad' Software brings the Interactive Touch Display to life. No additional hardware is required as you wireless mirror and fileshare between your devices and the screen. The wireless features are all compatible with Android, Apple and Windows devices and even allow you to annotate the screen from your device.

Stylus Set Included

Two special 'Smart Pens' are included as well as an extendable pointer and two extra magnetic styluses for free.



Optional OPS PC

For a seamless solution an OPS PC can be integrated into the rear of the display. This allows you the flexibility to choose between Android and Windows and switch effortlessly between the two. Available with a cost effective OPS PC or a more powerful OPS PC.













LED Backlight

The long lasting eco-friendly LED backlight focuses on optimum brightness and contrast; causing no eye strain as you would get from projectors. The panel and backlight have a lifespan in excess of 80,000 hours.

Freeze Frame Function

While your laptop is connected you can freeze the image on screen so that you can continue to work independently on your laptop.

-  Integrated Android PC
-  Optional OPS PC
-  16GB
Integrated 16GB Storage
-  10 Touch Points
-  5 Year
Onsite Warranty
(UK Mainland Only)
-  No Shadow
-  5-GHz Integrated Wi-Fi
-  Low Power Consumption
-  Anti-glare Glass
-  LED Backlight
-  VGA, HDMI, AV, Audio, YPbPr, RS-232, DisplayPort, SPDIF & USB Connectivity

Free MeetingPad Software



Multiplatform Compatibility

Android, Apple and Windows devices are compatible to connect with 'MeetingPad'

Wireless Mirroring

Connect to the Touch Screen from any smartphone, tablet, laptop, PC or Mac wirelessly. Using mobile devices you can mirror the display in both directions, and even take control of the Touch Screen, from anywhere on the same Wi-Fi network. Mirroring via 5GHz allows users the best wireless experience available with fast mirroring and less interference. All of this without the need of additional wires or transmitters.

File Sharing

Once your device and the Touch Screen are wirelessly connected you can quickly and easily share content to and from your device. Use the Eshare app to show videos, images and audio files stored on your smartphone, tablet, laptop or PC. You can also share files from the Touch Screen to your device using various methods such as email or scanning a QR code. Files can easily flow between the Touch Screen and your devices.

No Additional Hardware Required

Wirelessly mirror and share files straight from your device without the need for any additional hardware, such as transmitters or wires. However there is a handy Touch Screen Projection Dongle USB included that makes mirroring from your PC or Mac fast and simple, without the need to install any software.

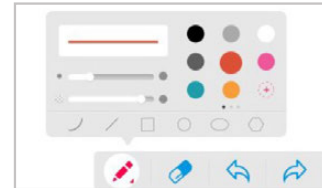

Flexible Working Tools

Personalise your experience by changing the background colour of the display, as well as the colour, thickness and opacity of the lines with your drawing tools.

Whiteboard

Replaces the traditional marker board in meeting rooms and classrooms. Annotate, draw and create meeting magic with the ultimate presentation tool.

Unlimited Connections

There is no limit to the amount of mobile devices that can simultaneously connect wirelessly to the screen.

Snipping Tool

Crop segments of the display to shift focus to more important sections of documents, screenshots or webpages.

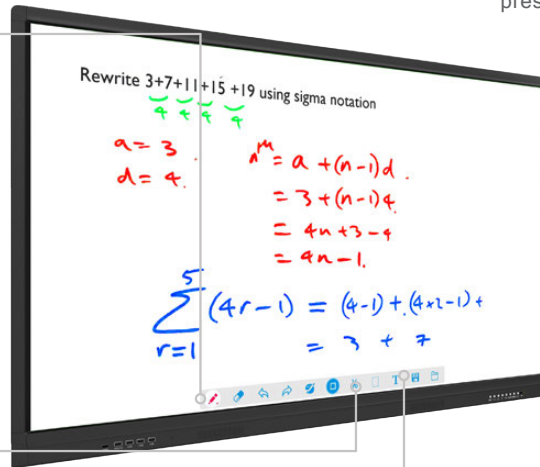

Annotations

Make notes on your existing documents, screenshots and even webpages. Expand and innovate your content with ideas and concepts.

Web Browser

Surf the web with the integrated internet browser.

Scrolling Text

The marquee text tool is fun and innovative way to make important messages stand out, such as setting up welcome messages for your visitors.

Smart Pen Stylus

There are two interactive 'Smart Pens' included. These special styluses allows you to control the display wirelessly from anywhere in the room. You can change the pen tool colour, save annotated documents, navigate through a PowerPoint presentation and go back to the 'MeetingPad' home screen.

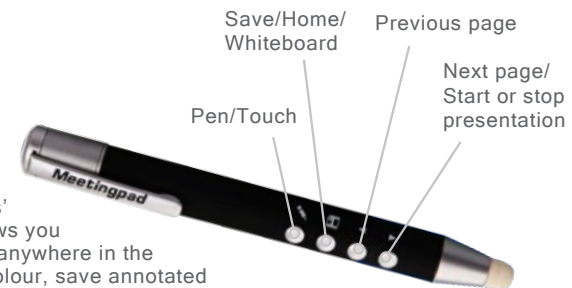



Full Android Control

Experience the Android revolution with the powerful integrated Android PC that runs everything. Preview and switch between external sources and even annotate over images, presentations, documents and webpages - either running from the 'MeetingPad' or from external devices. Our innovative 'MeetingPad' solution controls all functions allowing you to achieve state of the art interactive whiteboard functionality. Show videos, play music, and even run your apps; 'MeetingPad' brings the power to change your meetings forever to your fingertips.

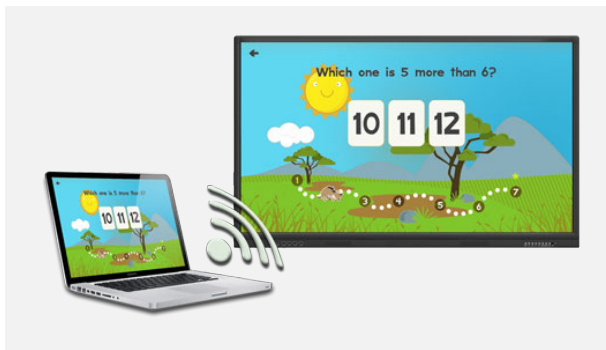

Wireless Mirroring

Mirror what is on your Windows, Android or Apple device without the need for messy cables with the wireless mirroring feature this display offers. Great for presenting and sharing content during meetings it is done using your devices native streaming platform - Screen Mirroring for Android, Miracast for Windows and AirPlay for Apple. Mirroring the display from your mobile, tablet or laptop has never been easier.

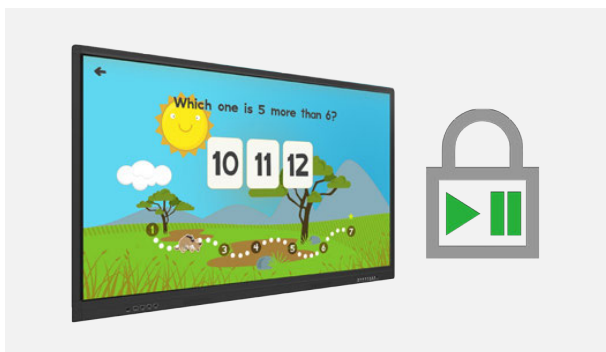

Freeze-Frame Function

If you are running the Interactive Touch Display from your laptop you can "freeze" the content mirrored from your device, This allows you to use unplug your laptop and use it independently from the screen with the content still being on display.



Optional Windows OPS PC

Experience the best of both worlds with an upgrade to add a Windows OPS PC directly into the rear of your Interactive Touch Display. Having the world most popular operating system in Windows just a switch away from our 'MeetingPad' software offers the best in flexible working. Upgrading allows you to save space and avoid a tangle of messy wires that you use to get with attaching other laptops or PCs to your Interactive Touch Display.



Features

10 Point Touch



Having up to 10 touch points allows for a wider variety of applications than ever before. This kind of functionality allows you to manipulate images, zoom in an out as well as perform many other touch gestures; much like you would with a smartphone or tablet. It also allows for multiple users interacting with the screen at one time, ideal for group interaction and learning.

Replace Projectors



Now is the time to replace old fashioned projector systems with an Interactive Touch Display that has a series of advantages over the antiquated presentation technology. Built to last over 16 times longer than a projector bulb and with drastically improved contrast and sharpness the images quality does not compare. There are also no annoying shadows cast on the display that you have with projectors.

LED Backlight



The LED backlight used is not only eco-friendly but also ensures the display has enhanced brightness and contrast. This technology increases the lifespan and reduces the power consumption by around 30%. This form of light technology is mercury free; safeguarding this screen's eco friendliness.

Easy Access Ports and Controls

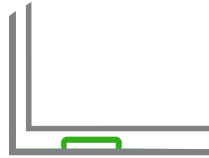

If you don't want to use the internal PC you can conveniently connect a laptop, or another external device, to the display's front ports. For more permanent connections there are a variety of AV inputs on the rear of the unit. The display also has clearly labelled buttons on the front face.

Built in 'MeetingPad' Software



Bundled with the screen is an easy to use meeting software program. Designed specifically for use with our Interactive Touch Displays this program combines the annotation style of traditional whiteboards with the convenience modern technology allows. You can read, write, edit, compare and most importantly annotate a variety of images, videos, PDF's, Office documents (Word, Excel, and PowerPoint) simultaneously.

Etched Anti-Glare Glass

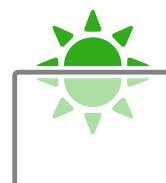

The etched glass diffuses the light, increasing the clarity of the screen and makes text and images much more legible even in areas with strong light. The display's anti-glare nano coating improves scratch and impact resistance of the screen as well as improving tactility; essential for group interactivity.

Panel	Display Size	86 inch
	Resolution	3840x2160
	Display Area (mm)	1895x1066
	Aspect Ratio	16:9
	Brightness (cd/m2)	500
	Colour	16.7 million
	Colour Depth	8 Bit
	Viewing Angle	178°
	Contrast Ratio	5000:1
Touch	Lifespan	80,000 Hours
	Touch Technology	Infrared
	Touch Points	10
	Glass Hardness	7H minimum
	Response Time	≤5ms
	Touch Point Accuracy	±1.5mm
Audio	Touch Resolution	32768x32768
	Speaker Output	15W, 8Ω (x2 Front)
	Front Inputs	Touch USBx1, HDMI x1, USB x3
AV Inputs/Outputs	Side Inputs	DisplayPort, Touch USB, HDMI x 2, VGA, Audio In, USB 3.0 x 2, AV In, YPbPr, SD Card, RS232
	Outputs	AV Out, Audio Out, SPDIF
	Power Supply	AC110~240V (50Hz~60Hz)
Power	Unit Size (WxHxD mm)	2018.4x1227.95x117.9
	Package Size (WxHxD mm)	2330x1685x525
	VESA Holes (mm)	600x400
	Net Weight (kg)	82.85
	Gross Weight (kg)	190
	Mechanical	Operating Temperature
Storage Temperature		-30°C to 60°C
Operating Humidity		10% to 80%
Storage Humidity		5% to 95%
Environmental	CPU	ARM Quad-core Cortex-A53 1.4GHz
	RAM	2GB DDR3
	Architecture	64-bit
	Graphic Engine	Mali450MP4 (6-core) 450MHz
	Hard Drive/Internal Memory (eMMC)	16GB
	USB	USB 3.0 x 2, USB 2.0 x3
	LAN	10/100 Ethernet
	Wi-Fi	802.11b/g/n/ac
	OS	Android 5.0.1
Computer	Included	User Manual (CD), Remote Control, Power Cable, LAN Cable, USB A Male to USB A Male Cable(x1), USB A Male to USB B Male Cable (x1), Wi-Fi Aerial (x2), HDMI Cable, Magnetic Whiteboard Pen (x 2), Smart Pen (x2), Telescopic Pointer (x1), USB Screen Projection Dongle (x2)
	Optional	Wall Mount, Floor Stand/Trolley, Ceiling Mount

Technical Drawing:

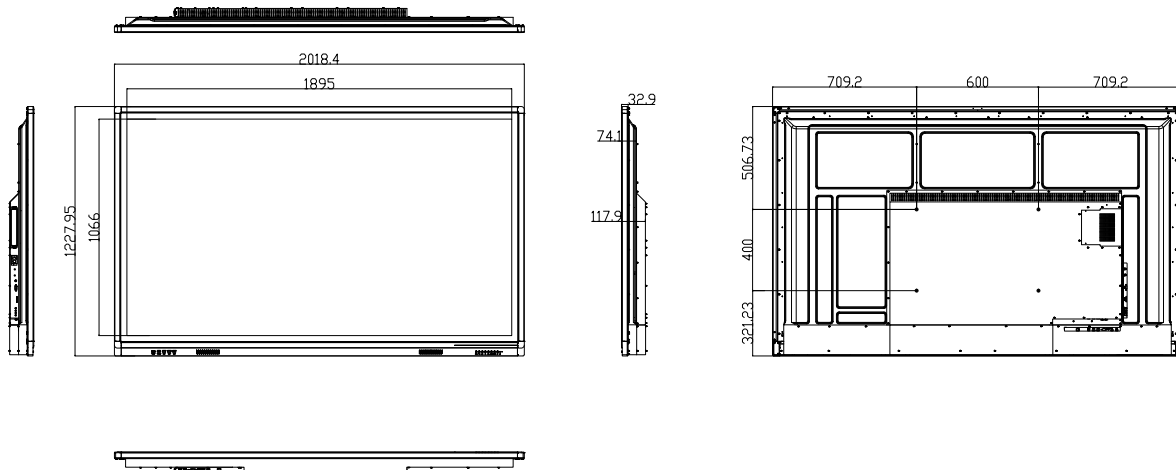

Errors and omissions excepted

Assured Systems

Assured Systems is a leading technology company with over 1,500 regular clients in 80 countries, deploying over 85,000 systems to a diverse customer base in 12 years of business. We offer high-quality and innovative rugged computing, display, networking and data collection solutions to the embedded, industrial, and digital-out-of-home market sectors.

US

sales@assured-systems.com

Sales: +1 347 719 4508
Support: +1 347 719 4508

1309 Coffeen Ave
Ste 1200
Sheridan
WY 82801
USA

EMEA

sales@assured-systems.com

Sales: +44 (0)1785 879 050
Support: +44 (0)1785 879 050

Unit A5 Douglas Park
Stone Business Park
Stone
ST15 0YJ
United Kingdom

VAT Number: 120 9546 28
Business Registration Number: 07699660