

# DA-1200

Intel Alder Lake-N Processor N97 Rugged Embedded Computer

## POWERFUL & TINY

DA-1200, a Rugged & Cost-effective Intel Alder Lake-N Computer



### Overview

[CONTACT](#)

The palm-sized DA-1200, equipped with an Intel® N97 processor (Alder Lake-N platform), is the smallest and an affordable model in the DIAMOND product line. It inherits the rugged features consistent throughout the Cincoze lineup and has passed or complies with many international certification standards, such as EMC standards in industrial environments (IEC 61000-6-2 and IEC 61000-6-4) and US military shock vibration standards (MIL-STD-810H). The DA-1200 is best for IoT gateway applications in smart manufacturing, smart logistics, and factory automation.

### Key Features

- Onboard Intel® Alder Lake-N Processor N97
- Ultra Compact Size (150 x 105 x 52.3 mm)
- 1 x DDR5 SO-DIMM Sockets, Supports Up to 4800MHZ, 16GB
- 1 x M.2 Key B Type 3052/3042 Socket for 5G/Storage/Add-on Card Expansion
- 1 x M.2 Key B Type 2242 Socket for Storage/Add-on Card Expansion
- Optional CMI modules for I/O expansion
- Wide Operating Temperature -40°C to 70°C

### Certifications



### Palm-Sized

The DA-1200 measures 150 x 105 x 52.3 mm and can fit in the palm of your hand.

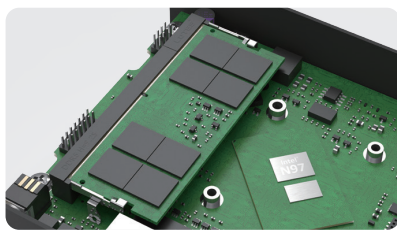

### Affordable High Performance

The DA-1200 has an Intel® N97 processor based on the Intel® 7 process and up to 16GB of DDR5 memory, giving it excellent overall performance at a highly competitive price.

### Easy Maintenance

Setup and adjustment of the DA-1200 is quick because key buttons and functions, including the reset switch, clear CMOS switch, AT/ATX switch, and SIM card slot, are all accessible on the front panel maintenance area.

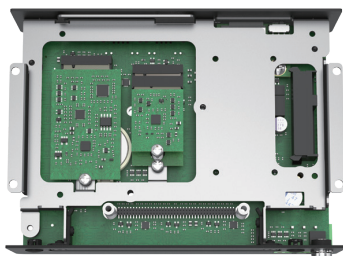

### Modular Expansion

The DA-1200 has two M.2 Key B slots (convertible to Key E with an optional M.2 Key B Adapter Card) for wireless cards (5G, Wi-Fi, and GNSS) and storage options that include 2.5" SSD, half-slim SSD, and M.2 SSD.

### Various Installation

The DA-1200 supports various mounting methods, including wall mount, side mount, and DIN Rail mount, for installation in various applications.

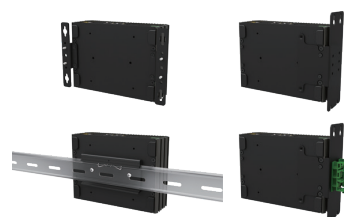

## Specifications

Model Name	DA-1200
<b>System</b>	
Processor	<ul style="list-style-type: none"> <li>Onboard Intel® Alder Lake-N Processor N97 Quad Core, up to 3.6 GHz</li> </ul>
Memory	<ul style="list-style-type: none"> <li>1x DDR5 SO-DIMM Socket</li> <li>Supports DDR5 4800MHz Memory Up to 16GB (un-buffered and non-ECC)</li> </ul>
BIOS	<ul style="list-style-type: none"> <li>AMI BIOS</li> </ul>
<b>Graphics</b>	
Graphics Engine	<ul style="list-style-type: none"> <li>Integrated Intel® UHD Graphics</li> </ul>
Maximum Display Output	<ul style="list-style-type: none"> <li>Supports Two Independent Display (Onboard 1x DisplayPort + Optional CMI 1x Display)</li> </ul>
DP	<ul style="list-style-type: none"> <li>1x DisplayPort Connector (4096 x 2304 @ 60Hz, According to CPU Specifications)</li> <li>* Verified maximum resolution: 3840 x 2160 @60Hz</li> </ul>
<b>I/O</b>	
LAN	<ul style="list-style-type: none"> <li>2x 2.5 GbE LAN, RJ45</li> <li>- GbE1: Intel® I225</li> <li>- GbE2: Intel® I225</li> </ul>
USB	<ul style="list-style-type: none"> <li>2x 10Gbps USB 3.2 Gen2 x1, Type A</li> </ul>
<b>Storage</b>	
SSD/HDD	<ul style="list-style-type: none"> <li>1x 2.5" SATA HDD/SSD or 1x Half-Slim SSD (SATA 3.0)</li> </ul>
M.2 SSD	<ul style="list-style-type: none"> <li>1 x M.2 SSD shared by M.2 Key B Type 3052 Socket, Support NVMe SSD (PCIe Gen 3x1) or SATA SSD (SATA 3.0)</li> <li>1 x M.2 SSD shared by M.2 Key B Type 2242 Socket, Support NVMe SSD (PCIe Gen 3x2)</li> </ul>
<b>Expansion</b>	
M.2 Key B Socket	<ul style="list-style-type: none"> <li>1x M.2 Key B Type 3042/3052 Socket, Support 5G/Storage/Add-on Card Expansion</li> <li>1 x M.2 Key B Type 2242, Support Storage/Add-on Card Expansion</li> </ul>
SIM	<ul style="list-style-type: none"> <li>1 x Front Accessible SIM Socket</li> </ul>
CMI (Combined Multiple I/O) Interface	<ul style="list-style-type: none"> <li>1x CMI Interface for optional CMI Module Expansion</li> </ul>
<b>Other Function</b>	
Clear CMOS Switch	<ul style="list-style-type: none"> <li>1x Clear CMOS Switch</li> </ul>
Reset Button	<ul style="list-style-type: none"> <li>1x Reset Button</li> </ul>
Instant Reboot	<ul style="list-style-type: none"> <li>Support 0.2sec Instant Reboot Technology</li> </ul>
Watchdog Timer	<ul style="list-style-type: none"> <li>Software Programmable Supports 256 Levels System Reset</li> </ul>
Antenna	<ul style="list-style-type: none"> <li>2x Antenna Holes</li> </ul>
<b>Power</b>	
Power Button	<ul style="list-style-type: none"> <li>1x ATX Power On/Off Button</li> </ul>
Power Mode Switch	<ul style="list-style-type: none"> <li>1x AT/ATX Mode Switch</li> </ul>
Power Input	<ul style="list-style-type: none"> <li>9 - 48VDC, 3-pin Terminal Block</li> </ul>
Remote Power On/Off	<ul style="list-style-type: none"> <li>1x Remote Power On/Off, 2-pin Terminal Block</li> </ul>
Remote Power LED	<ul style="list-style-type: none"> <li>1x Remote Power LED, 2-pin Terminal Block</li> </ul>

<b>Physical</b>	
Dimension ( W x D x H )	• 150 x 105 x 52.3 mm
Weight Information	• 0.81 kg
Mechanical Construction	• Extruded Aluminum with Heavy Duty Metal
Mounting	• Wall / Side / DIN-RAIL / VESA Mount
Physical Design	<ul style="list-style-type: none"> <li>• Fanless Design</li> <li>• Cableless Design</li> <li>• Jumper-less Design</li> <li>• Unibody Design</li> </ul>
<b>Reliability &amp; Protection</b>	
Reverse Power Input	• Yes
Over Voltage Protection	<ul style="list-style-type: none"> <li>• Protection Range: 51~58V</li> <li>• Protection Type: shut down operating voltage, re-power on at the preset level to recover</li> </ul>
Over Current Protection	• 15A
CMOS Battery Backup	• SuperCap Integrated for CMOS Battery Maintenance-free Operation
MTBF	• 614,831 Hours - Database: Telcordia SR-332 Issue3, Method 1, Case 3
<b>Operating System</b>	
Windows	• Windows® 11, Windows® 10
Linux	• Ubuntu 22.04
<b>Environment</b>	
Operating Temperature	<ul style="list-style-type: none"> <li>• -40°C to 70°C</li> <li>* PassMark BurnInTest: 100% CPU, 2D/3D Graphics (without thermal throttling)</li> <li>* With extended temperature peripherals; Ambient with air flow</li> <li>* According to IEC60068-2-1, IEC60068-2-2, IEC60068-2-14</li> </ul>
Storage Temperature	• -40°C to 70°C
Relative Humidity	• 95% RH @ 70°C (Non-condensing)
Shock	• MIL-STD-810H
Vibration	• MIL-STD-810H
EMC	<ul style="list-style-type: none"> <li>• CE, UKCA, FCC, ICES-003 Class A</li> <li>• EN61000-6-4, EN61000-6-2 (24VDC Input Only)</li> </ul>
EMI	<ul style="list-style-type: none"> <li>• CISPR 32 Conducted &amp; Radiated: Class A</li> <li>• EN/BS EN 55032 Conducted &amp; Radiated: Class A</li> <li>• EN/BS EN IEC 61000-3-2 Harmonic current emissions: Class A</li> <li>• EN/BS EN61000-3-3 Voltage fluctuations &amp; flicker</li> <li>• FCC 47 CFR Part 15B, ICES-003 Conducted &amp; Radiated: Class A</li> </ul>
EMS	<ul style="list-style-type: none"> <li>• EN/IEC 61000-4-2 ESD: Contact: 4 kV; Air: 8 kV</li> <li>• EN/IEC 61000-4-3 RS: 80 MHz to 1000 MHz: 10 V/m</li> <li>• EN/IEC 61000-4-4 EFT: AC Power: 2 kV; DC Power: 1 kV; Signal: 1 kV</li> <li>• EN/IEC 61000-4-5 Surges: AC Power: 2 kV; Signal: 1 kV</li> <li>• EN/IEC 61000-4-6 CS: 10V</li> <li>(**Compliant with the standard when utilizing shielded ethernet cable.)</li> <li>• EN/IEC 61000-4-8 PFMF: 50 Hz, 30A/m</li> <li>• EN/IEC 61000-4-11 Voltage Dips &amp; Voltage Interruptions: 1 cycles at 60 Hz</li> </ul>

**External Layout**

Front I/O

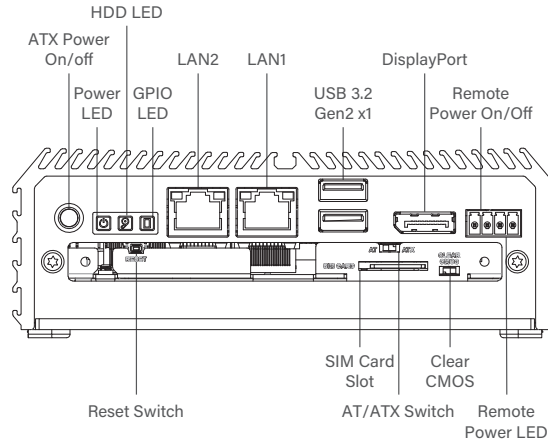

Rear I/O

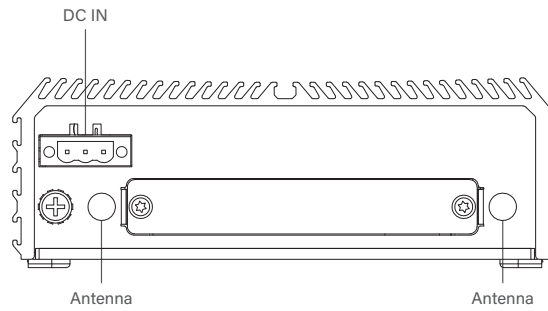

**Dimensions**

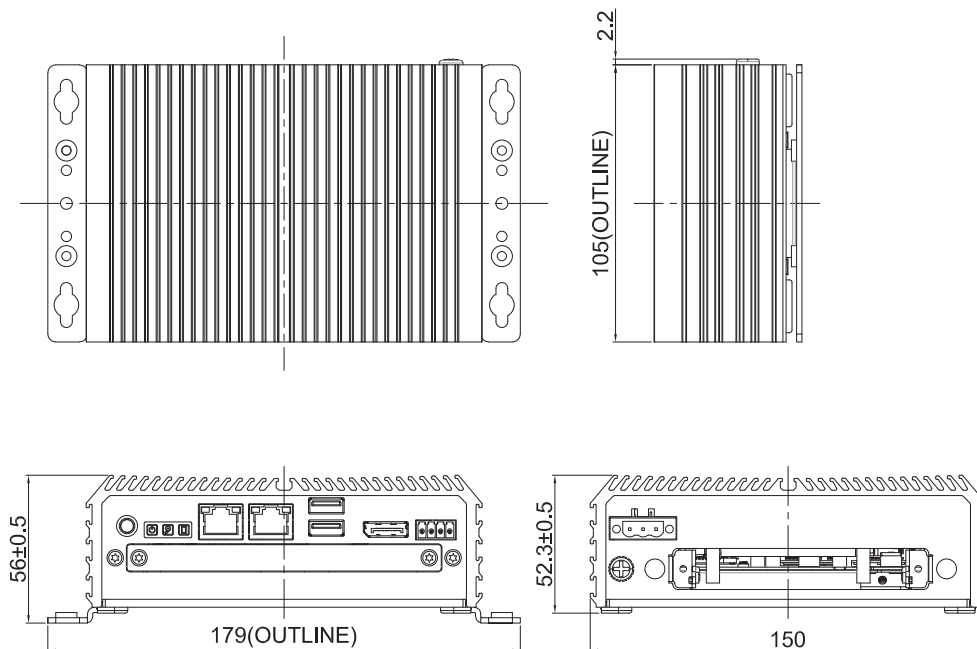

Unit: mm

## Ordering Information

### Available Models

Model No.	Description
DA-1200-N97-R10	Intel Alder Lake-N Processor N97 Rugged Embedded Computer

### Package Checklist

• DA-1200 Embedded System x1	• Wall Mounting Kit x1
• Thermal Pad (for CPU Thermal Block) x 1	• Power Terminal Block Connector x 1
• Screw Pack x 1	• Remote Function Terminal Block Connector x 1
• M.2 Key B Type 3052 to 3042 Adapter Bracket x1	

### Optional Modules and Accessories

Model No.	Description
CMI-DP101	CMI Module with 1x DP Connector
CMI-HD01	CMI Module with 1x HDMI Connector
CMI-DVI101	CMI Module with 1x DVI Connector
CMI-VGA101	CMI Module with 1x VGA Connector
CMI-LPPS102	CMI Module with 1x LPT Port, 1x PS/2 Connector
CMI-COM102	CMI Module with 2x RS232/422/485 Ports (Support 5V/12V)
CMI-DIO100	CMI Module with 16DIO (8in 8out)
UB0403	Universal Bracket with 2x DB9 Cutout for DA Series
UB0415	Universal Bracket with DIO Cutout for DA Series
UB0409	Universal Bracket with PS/2, LPT Cutout for DA Series
UB0406	Universal Bracket with DP Cutout for DA Series
UB0407	Universal Bracket with DVI-D Cutout for DA Series
UB0416	Universal Bracket with VGA Cutout for DA Series
UB0408	Universal Bracket with HDMI Cutout for DA Series
UB0429-R10	Universal Bracket with 2x Antenna Cutout
SIDE02	Side Mount Kit for DA Series, with KMRH-K175 for DIN-Rail option
DINRAIL-R10	Diamond series DIN-RAIL Mount Kit
AC-BE01-R10	M.2 Key B Type 2242 to M.2 Key E Type 2230 Adapter Card
GST60A12-CIN-1	Adapter AC/DC 12V 5A 60W, GST60A12-CIN1, wide temp(-30°C ~ +70°C)

**Optional Module Configuration**

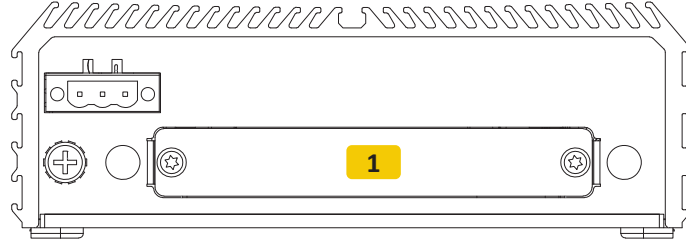

Model No.	Description	1
CMI-COM102/UB0403	CMI Module with 2x RS232/422/485 / 1x Universal Bracket with 2x DB9 Cutout for DA Series	V
CMI-DIO100/UB0415	CMI Module with 8x Optical Isolated DIO (4 in/4 out) / 1x Universal Bracket with DIO Cutout for DA Series	V
CMI-LPPS102/UB0409	CMI Module with 1x LPT Port, 1x PS/2 / 1x Universal Bracket with PS/2, LPT Cutout for DA Series	V
CMI-DP101/UB0406	CMI Module with 1x Display Port / 1x Universal Bracket with DP Cutout for DA Series	V
CMI-DVI101/UB0407	CMI Module with 1x DVI-D Connector / 1x Universal Bracket with DVI-D Cutout for DA Series	V
CMI-VGA101/UB0416	CMI Module with 1x VGA Port / 1x Universal Bracket with VGA Cutout for DA Series	V
CMI-HD01/UB0408	CMI Module with 1x HDMI Port / 1x Universal Bracket with HDMI Cutout for DA Series	V

V : Compatible

## Assured Systems

Assured Systems is a leading technology company with over 1,500 regular clients in 80 countries, deploying over 85,000 systems to a diverse customer base in 12 years of business. We offer high-quality and innovative rugged computing, display, networking and data collection solutions to the embedded, industrial, and digital-out-of-home market sectors.

### US

[sales@assured-systems.com](mailto:sales@assured-systems.com)

Sales: +1 347 719 4508  
Support: +1 347 719 4508

1309 Coffeen Ave  
Ste 1200  
Sheridan  
WY 82801  
USA

### EMEA

[sales@assured-systems.com](mailto:sales@assured-systems.com)

Sales: +44 (0)1785 879 050  
Support: +44 (0)1785 879 050

Unit A5 Douglas Park  
Stone Business Park  
Stone  
ST15 0YJ  
United Kingdom

VAT Number: 120 9546 28  
Business Registration Number: 07699660