

**Features:**

- Hyper Dimming : Dimming knob control backlight brightness from nearly 0% to 100%
- Sunlight Readable : Transflective film technology enhance visibility
- Anti-Corrosion & IP Proof : IP65 aluminum housing with powder coating design (IP54 rear)
- Wide Voltage Range Input : 24 V DC to DC power input acceptable (Isolation Resistance)
- Touchscreen/ Protection Glass : High quality touchscreen / AR protection glass for option
- Multiscan Function : PIP(picture in picture) function and multi-video inputs
- IP65 OSD Front Panel Design : Ease of use front panel OSD control
- Anti-Shock and Vibration : Enhanced shock and vibration resistance

**Mechanical Design Drawing**

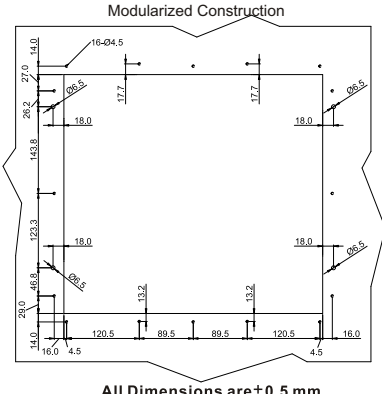
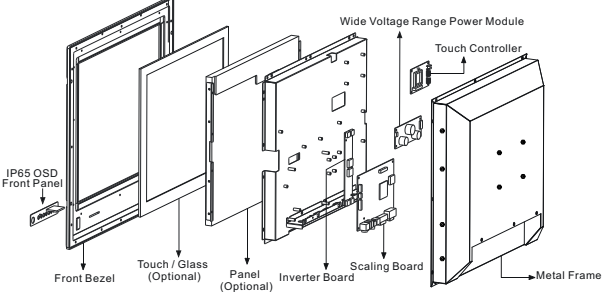
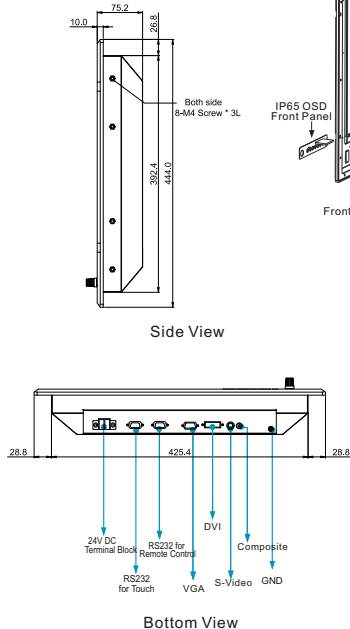
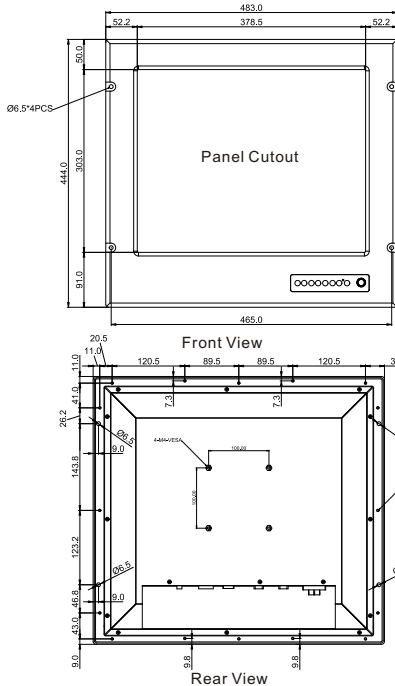

All Dimensions are ±0.5 mm

\* Note: this is a simplified drawing and some components are not marked in detail. Please contact our sales representative if you need further product information.

**TFT Characteristics:**

Pixel Number	: 1280 x 1024
Pixel Pitch(RGB)	: 0.294 (H) x 0.294 (V) mm
Contrast Ratio	: 1000:1(typ.)
Light Intensity	: 400 cd/m <sup>2</sup> (typ.)
Viewable Angles	: -85~85(H);-80~80(V)
Active Display Area	: 376.32 (H) x 301.06(V) mm
Max Colors	: 16.7M (8bit/colors)

**Input Signals:**

RGB Signal	: D-SUB 15P connector(female)
Composite Video	: RCA phono plug
S-Video Signal	: S-Video (SVHS) plug
DVI-D Signal	: DVI-D input 24pin connector
DC Power Signal	: Screw terminal block
AC Power Signal (Optional)	: Std IEC Inlet
Touch Screen (Optional)	: D-SUB 9P connector (female)
Remote via RS-232 (Optional)	: D-SUB 9P connector (female)

**User Controls:**

Power On/Off via front button
VR Brightness Knob Control
Power Mode Status LED
On Screen Display control(OSD)
OSD Remote Control via RS-232

**Power Specifications:**

Power Supply Options	: 24 V DC power supply with Terminal block (Default, Isolation Resistance),90 to 265V AC power supply
Power Consumption	: 45 W typical, normal operation

**Mechanical and Environmental:**

Mechanical Mounting	: Panel (Flush) mount with IP65*, VESA, Bracket mounting
Operating Temperature	: -10 to 55 deg.C (-20 to 60 deg.C for optional heating)
Operating Humidity	: 5% to 95% (non condensing)
Anti-Vibration	: 5Hz~500Hz / 1Grms/3 Axis
Anti-Shock	: 15G, 11ms duration
* SAW touch for IP54	

**Available Options:**

Touch Screen Options	: SAW, 5 Wire Resistive
AR Safety Glass Options	: 3mm Anti-reflective protection glass
Transflective Options	: Yes (Enhance Visibility)
AC power Options	: Yes (90 to 265 V AC power input)
Bracket Mounting Options	: Yes (One robust bracket can adjust from -10 to 30 deg.)

**Certification and Approvals** : IEC 60945, DVN 2.4, IACS-E10  
DNV Type Approval, CE, FCC

Note: All Specifications are subject to change without prior notice!



Revised Date : 02/16/2011



# 19" Marine Bridge System Display

Model # R19L300-MRA1

**Mechanical Design with Robust Bracket (options)**

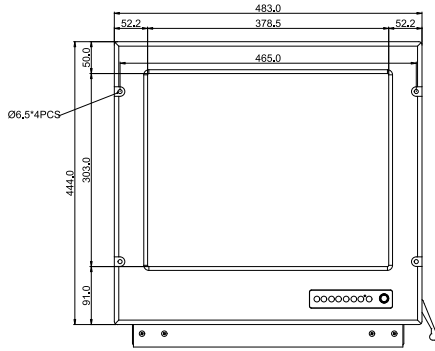

FRONT VIEW

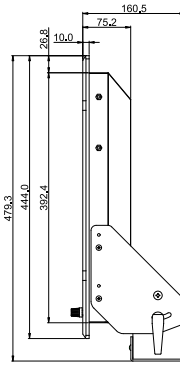

SIDE VIEW

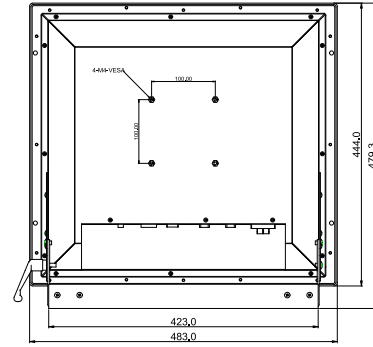

BACK VIEW

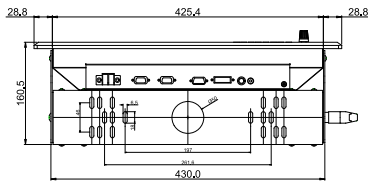

BOTTOM VIEW

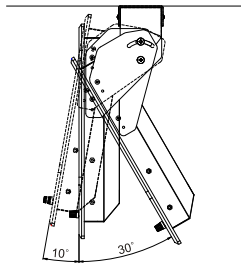

ROOF MOUNT

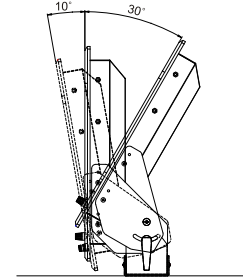

STAND ANGLE

**ROOF MOUNT**

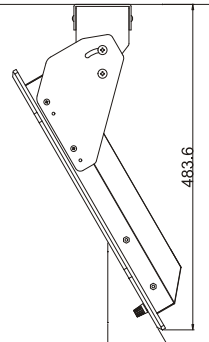
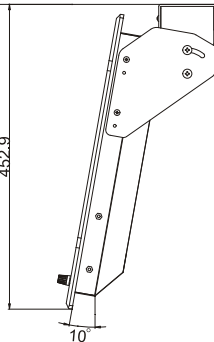
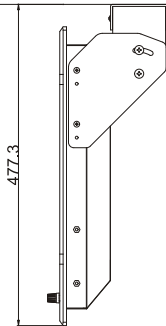

**STAND ANGLE**

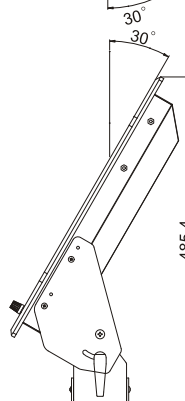
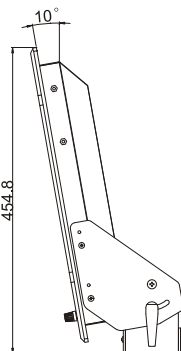
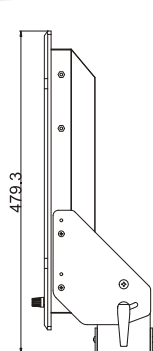

All Dimensions are  $\pm 0.5$  mm

\*Note: this is a simplified drawing and some components are not marked in detail. Please contact our sales representative if you need further product information.

Rev.	Reasons	Revised Date
1.0	Add holes for brackets on back cover*	Nov-17-08
1.1	Spec change	Oct-08-09
1.2	Spec change	Feb-16-11

\*Extra charge is required for back covers with bracket holes for products purchased before end of Nov. 08'

**Certification and Approvals : IEC 60945, DVN 2.4, IACS-E10  
DNV Type Approval, CE, FCC**

Note: All Specifications are subject to change without prior notice!

Revised Date : 02/16/2011

## Assured Systems

Assured Systems is a leading technology company with over 1,500 regular clients in 80 countries, deploying over 85,000 systems to a diverse customer base in 12 years of business. We offer high-quality and innovative rugged computing, display, networking and data collection solutions to the embedded, industrial, and digital-out-of-home market sectors.

### US

[sales@assured-systems.com](mailto:sales@assured-systems.com)

Sales: +1 347 719 4508  
Support: +1 347 719 4508

1309 Coffeen Ave  
Ste 1200  
Sheridan  
WY 82801  
USA

### EMEA

[sales@assured-systems.com](mailto:sales@assured-systems.com)

Sales: +44 (0)1785 879 050  
Support: +44 (0)1785 879 050

Unit A5 Douglas Park  
Stone Business Park  
Stone  
ST15 0YJ  
United Kingdom

VAT Number: 120 9546 28  
Business Registration Number: 07699660