



19" Marine Monitors
DuraVision[®]
FDS1904 / FDS1904T



FDS1904



FDS1904T

Panel Mount Marine Monitors with LED Backlight for ECDIS / RADAR Applications

Durable and Reliable

The FDS1904 and FDS1904T offer durability for use in harsh maritime environments, complying with the conditions for temperature, humidity, and vibration as defined in the IEC 60945 international standard for maritime navigation and radio communication equipment and systems. IP65 rating ensures they can withstand dust ingress and are protected against low-pressure water jets. A coating is applied to make the electronic substrates moisture-proof and the cooling fan is easily accessible for exchanging purposes.

Approval from Classification Societies

The monitors meet the requirements for major maritime classifications. They come standard with approvals for LR (UK), DNV (Norway), ABS (USA), and ClassNK (Japan). Additional certifications for GL (Germany), BV (France), KR (Korea), and CCS (China) are available on request.

Long-Lasting LED Backlight

The monitors are equipped with an LED backlight. Compared to conventional CCFL backlights, LED backlights last longer and consume less power. They are also mercury-free for minimal impact on the environment.

Calibrated for ECDIS

Backlight brightness, gamma, and RGB color settings are calibrated at the factory so each monitor achieves accurate color reproduction for meeting the highly specialized requirements of ECDIS systems. Both monitors meet IEC 61174, IEC 62288, and IEC 62388 international standards for ECDIS and RADAR applications.

Wide Dimming Range

The wide dimming range of less than 1 cd/m² up to 590 cd/m² (540 cd/m² for the FDS1904T) allows you to adjust to the appropriate brightness level for viewing during the day or at night.

Clear View

The VA panel features wide viewing angles that minimize changes in contrast and gradation to maintain excellent visibility when the screen is viewed from the side. An AR coating is applied to reduce the amount of reflections on the screen for a clear display.

Touch Panel Model

The FDS1904T features a projected capacitive touch panel that accepts touch input from a bare hand or special stylus and supports multi-touch operation. It is also highly resistant to dust and water droplets to minimize unintended input.

Optical Bonding for High Visibility

Optional optical bonding is available for both models. Optical bonding significantly reduces reflective light for high visibility even when the screen is viewed in direct sunlight. A screen with optical bonding is also more resistant to applied pressure, giving it increased physical durability.

Additional Features

- 24-Hour Use, 3-Year Warranty
- ECDIS Indicator
- Marine Alarm Buzzer

Dimensions (mm)

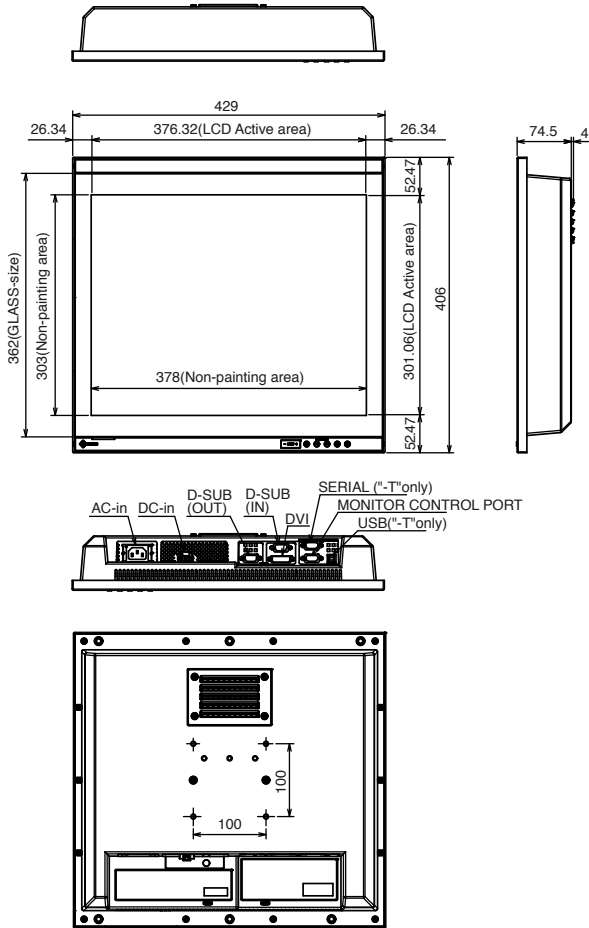

Panel aperture dimensions

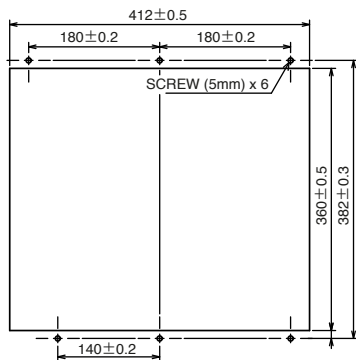

SPECIFICATIONS

Models	FDS1904	FDS1904T
Cabinet Color	Black	
Panel Type	VA	
Backlight	LED	
Panel Size	19" / 48 cm (481 mm diagonal)	
Native Resolution	1280 x 1024	
Display Size (H x V)	376.3 x 301 mm	
Pixel Pitch	0.294 x 0.294 mm	
Display Colors	16.7 million	
Viewing Angles (H / V, typical)	178°, 178°	
Maximum Brightness	590 cd/m ²	540 cd/m ²
Contrast Ratio (typical)	2000:1	
Response Time (typical)	20 ms (black-white-black)	
Input Terminals	Video	DVI-D 24 pin x 1, D-Sub mini 15 pin x 1
	Monitor Control	D-Sub mini 9 pin (female) x 1
	Touch Panel Control	-
		D-sub 9 pin (male) x 1 USB upstream
Digital Scanning Frequency (H / V)	31 - 64 kHz, 59 - 61 Hz (VGA Text: 69 - 71 Hz)	
Analog Scanning Frequency (H / V)	31 - 80 kHz, 56 - 76 Hz	
Power supply	AC: Rating AC 100 - 240V (Operating: AC 85 - 264V), 50 / 60Hz, 0.65A (AC100V) / 0.3A (AC200V) DC: Rating DC+24V (Operating: +30% / -10%), 2.7A (DC24V)	
Maximum Power Consumption (AC / DC)	64 W	
Power Management	Power Save (VESA DPM and DVI DMPM), Eco Timer	
Preset Modes	Color Mode (Custom, Day, Dusk, Night)	
OSD Languages	English	
Others	Screen Size, Color Adjustment (Brightness, Temperature, Gamma, Hue, Brilliance, Outline Enhancer, Gain, Reset), Power Save, Power Indicator, Eco Timer, Input, Input Selection, Auto Sharpness, Signal Info, Monitor Info, All Reset, Key Lock, DDG/CI, Backlight Off Mode, Orientation, ECDIS Indicator	
Dimensions	429 x 406 x 75 mm	
Net Weight	5.9 kg	6.4 kg
Operating Temperature / Humidity	-15 - 55 °C / 10 - 90 % (R.H., non condensing)	
Degree of Protection	IP65 (Rear: IP22)	
Compass Safe Distance	Standard compass: 0.95 m Steering compass: 0.6 m	
Certifications & Standards	Ship Classification: LR (UK), NK (Japan), ABS (USA), DNV (Norway) General: CB, CE, RoHS, WEEE, China RoHS, IEC60945, IEC62288, IEC61174, IEC62388, KC (K60950-1, K0022, K0024)	
Supplied Accessories	Setup manual, Utility disk, AR cloth	
Warranty	3 years	

Touch Panel

Touch Panel Type	-	Projected Capacitive
Communication Protocol	-	USB
Compatible OS	-	Windows 8.1 (64-bit / 32-bit) / Windows 8 (64-bit / 32-bit) / Windows 7 (64-bit / 32-bit) / Windows Vista (64-bit / 32-bit) / Windows XP (32-bit)
Multi Touch Capability	-	Maximum 5 point

Please visit the product pages on eizo.com for information on ship classification.

EIZO Corporation

153 Shimokashiwano, Hakusan, Ishikawa 924-8566 Japan
Phone +81-76-277-6792 Fax +81-76-277-6793
www.eizo.com

All product names are trademarks or registered trademarks of their respective companies. DuraVision and EIZO are registered trademarks of EIZO Corporation. Specifications are subject to change without notice.

Copyright©2014 EIZO Corporation. All rights reserved.

Assured Systems

Assured Systems is a leading technology company with over 1,500 regular clients in 80 countries, deploying over 85,000 systems to a diverse customer base in 12 years of business. We offer high-quality and innovative rugged computing, display, networking and data collection solutions to the embedded, industrial, and digital-out-of-home market sectors.

US

sales@assured-systems.com

Sales: +1 347 719 4508
Support: +1 347 719 4508

1309 Coffeen Ave
Ste 1200
Sheridan
WY 82801
USA

EMEA

sales@assured-systems.com

Sales: +44 (0)1785 879 050
Support: +44 (0)1785 879 050

Unit A5 Douglas Park
Stone Business Park
Stone
ST15 0YJ
United Kingdom

VAT Number: 120 9546 28
Business Registration Number: 07699660