

86" 4K Large Format Display

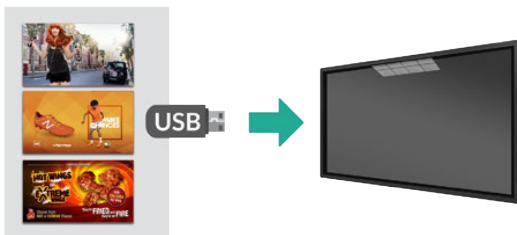

Plug and Play

Plug and Play is the most straightforward way to upload content to the screen. Simply load images and videos on a USB stick, insert in the display, wait for your content to copy over and then remove. Your images and videos will now play in a continuous loop.



24/7 Commercial Use

These displays use a commercial grade LCD panel and LED backlight. They have the ability to be in constant use 24/7 for over 70,000 hours and have no external buttons or controls to avoid tampering.



Integrated Android Media Player

There is an integrated Android media player inside the screen allowing you to upgrade to a network version without needing any additional hardware. You can also install third party Android apps if required.



Remarkable 4K Display

With four times the resolution of Full HD, get amazing picture quality for a truly immersive viewing experience when using HDMI.

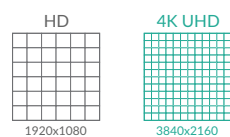

Other Features

450cd/m² Commercial Panel

A commercial grade panel and compents are used to ensure reliable 24/7 use in public spaces. The screen can also be used in landscape or portrait orientation.

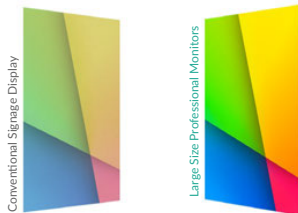

Stunning Enclosure

The precision frame is crafted from black aluminium and assembled in segments so the enclosure can remain sexy and sleek with rounded corners and a tempered glass front for protection. A polymer rear cover keeps the display slim and lightweight.



Low Power Consumption

The LED backlight technology provides improved brightness and contrast. Their lifespan is drastically improved to over 70,000 hours and the power consumption is reduced by around 30%.

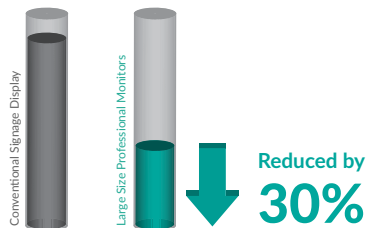

Power Timer

The eco-friendly power timer allows you to assign daily or weekly on and off times for your screen meaning that it is only in use when it needs to be; improving your environmental efficiency.



Temperature Control

A fanless cooling system keeps their panels and other internal components at the optimum working temperature; ensuring a long and reliable life for your screen.

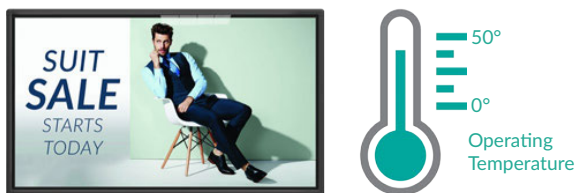

RS-232 Control

Remotely control your screens by sending commands over long or short distances using RS-232 protocols, ideal for CCTV control rooms.

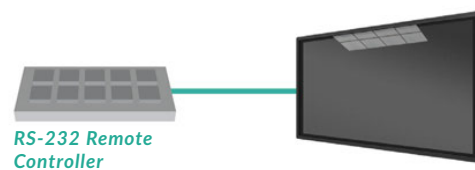

Multiple Inputs

Should you need to use the screen as a monitor you can connect it to an external source, like a PC or media player, using the HDMI input or the VGA and 5mm audio jack inputs.

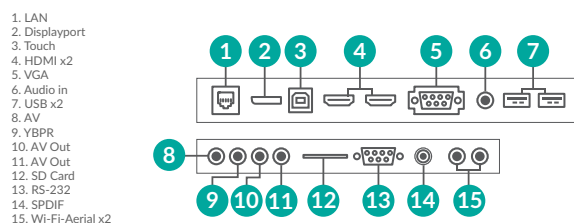

Optional Network Upgrade

For a small charge you can upgrade your screen to be networked, allowing you to connect your screen via Wi-Fi, LAN or 4G, then remotely update it over the internet.



Key Features



PLUG AND PLAY



INTEGRATED ANDROID
MEDIA PLAYER



24/7 COMMERCIAL GRADE



ECO POWER TIMER



LANDSCAPE OR PORTRAIT
ORIENTATION



CONNECT DEVICES



LED BACKLIGHT



STUNNING ENCLOSURE

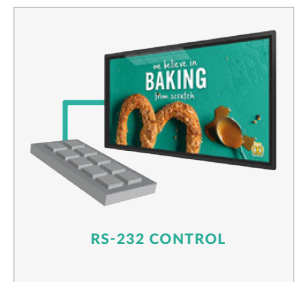
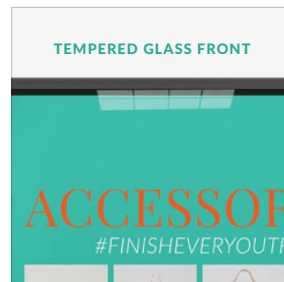
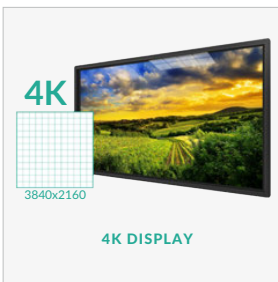

Specification Table

		86 Inch
Panel	Resolution	3840x2160
	Display Area (mm)	1895x1066
	Aspect Ratio	16:9
	Brightness (cd/m ²)	450
	Colour	16.7M
	Viewing Angle	178°
	Contrast Ratio	4000:1
Audio	Speaker Type	5W, 8Ω (x2)
AV Inputs	Inputs	DisplayPort, HDMI x 2, VGA, Audio In, USB 3.0 x 2, AV In, YPbPr, SD Card
	Outputs	AV Out, Audio Out, SPDIF
	Control	RS-232
Power	Power Consumption (W)	420
	Input Voltage	AC110-240V(50Hz-60Hz)
Mechanical	Unit Size (WxHxD mm)	2018.4x1189.5x117.9
	Package Size (WxHxD mm)	2330x1710x530
	VESA Holes (mm)	600x400
	Net Weight (kg)	81.8
	Gross Weight (kg)	190
Environmental	Operating Temperature	0 °C to 50 °C
	Storage Temperature	-30°C to 60°C
	Operating Humidity	10% to 80%
	Storage Humidity	5% to 95%
Computer	Media Formats	Video (MPG, AVI, MP4, RM, RMVB, TS), Audio (MP3, WMA), Image (JPG, GIF, BMP, PNG)
	Media Resolution	1920x1080/1080x1920
	CPU	ARM Quad-core Cortex-A53 1.4GHz
	RAM	2GB DDR3
	Architecture	64-bit
	Graphic Engine	Mali450MP4 (6-core) 450MHz
	Hard Drive/Internal Memory (eMMC)	16GB
	USB	USB 3.0 x 2, USB 2.0 x 3
	LAN	10/100 Ethernet
	Wi-Fi	802.11b/g/n/ac
	OS	Android 5.0.1
Accessories	Included	Remote Control, User Manual, Power Lead
	Optional	Network Upgrade
Warranty	Warranty Period	3 Year Warranty
	Technical Support	Lifetime

Errors and omissions excepted



Technical Drawing

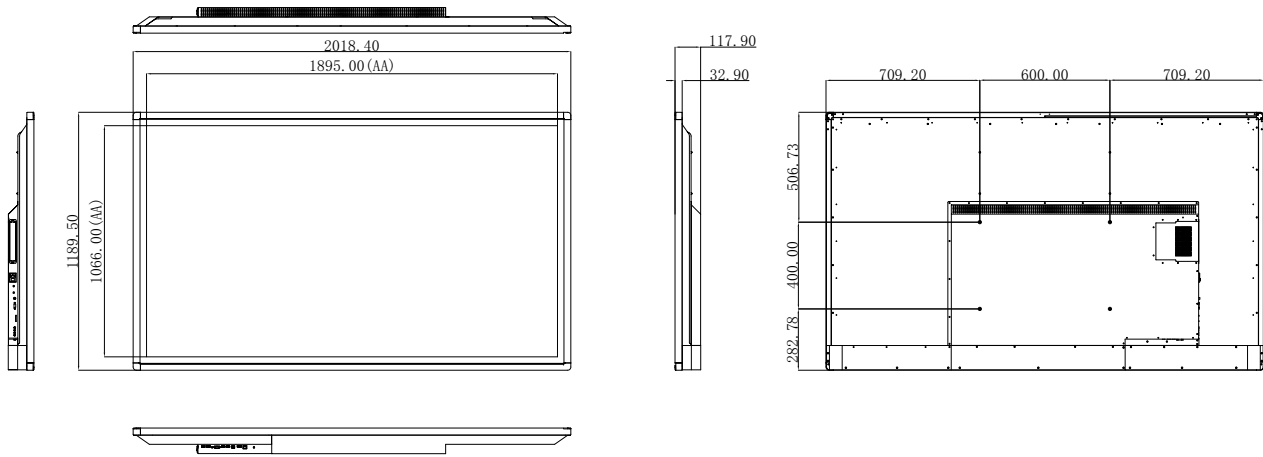

Assured Systems

Assured Systems is a leading technology company with over 1,500 regular clients in 80 countries, deploying over 85,000 systems to a diverse customer base in 12 years of business. We offer high-quality and innovative rugged computing, display, networking and data collection solutions to the embedded, industrial, and digital-out-of-home market sectors.

US

sales@assured-systems.com

Sales: +1 347 719 4508
Support: +1 347 719 4508

1309 Coffeen Ave
Ste 1200
Sheridan
WY 82801
USA

EMEA

sales@assured-systems.com

Sales: +44 (0)1785 879 050
Support: +44 (0)1785 879 050

Unit A5 Douglas Park
Stone Business Park
Stone
ST15 0YJ
United Kingdom

VAT Number: 120 9546 28
Business Registration Number: 07699660