

# SFP-10G-WA40

10G Fiber SFP+ Transceiver WDM-A, Single Mode 40Km / LC/ Tx:1270nm Rx: 1330nm, 0°C~70°C  
(Cisco Compatible)

## Features



- ▶ 11.1Gbps Data Links
- ▶ Up to 40km Transmission on SMF
- ▶ Single Mode Fiber Tx:1270 Rx:1330
- ▶ 2-Wire Interface with Integrated Digital Diagnostic Monitoring
- ▶ EEPROM with Serial ID Functionality
- ▶ Hot-Swappable SFP+ Design
- ▶ Compliant with SFP+ Multi-Source Agreement
- ▶ Single LC Connector
- ▶ Single +3.3V Supplied Power
- ▶ RoHS Compliant
- ▶ SFP-8472 Compliant
- ▶ SFP-8431 Compliant
- ▶ RoHS Compliant
- ▶ Operating Temperature Range: -0° to 70° C
- ▶ 5-Year Warranty

## ▶ Dimensions (unit = mm)

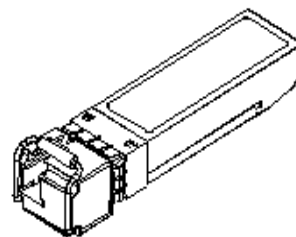
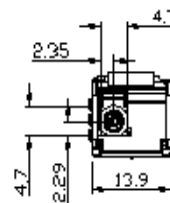
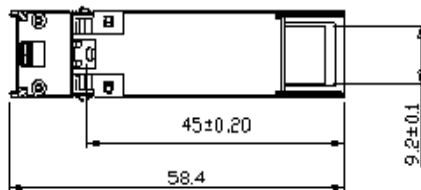
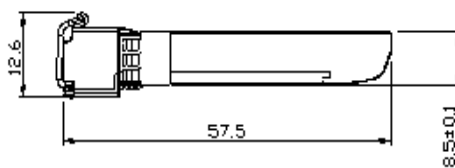
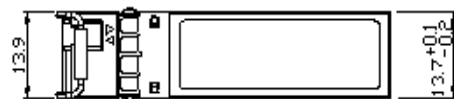

## ► Specifications

### Technology

|               |              |
|---------------|--------------|
| Standards     | IEEE 802.3ae |
| Transfer Rate | 10.3125Gbps  |

### Max Ratings

|                      |                         |
|----------------------|-------------------------|
| Storage Temperature  | -40~85° C               |
| Humidity             | 5~95% non-condescending |
| Power Supply Voltage | 0.3 ~ 4 Volts Max       |
| Signal Input Voltage | Vcc -0.3 ~ +0.3         |

### Recommended Operating Conditions

|                       |                               |
|-----------------------|-------------------------------|
| Operating Temperature | -5 ~ 70°C                     |
| Power Supply Voltage  | 3.3 Volts                     |
| Power Supply Current  | 450mA                         |
| Data Rate             | 10.3125 Gbps                  |
| Transmission Distance | 40km                          |
| Fiber Type            | Single Mode Fiber 9/125um SMF |

### Optical Characteristics Tx

|                               |                                      |
|-------------------------------|--------------------------------------|
| Average Launch Power          | 0 ~ 5 dBm                            |
| Center Wavelength Range       | 1260-1270-1280nm<br>1320-1330-1340nm |
| Single Mode Suppression Ratio | 30dB                                 |
| Spectrum Bandwidth (-20dB)    | 1nm                                  |
| Extinction Ratio              | 3.5                                  |

### Optical Characteristics Rx

|                           |                                      |
|---------------------------|--------------------------------------|
| Center Wavelength Range   | 1320-1330-1340nm<br>1260-1270-1280nm |
| Receiver Sensitivity      | -14.4dBm                             |
| Saturation Power Overload | 0.5dBm                               |
| Assert Power              | -30dBm                               |
| Deassert                  | -14dBm                               |
| Hysteresis                | 0.5 ~ 5 dB                           |

### Electrical Interface Characteristics Tx

|                                   |                  |
|-----------------------------------|------------------|
| Power Supply Current              | 450mA            |
| Differential Data Input Voltage   | 180 ~ 700 m Vp-p |
| Differential Line Input Impedance | 100 Ohm          |
| Transmitter Fault Output High     | 2.4V             |
| Transmitter Fault Output Low      | -0.3 ~0.8 V      |

### Electrical Interface Characteristics Rx

|                                   |                  |
|-----------------------------------|------------------|
| Differential Data Input Voltage   | 300 ~ 850 m Vp-p |
| Differential Line Input Impedance | 100 Ohm          |
| Receiver LOS Pull Up Resistor     | 4.7 ~ 10 KOhm    |
| Data Output Rise/Fall Time        | 38               |
| LOS Output Voltage-High           | 2V               |
| LOS Output Voltage-Low            | -0.3 ~ 0.4 V     |

**► Pin Assignment**

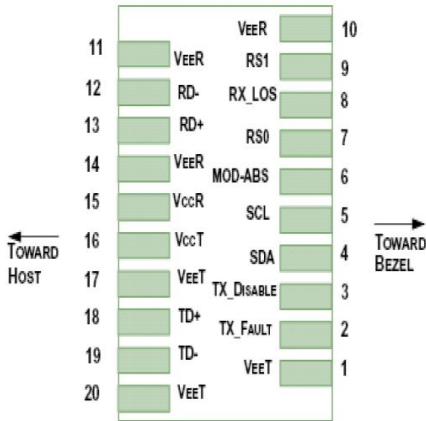

| Pin | Symbol  | Name/Description   | NOTE |
|-----|---------|--|------|
| 1   | VEET    | Transmitter Ground (Common with Receiver Ground)               | 1    |
| 2   | T_FAULT | Transmitter Fault.   | 2    |
| 3   | T_DIS   | Transmitter Disable. Laser output disabled on high or open.    | 3    |
| 4   | SDA     | 2-wire Serial Interface Data Line                              | 4    |
| 5   | SCL     | 2-wire Serial Interface Clock Line                             | 4    |
| 6   | MOD_ABS | Module Absent. Grounded within the module                      | 4    |
| 7   | RS0     | Rate Select 0  | 5    |
| 8   | LOS     | Loss of Signal indication. Logic 0 indicates normal operation. | 6    |
| 9   | RS1     | No connection required   | 1    |
| 10  | VEER    | Receiver Ground (Common with Transmitter Ground)               | 1    |
| 11  | VEER    | Receiver Ground (Common with Transmitter Ground)               | 1    |
| 12  | RD-     | Receiver Inverted DATA out. AC Coupled                         |      |
| 13  | RD+     | Receiver Non-inverted DATA out. AC Coupled                     |      |
| 14  | VEER    | Receiver Ground (Common with Transmitter Ground)               | 1    |
| 15  | VCCR    | Receiver Power Supply  |      |
| 16  | VCC     | Transmitter Power Supply                                       |      |
| 17  | VEET    | Transmitter Ground (Common with Receiver Ground)               | 1    |
| 18  | TD+     | Transmitter Non-Inverted DATA in. AC Coupled.                  |      |
| 19  | TD-     | Transmitter Inverted DATA in. AC Coupled.                      |      |
| 20  | VEET    | Transmitter Ground (Common with Receiver Ground)               | 1    |

**► Interface Circuit**

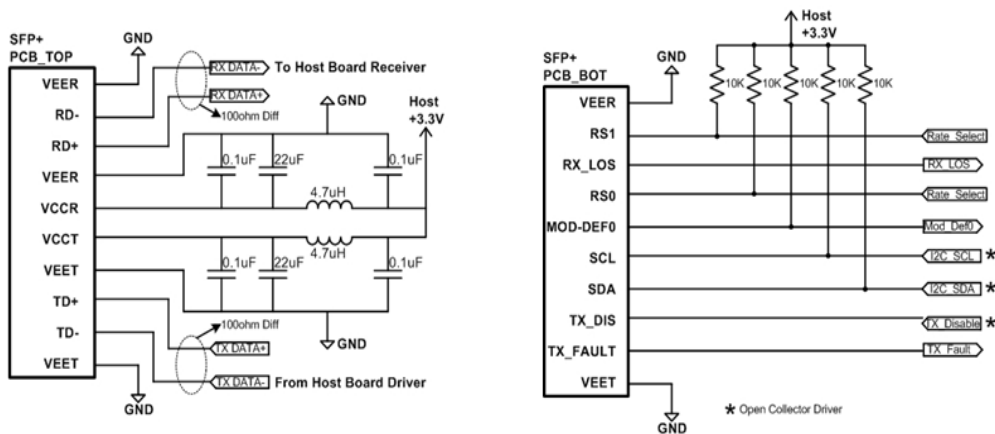

▶ **Regulatory Approvals**

| Feature                            | Reference  | Performance               |
|------------------------------------|--|---------------------------|
| Electrostatic discharge (ESD)      | IEC/EN 61000-4-2                                 | Compatible with standards |
| Electromagnetic Interference (EMI) | FCC Part 15 Class B EN 55022 Class B (CISPR 22A) | Compatible with standards |
| Laser Eye Safety                   | FDA 21CFR 1040.10, 1040.11 IEC/EN 60825-1, 2     | Class 1 laser product     |
| Component Recognition              | IEC/EN 60950 , UL                                | Compatible with standards |
| ROHS                               | 2002/95/EC                                       | Compatible with standards |
| EMC                                | EN61000-3  | Compatible with standards |

▶ **Ordering Information**

- SFP-10G-WA40**      10G Fiber SFP+ Transceiver WDM-A, Single Mode 40Km / LC/ Tx:1270nm Rx: 1330nm, 0°C~70°C (Cisco Compatible)
- SFP-10G-WB40**      10G Fiber SFP+ Transceiver WDM-B, Single Mode 40Km / LC/ Tx:1330nm Rx: 1270nm, 0°C~70°C (Cisco Compatible)

**Optional Accessories**

- CBF-LC01LC-SS**      LC to LC 1 Meter Single-Mode Simplex Fiber Cable

## Assured Systems

Assured Systems is a leading technology company with over 1,500 regular clients in 80 countries, deploying over 85,000 systems to a diverse customer base in 12 years of business. We offer high-quality and innovative rugged computing, display, networking and data collection solutions to the embedded, industrial, and digital-out-of-home market sectors.

### US

[sales@assured-systems.com](mailto:sales@assured-systems.com)

Sales: +1 347 719 4508  
Support: +1 347 719 4508

1309 Coffeen Ave  
Ste 1200  
Sheridan  
WY 82801  
USA

### EMEA

[sales@assured-systems.com](mailto:sales@assured-systems.com)

Sales: +44 (0)1785 879 050  
Support: +44 (0)1785 879 050

Unit A5 Douglas Park  
Stone Business Park  
Stone  
ST15 0YJ  
United Kingdom

VAT Number: 120 9546 28  
Business Registration Number: 07699660