

# EC500-ADS

H610E  
Q670E  
R680E



12th Gen Intel® Core™  
Modular-Designed Embedded System



## KEY FEATURES



### DDR4

DDR4 SODIMM up to 64GB



### Wide-Temperature

Operating temperature: -20 to 70°C



### Three Independent Displays

1 VGA + 2 HDMI/DP++ (auto detection)



### Multiple Expansion

3 M.2 slots (1 M.2 2230 E key, 1 M.2 3042/3052 B key, 1 M.2 2280 M key)



### Rich I/O

2 GbE, 6 COM, 4 USB 3.1, 2 USB 2.0



### Support 5G Communication

Support 5G communication



## PANEL

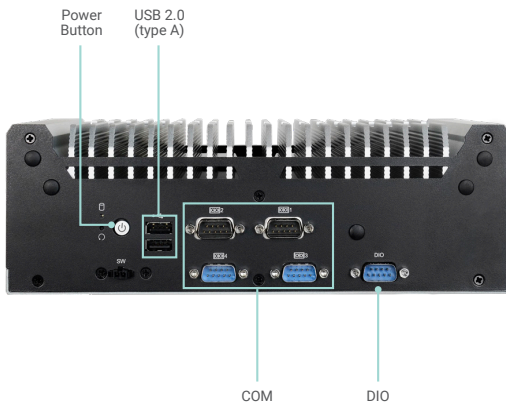

Front View

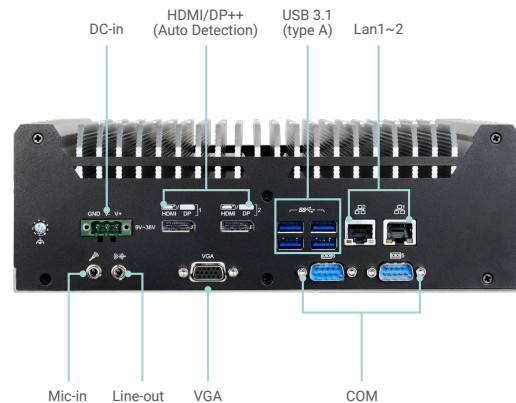

Rear View

**DIMENSIONS**

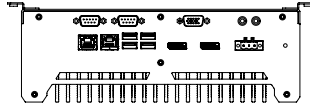

**Rear View**

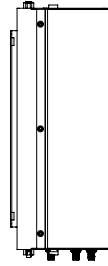

**Left View**

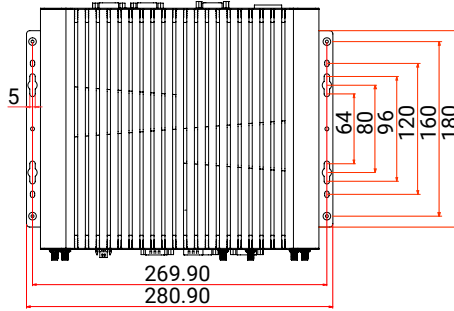

**Top View**

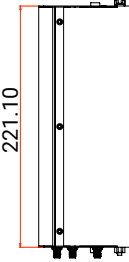

**Right View**

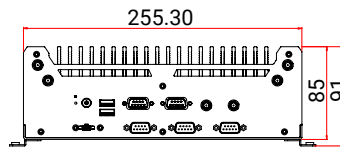

**Front View**

**WALL MOUNTING**

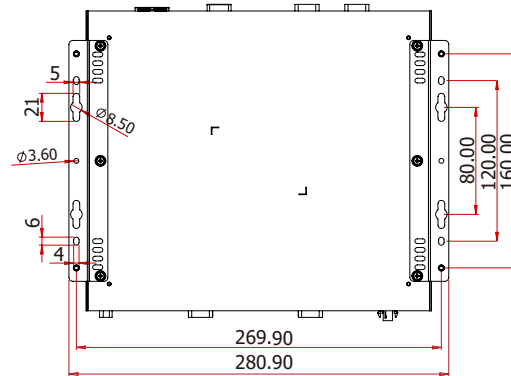
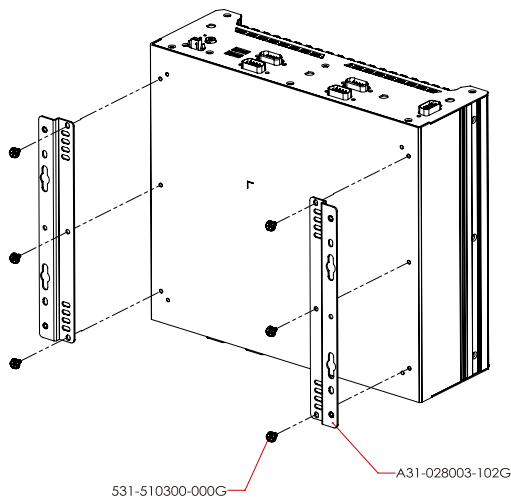

## SPECIFICATION

SYSTEM	Processor	12th Generation Intel® Core™ Processors, LGA 1700 Intel® Core™ i9-12900TE (16 Cores, 30M Cache, up to 4.8GHz); 35W Intel® Core™ i7-12700TE (12 Cores, 25M Cache, up to 4.6GHz); 35W Intel® Core™ i5-12500TE (6 Cores, 18M Cache, up to 4.3GHz); 35W Intel® Core™ i3-12100TE (4 Cores, 12M Cache, to 4GHz); 35W Intel® Pentium® G7400TE (2 Cores, 6M Cache, 3GHz); 35W Intel® Celeron® G6900TE (2 Cores, 4M Cache, 2.4GHz); 35W	
	Chipset	Intel® H610E/Q670E/R680E Chipset	
	Memory	Two 260-pin DDR4 3200MHz SODIMM up to 64GB	
	BIOS	AMI SPI 128Mbit	
GRAPHICS	Controller	Intel® HD Graphics	
	Feature	OpenGL up to 5.0, DirectX 11, OpenCL 2.1 HW Decode: HEVC/H.265, H.264, M/JPEG, MPEG2, VC1/WMV9, VP8 (8-bit), VP9 (10-bit) HW Encode: HEVC/H.265, M/JPEG, MPEG2, VP8	
	Display	1 x VGA 2 x HDMI/DP++ (auto detection)	VGA: resolution up to 1920x1200 @ 60Hz HDMI: resolution up to 4096x2160 @ 30Hz DP++: resolution up to 4096x2304 @ 60Hz
STORAGE	Internal	2 x 2.5" SATA 3.0 Drive Bay support RAID 0/1 (Q670E/R680E)	
EXPANSION	Interface	Q670E/R680E: 1 x M.2 2230 E key (PCIe/USB 2.0) 1 x M.2 2280 M key (PCIe x4 NVMe/SATA) 1 x M.2 3042/3052 B key (PCIe/USB3.0) H610E: 1 x M.2 2230 E key (PCIe/USB 2.0) 1 x M.2 3042/3052 B key (PCIe)	
		Audio Codec	Realtek ALC888
ETHERNET	Controller	2 x Intel® I225IT PCIe (10/100/1000Mbps)	
LED	Indicators	1 x Status LED 1 x HDD LED	
FRONT I/O	Serial	4 x RS-232/422/485 (DB-9)	
	USB	2 x USB 2.0 (type A)	
	DIO	8 bit (DB-9)	
	Buttons	1 x Power button 1 x Reset button	
REAR I/O	Antenna	4 x Antenna hole	
	Ethernet	2 x GbE (RJ-45)	
	Serial	2 x RS-232 (DB-9)	
	USB	4 x USB 3.1 (type A)	
	Display	VGA + 2 x HDMI/DP++ (auto detection)	
WATCHDOG TIMER	Audio	1 x Line-out 1 x Mic-in	
	Output & Interval	System reset, programmable via software from 1 to 255 seconds	
SECURITY	TPM	TPM 2.0	
POWER	Type	Wide range 9~36V	
	Connector	3-pole terminal nlock 3-pin power extension switch connector	
OS SUPPORT	Window	Windows 10 IoT Enterprise 2021 LTSC	
	Linux	Linux (available upon request)	
MECHANISM	Construction	Metal + Aluminum	
	Mounting	Wall Mount	
	Dimensions (W x H x D)	255.3 x 85 x 224mm	
	Weight	4.15 kg	
ENVIRONMENT	Operating Temperature	-20 to 70°C (SSD or M.2 storage)	
	Storage Temperature	-20 to 85°C	
	Relative Humidity	5 to 95% RH (non-condensing)	
STANDARDS AND CERTIFICATIONS	Shock	Half sine wave 3G, 11ms, 3 shock per axis	
	Vibration	IEC68-2-64	
	Certification	CE, FCC Class A, RoHS, UKCA, BIS	

## ORDERING INFORMATION

Model Name	Part Number	Description
EC500-ADS6861-H	750-EC5005-000G	EC500-ADS6861-H, Fanless, ADS263, H610E, i5-12500TE, 6 COM, 8 DIO, 6 USB, 1 VGA, 2 HDMI/DP, 2 LAN, 1 Line-out, 1 Mic-in, DC9~36V, TPM2.0, F/G SYSTEM RoHS
EC500-ADS6861-Q	750-EC5005-100G	EC500-ADS6861-Q, Fanless, ADS263, Q670E, i5-12500TE, 6 COM, 8 DIO, 6 USB, 1 VGA, 2 HDMI/DP, 2 LAN, 1 Line-out, 1 Mic-in, DC9~36V, TPM2.0, F/G SYSTEM RoHS
EC500-ADS6861-R	750-EC5005-200G	EC500-ADS6861-R, Fanless, ADS263, R680E, i5-12500TE, 6 COM, 8 DIO, 6 USB, 1 VGA, 2 HDMI/DP, 2 LAN, 1 Line-out, 1 Mic-in, DC9~36V, TPM2.0, F/G SYSTEM RoHS

## PACKING LIST

1 EC500-ADS system unit
1 M.2 slot screws
1 Terminal block 3 pole for DC input
1 Cable with 2 wire stripped and tinned to DC jack

## Assured Systems

Assured Systems is a leading technology company with over 1,500 regular clients in 80 countries, deploying over 85,000 systems to a diverse customer base in 12 years of business. We offer high-quality and innovative rugged computing, display, networking and data collection solutions to the embedded, industrial, and digital-out-of-home market sectors.

### US

[sales@assured-systems.com](mailto:sales@assured-systems.com)

Sales: +1 347 719 4508  
Support: +1 347 719 4508

1309 Coffeen Ave  
Ste 1200  
Sheridan  
WY 82801  
USA

### EMEA

[sales@assured-systems.com](mailto:sales@assured-systems.com)

Sales: +44 (0)1785 879 050  
Support: +44 (0)1785 879 050

Unit A5 Douglas Park  
Stone Business Park  
Stone  
ST15 0YJ  
United Kingdom

VAT Number: 120 9546 28  
Business Registration Number: 07699660