

EC500-CS

Q370
H310
C246



8th/9th Gen Intel® Core™
Modular-Designed Embedded System



KEY FEATURES



DDR4

DDR4 SODIMM up to 64GB



Wide-Temperature

Operating temperature: -20 to 70°C



Three Independent Displays

1 VGA + 2 HDMI/DP++ (auto detection)

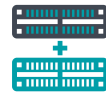

Multiple Expansion

3 M.2 slots (1 M.2 2230 E key, 1 M.2 3042/3052 B key, 1 M.2 2280 M key)



Rich I/O

2 GbE, 6 COM, 4 USB 3.1, 2 USB 2.0 (Q370/C246 only)



Support 5G Communication

Support 5G communication



PANEL

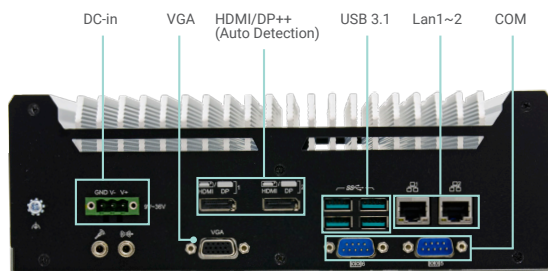

Front View

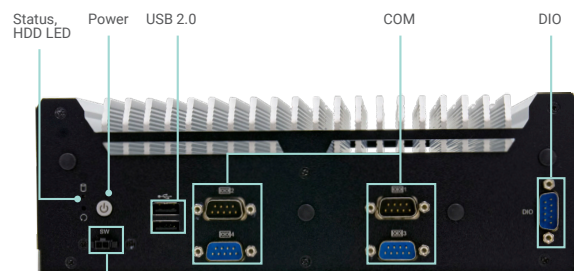

Remote Switch

Rear View

DIMENSIONS

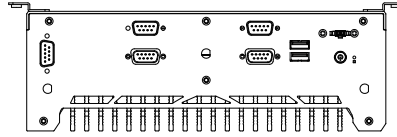

Front View

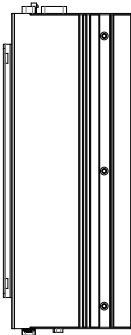

Left View

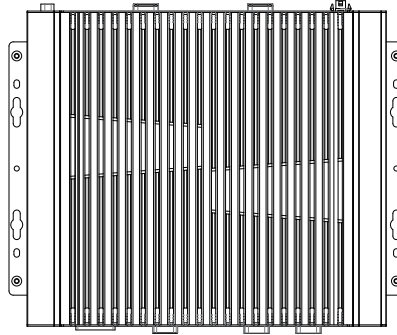

255.30

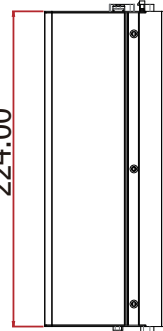

Right View

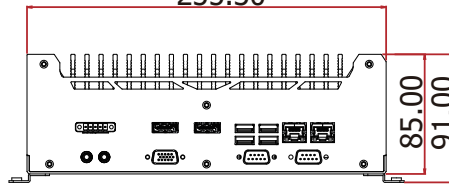

Rear View

WALL MOUNTING

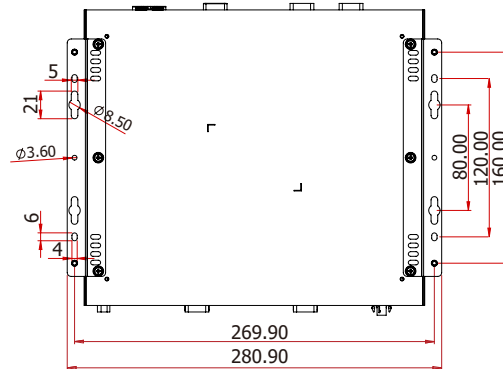
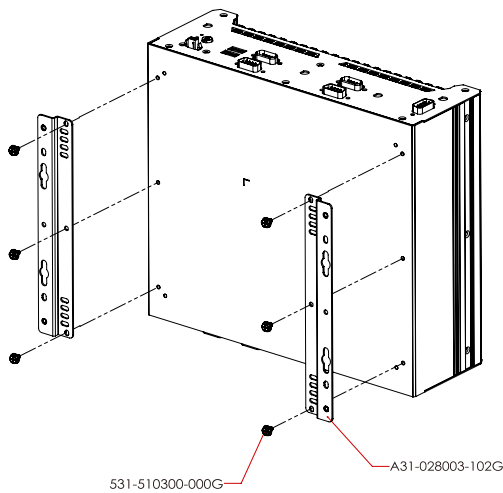

SPECIFICATION

SYSTEM	Processor	8th/9th Generation Intel® Core™ Processors, LGA 1151 Intel® Core™ i7-9700TE , Octa Cores, 12M Cache, up to 3.8 GHz, 35W Intel® Core™ i5-9500TE , Hexa Cores, 9M Cache, up to 3.6 GHz), 35W Intel® Core™ i3-9100TE, Quad Cores, 6M Cache, up to 3.2 GHz, 35W Intel® Core™ i7-8700T Processor, Hexa Core, 12M Cache, 2.4GHz (4GHz), 35W Intel® Core™ i5-8500T Processor, Hexa Core, 9M Cache, 2.1GHz (3.5GHz), 35W Intel® Core™ i3-8100T Processor, Quad Core, 6M Cache, 3.1GHz, 35W Intel® Pentium® Processor G5400T, Dual Core, 4M Cache, 3.1GHz, 35W Intel® Celeron® Processor G4900T, Dual Core, 2M Cache, 3.1GHz, 35W
	Chipset	Intel® Q370/C246/H310 Chipset
	Memory	Two 260-pin DDR4 2400/2666MHz SODIMM up to 64GB
	BIOS	Insyde SPI 128Mbit
	GRAPHICS	Controller
GRAPHICS	Feature	OpenGL up to 5.0, DirectX 11, OpenCL 2.1 HW Decode: HEVC/H.265, H.264, M/JPEG, MPEG2, VC1/WMV9, VP8 (8-bit), VP9 (10-bit) HW Encode: HEVC/H.265, M/JPEG, MPEG2, VP8
	Display	Q370/C246: 1 x VGA 2 x HDMI/DP++ (auto detection) H310: 1 x VGA 1 x HDMI/DP++ (auto detection) VGA: resolution up to 1920x1200 @ 60Hz HDMI: resolution up to 4096x2160 @ 30Hz DP++: resolution up to 4096x2304 @ 60Hz
	Dual/Triple Displays	Q370/C246: 1 x VGA + 2 x HDMI/DP++ (auto detection) H310: 1 x VGA + 1 x HDMI/DP++ (auto detection)
	STORAGE	Internal
EXPANSION	Interface	Q370/C246: 1 x M.2 2230 E key (PCIe/USB 2.0) 1 x M.2 2280 M key (PCIe x4 NVMe/SATA) 1 x M.2 3042/3052 B key (PCIe/USB3.0) H310: 1 x M.2 2230 E key (PCIe/USB 2.0) 1 x M.2 2280 M key (SATA) 1 x M.2 3042/3052 B key (PCIe)
AUDIO	Audio Codec	Realtek ALC888
ETHERNET	Controller	Q370/C246: 1 x Intel® I211AT PCIe (10/100/1000Mbps) 1 x Intel® I219LM with iAMT11.0 PCIe (10/100/1000Mbps) (only Core i7/i5 supports iAMT) H310: 1 x Intel® I211AT PCIe (10/100/1000Mbps) 1 x Intel® I219V PCIe (10/100/1000Mbps)
LED	Indicators	1 x Status LED 1 x HDD LED
FRONT I/O	Serial	4 x RS-232/422/485 (DB-9)
	USB	2 x USB 2.0 (type A)
	DIO	8 bit (DB-9)
	Buttons	1 x Power button 1 x Reset button
	Antenna	4 x Antenna hole
REAR I/O	Ethernet	2 x GbE (RJ-45)
	Serial	2 x RS-232 (DB-9)
	USB	4 x USB 3.1 (type A)
	Display	Q370/C246: VGA + 2 x HDMI/DP++ (auto detection) H310: VGA + 1 x HDMI/DP++ (auto detection)
	Audio	1 x Line-out 1 x Mic-in
WATCHDOG TIMER	Output & Interval	System reset, programmable via software from 1 to 255 seconds
SECURITY	TPM	TPM 2.0
POWER	Type	Wide range 9~36V
	Connector	3-pole terminal nlock 3-pin power extension switch connector
OS SUPPORT	Window	Windows 10 IoT Enterprise 64 Bit
	Linux	Linux (available upon request)

SPECIFICATION

MECHANISM	Construction	Metal + Aluminum
	Mounting	Wall Mount
	Dimensions (W x H x D)	255.3 x 85 x 224mm
	Weight	4.15 kg
ENVIRONMENT	Operating Temperature	-20 to 70°C (SSD or mSATA)
	Storage Temperature	-20 to 85°C
	Relative Humidity	5 to 95% RH (non-condensing)
STANDARDS AND CERTIFICATIONS	Shock	Half sine wave 3G, 11ms, 3 shock per axis
	Vibration	IEC68-2-64
	Certification	CE, FCC Class A

ORDERING INFORMATION

Model Name	Part Number	Description
EC500-CS4061-Q	750-EC5003-000G	EC500-CS4061-Q:Fanless, CS263, Q370, CPU i5-8500T, 6 COM, 6 USB, 1 VGA, 2 HDMI/DP, 2 LAN, 1 Line-out, 1 Mic-in, 8 bits DIO, DC9~36V, F/G SYSTEM RoHS
EC500-CS4061-H	750-EC5003-100G	EC500-CS4061-H:Fanless, CS263, H310, CPU i5-8500T, 6 COM, 6 USB, 1 VGA, 1 HDMI/DP, 2 LAN, 1 Line-out, 1 Mic-in, 8 bits DIO, DC9~36V, F/G SYSTEM RoHS
EC500-CS4061-C	750-EC5003-200G	EC500-CS4061-C:Fanless, CS263, C246, CPU i5-8500T, 6 COM, 6 USB, 1 VGA, 2 HDMI/DP, 2 LAN, 1 Line-out, 1 Mic-in, 8 bits DIO, DC9~36V, F/G SYSTEM RoHS

PACKING LIST

1 EC500-CS system unit
1 M.2 slot & Mini-PCIe slot screws
1 terminal block 5 pole for DC input
1 cable with 2 wire stripped and tinned to DC jack

Assured Systems

Assured Systems is a leading technology company with over 1,500 regular clients in 80 countries, deploying over 85,000 systems to a diverse customer base in 12 years of business. We offer high-quality and innovative rugged computing, display, networking and data collection solutions to the embedded, industrial, and digital-out-of-home market sectors.

US

sales@assured-systems.com

Sales: +1 347 719 4508
Support: +1 347 719 4508

1309 Coffeen Ave
Ste 1200
Sheridan
WY 82801
USA

EMEA

sales@assured-systems.com

Sales: +44 (0)1785 879 050
Support: +44 (0)1785 879 050

Unit A5 Douglas Park
Stone Business Park
Stone
ST15 0YJ
United Kingdom

VAT Number: 120 9546 28
Business Registration Number: 07699660