

EC70A-TGU

11th Gen Intel® Core™
Fanless Robust Embedded System



KEY FEATURES



Tiger Lake

Intel® 11th Gen Core™ Tiger Lake UP3 Processor, TDP=15W



Triple Displays

2 HDMI (4K@30Hz) + 1 VGA (2K@60Hz)



On Board Memory

On board memory and 1 SO-DIMM DDR4



5G Support

Support M.2 B key 3042/3052 5G-NR module



Rich I/O

Up to 4 LAN, or 6 USB



PANEL



Front View



Rear View
SKU 1



Rear View
SKU 2



Rear View
SKU 3

DIMENSIONS

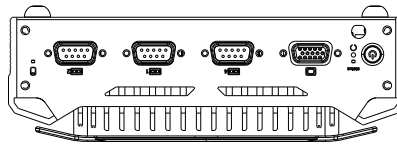

Front View

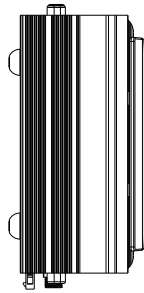

Left View

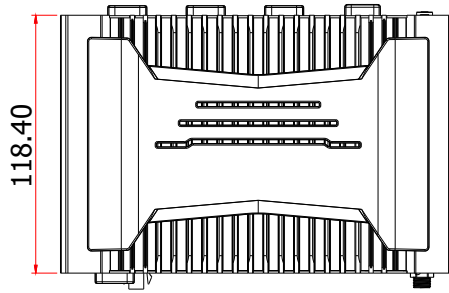

118.40

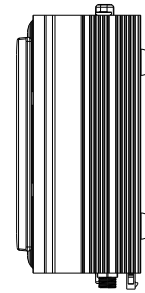

Right View

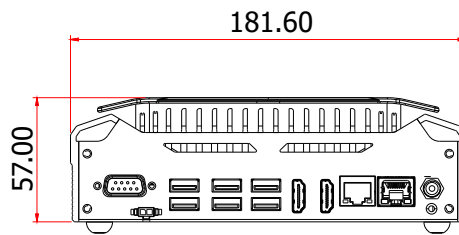

181.60

57.00

Rear View

WALL MOUNTING

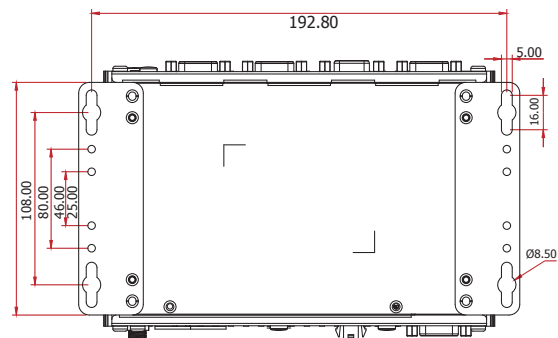
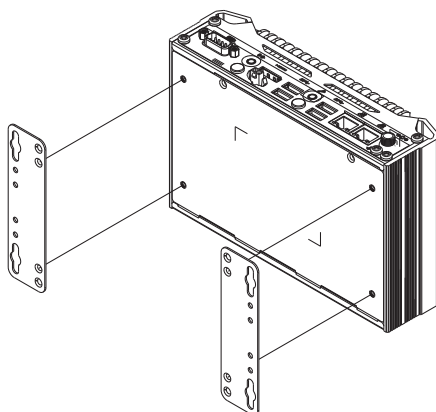

SPECIFICATION

SYSTEM	Processor	11th Gen Intel® Core™ i7/i5/i3 Processors Intel Embedded Series Intel® Core™ i7-1185G7E Processor, 4C8T, 12M Cache, 1.8GHz (4.4GHz), 15W Intel® Core™ i5-1145G7E Processor, 4C8T, 8M Cache, 1.5GHz (4.1GHz), 15W Intel® Core™ i3-1115G4E Processor, 2C4T, 6M Cache, 2.2GHz (3.9GHz), 15W Intel Industrial Series Intel® Core™ i7-1185GRE Processor, 4C8T, 12M Cache, 1.8GHz (4.4GHz), 15W Intel® Core™ i5-1145GRE Processor, 4C8T, 8M Cache, 1.5GHz (4.1GHz), 15W Intel® Core™ i3-1115GRE Processor, 2C4T, 6M Cache, 2.2GHz (3.9GHz), 15W	
	Memory	8GB On-board memory & one SO-DIMM DDR4	
	BIOS	AMI SPI 256Mbit	
GRAPHICS	Controller	Intel® Iris® Xe Graphics for i7/i5 Processors Intel® UHD Graphics for i3/Celeron Processors	
	Feature	OpenGL 4.5, DirectX 12, OpenCL 2.1 HW Decode: WMV9, AVC/H264, JPEG/MJPEG, HEVC/H265, VP9, AV1 HW Encode: AVC/H264, JPEG, HEVC/H265, VP9	
	Display	2 x HDMI 1 x VGA	HDMI: resolution up to 4096x2160@30Hz VGA: resolution up to 1920x1200@60Hz
	Triple Displays	1 VGA + 2 HDMI	
STORAGE	Internal	1 x M.2 2280 M key (PCIe x4)	
EXPANSION	Interface	1 x M.2 2280 M key (PCIe x4) 1 x M.2 3042/3052 B key (USB3.1) 1 x M.2 2230 E Key (PCIe/USB2.0)	
	Ethernet	(SKU 1) 1 x Intel® I210IT 1 x Intel® I225IT (SKU 2) 2 x Intel® I210IT 1 x Intel® I225IT (SKU 3) 2 x Intel® I210IT, 1 x LAN7500i 1 x Intel® I225IT	
LED	Indicators	1 x Power LED 1 x HDD LED	
FRONT I/O	Serial	2 x RS-232/422/485 (DB-9, COM 1~2) 1 x RS232 (DB9, COM 4)	
	Display	1 x VGA	
	Buttons	1 x Power button 1 x Reset button	
REAR I/O	Ethernet	(SKU1) 2 x GbE (RJ-45) (SKU2) 3 x GbE (RJ-45) (SKU3) 4 x GbE (RJ-45)	
	Serial	1 x RS-232 or DIO (DB-9, COM 3)	
	USB	(SKU 1) 6 x USB 3.1 (type A) (SKU 2) 4 x USB 3.1 (type A) (SKU 3) 2 x USB 3.1 (type A)	
	Display	2 x HDMI	
WATCHDOG TIMER	Output & Interval	System Reset, Programmable via Software from 1 to 255 Seconds	
POWER	Type	Wide range 9~36V	
	Connector	DC Jack	
OS SUPPORT	OS Support	Windows 10 IoT Linux OS	
ENVIRONMENT	Operating Temperature	-20 to 60°C (wide-temp SSD)	
	Storage Temperature	-20 to 85°C	
	Relative Humidity	5 to 95% RH (non-condensing)	
MECHANISM	Construction	Aluminum + Metal Aluminum	
	Mounting	Wall/VESA/DIN rail mount	
	Dimensions (W x H x D)	181.6mm x 57mm x 118.4mm	
	Weight	1.28 kg	
STANDARDS AND CERTIFICATIONS	Shock	Operating: IEC 60068-2-27 Test Ea: Shock Test Half-Sine, 3G @ 11ms, 18 Shock ±X, ±Y, ±Z (each axis 3 times)	
	Vibration	Operating: IEC 60068-2-64 Test Fh: Vibration Board-Band Random Test Random, 1Grms @ 5~500 Hz, 30min Non-Operating: IEC 60068-2-6 Test Fc: Vibration Sinusoidal Test Sweep Sine, 3Grms @ 10~500Hz, 30min	
	Certifications	CE, FCC Class A, UKCA, UL, CCC, RoHS	

ORDERING INFORMATION

Model Name	Part Number	Description
EC70A-TGU4062-C5E-8	750-EC70A2-000G	Celeron 6305E, 8GB memory, 4 COM, 6 USB, 2 HDMI, 1 VGA, 2 LAN, DC 9~36V input, TPM2.0, F/G SYSTEM RoHS
EC70A-TGU4062-I3E-8	750-EC70A2-100G	i3-1115G4E, 8GB memory, 4 COM, 6 USB, 2 HDMI, 1 VGA, 2 LAN, DC 9~36V input, TPM2.0, F/G SYSTEM RoHS
EC70A-TGU4062-I5E-8	750-EC70A2-200G	i5-1145G7E, 8GB memory, 4 COM, 6 USB, 2 HDMI, 1 VGA, 2 LAN, DC 9~36V input, TPM2.0, F/G SYSTEM RoHS
EC70A-TGU4062-I7E-8	750-EC70A2-300G	i7-1185G7E, 8GB memory, 4 COM, 6 USB, 2 HDMI, 1 VGA, 2 LAN, DC 9~36V input, TPM2.0, F/G SYSTEM RoHS
EC70A-TGU4043-C5E-8	750-EC70A2-400G	Celeron 6305E, 8GB memory, 4 COM, 4 USB, 2 HDMI, 1 VGA, 3 LAN, DC 9~36V input, TPM2.0, F/G SYSTEM RoHS
EC70A-TGU4043-I3E-8	750-EC70A2-500G	i3-1115G4E, 8GB memory, 4 COM, 4 USB, 2 HDMI, 1 VGA, 3 LAN, DC 9~36V input, TPM2.0, F/G SYSTEM RoHS
EC70A-TGU4043-I5E-8	750-EC70A2-600G	i5-1145G7E, 8GB memory, 4 COM, 4 USB, 2 HDMI, 1 VGA, 3 LAN, DC 9~36V input, TPM2.0, F/G SYSTEM RoHS
EC70A-TGU4043-I7E-8	750-EC70A2-700G	i7-1185G7E, 8GB memory, 4 COM, 4 USB, 2 HDMI, 1 VGA, 3 LAN, DC 9~36V input, TPM2.0, F/G SYSTEM RoHS
EC70A-TGU4024-I7E-8	750-EC70A2-800G	i7-1185G7E, 8GB memory, 4 COM, 2 USB, 2 HDMI, 1 VGA, 4 LAN, DC 9~36V input, TPM2.0, F/G SYSTEM RoHS
EC70A-TGU4062-I7R-8	750-EC70A2-900G	i7-1185GRE, 8GB memory, 4 COM, 6 USB, 2 HDMI, 1 VGA, 2 LAN, DC 9~36V input, TPM2.0, F/G SYSTEM RoHS
EC70A-TGU4024-I5E8	750-EC70A2-A00G	i5-1145G7E, 8GB memory, 4 COM, 2 USB, 2 HDMI, 1 VGA, 4 LAN, DC 9~36V input, TPM2.0, F/G SYSTEM RoHS

PACKING LIST

1 EC70A-TGU system unit
3 M.2 slot slot screws
4 Foot screws & Rubber Foot
1 Grounding screw
1 Remote switch cable

Assured Systems

Assured Systems is a leading technology company with over 1,500 regular clients in 80 countries, deploying over 85,000 systems to a diverse customer base in 12 years of business. We offer high-quality and innovative rugged computing, display, networking and data collection solutions to the embedded, industrial, and digital-out-of-home market sectors.

US

sales@assured-systems.com

Sales: +1 347 719 4508
Support: +1 347 719 4508

1309 Coffeen Ave
Ste 1200
Sheridan
WY 82801
USA

EMEA

sales@assured-systems.com

Sales: +44 (0)1785 879 050
Support: +44 (0)1785 879 050

Unit A5 Douglas Park
Stone Business Park
Stone
ST15 0YJ
United Kingdom

VAT Number: 120 9546 28
Business Registration Number: 07699660