



ASLAN-W919C

Fanless 18.5" Wide-Screen Industrial Panel PC with Intel® Core i5-6300U
2.4GHz Processor



Features

- 18.5" LCD Display w/ LED Backlight
- Flat panel with projected capacitive touchscreen
- Front panel compliant with IP65
- Anti-scratch surface: 7H hardness
- Easy Maintenance Design for HDD/SSD
- Serial Ports (RS-232/422/485), RS-485 w/ Auto-flow Control
- Mini PCIe expansion slot support
- Fanless cooling system
- Cable-less Design
- Low power consumption
- 2 x SMA Antenna Holes for optional WiFi Function

Industrial Automation System

System	
CPU	Intel® Core i5-6300U™ Processor 2.4GHz 4GB DDR4 SO-DIMM pre-installed
Memory	1 x 260-pin DDR4 SO-DIMM socket, supporting 2133MHz SDRAM up to 16GB
LAN Chipset	1 x Intel® i219LM PCIe controller w/ iAMT 1 x Intel® i210IT PCIe controller
Watchdog Timer	1~255 levels reset
Storage	
Device	2 x 2.5" drive bay (default), 1 x mSATA
Audio	
Device	Line Out / Mic In (Optional)
LCD Display	
Size/Type	18.5" TFT LCD Panel
Max. Resolution	1366 x 768, WXGA
Max. Colors	16.2M
Luminance	300 cd/m ²
Touch Screen	Projected capacitive touch panel
View Angle (U/D/R/L)	80°/80°/85°/85°
Power System	
Power Input	9~36VDC
Power Consumption	Max. 29.0W (w/o I/O cards)
Qualification	
Certification	CE, FCC Class A
Expansion	
Expansion Bus	1 x mSATA (SATA, Full Size) 1 x mPCIe (PCIex1+USB2.0, Full Size) 1 x mPCIe (PCIex1+USB2.0, Half Size)

External I/O	
Serial Ports	4 x RS-232/422/485
USB Ports	4 x Type-A USB 3.0/2.0 ports
LAN	2 x RJ-45 GbE ports
Video	1 x VGA / 1 x HDMI
DIO	4IN / 4OUT Digital I/O (optional)
Mechanical	
Mounting Type	Panel Mounting and VESA-100 Mounting
Chassis	Panel-mounting chassis, aluminum front bezel and SGCC steel chassis
Dimension (W x H x D)	470 x 295 x 56.2 mm (18.5" x 11.6" x 2.21")
Weight (Net)	5.68 kg (12.52 lb)
Environmental	
Operating Temp.	-20°C ~ 55°C (-4°F ~ 131°F)
Storage Temp.	-30°C ~ 70°C (-22°F ~ 158°F)
Operating Humidity	10 ~ 95% RH @ 55°C (non-condensing)
Vibration	5 ~ 500Hz, 1Grms Random (w/ SSD)
Shock	Operating 10G, 11ms Non-operating 30G, 11ms (w/ SSD)
OS Support	
Windows 7 / Windows 8.1 / Windows 10 / Linux: Ubuntu	
Ordering Information	
ASLAN -W919C-6300G4	18.5" Intel® Core i5-6300U 2.4GHz Processor Wide-screen industrial panel PC with 4GB Memory



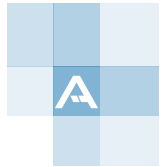

All specifications are subject to change without notice.

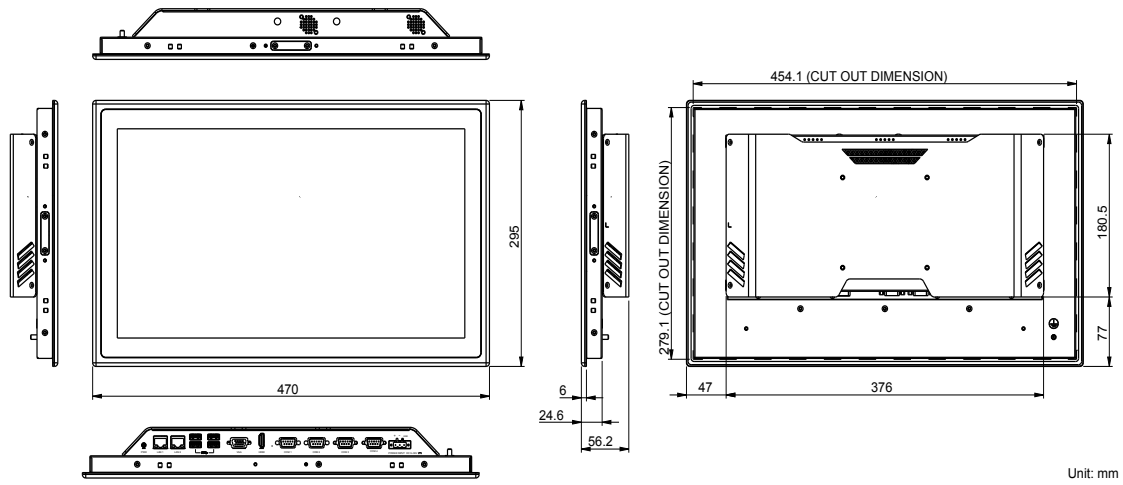

Dimensions



Optional Accessories

PAC-60W6A-FSP-ES	12V/5A 60W AC/DC power adapter kit	
64/128/256GB SSD	2.5" SSD MLC 64/128/256GB	
WiFi-AT4550	Atheros QCNFA324 Wi-Fi module w/ 2*30cm internal wiring	
ANT-D11	1 x Wi-Fi Dual-band 2.4G/5G antenna	
SCK-722C	Assembly kit for SiP-41B/42B	

Assured Systems

Assured Systems is a leading technology company with over 1,500 regular clients in 80 countries, deploying over 85,000 systems to a diverse customer base in 12 years of business. We offer high-quality and innovative rugged computing, display, networking and data collection solutions to the embedded, industrial, and digital-out-of-home market sectors.

US

sales@assured-systems.com

Sales: +1 347 719 4508
Support: +1 347 719 4508

1309 Coffeen Ave
Ste 1200
Sheridan
WY 82801
USA

EMEA

sales@assured-systems.com

Sales: +44 (0)1785 879 050
Support: +44 (0)1785 879 050

Unit A5 Douglas Park
Stone Business Park
Stone
ST15 0YJ
United Kingdom

VAT Number: 120 9546 28
Business Registration Number: 07699660