

DFI[®]



EC700-BT

Fanless Embedded System
User's Manual

A33130546

Copyright

This publication contains information that is protected by copyright. No part of it may be reproduced in any form or by any means or used to make any transformation/adaptation without the prior written permission from the copyright holders.

This publication is provided for informational purposes only. The manufacturer makes no representations or warranties with respect to the contents or use of this manual and specifically disclaims any express or implied warranties of merchantability or fitness for any particular purpose. The user will assume the entire risk of the use or the results of the use of this document. Further, the manufacturer reserves the right to revise this publication and make changes to its contents at any time, without obligation to notify any person or entity of such revisions or changes.

Changes after the publication's first release will be based on the product's revision. The website will always provide the most updated information.

© 2015. All Rights Reserved.

Trademarks

Product names or trademarks appearing in this manual are for identification purpose only and are the properties of the respective owners.

FCC and DOC Statement on Class B

This equipment has been tested and found to comply with the limits for a Class B digital device, pursuant to Part 15 of the FCC rules. These limits are designed to provide reasonable protection against harmful interference when the equipment is operated in a residential installation. This equipment generates, uses and can radiate radio frequency energy and, if not installed and used in accordance with the instruction manual, may cause harmful interference to radio communications. However, there is no guarantee that interference will not occur in a particular installation. If this equipment does cause harmful interference to radio or television reception, which can be determined by turning the equipment off and on, the user is encouraged to try to correct the interference by one or more of the following measures:

- Reorient or relocate the receiving antenna.
- Increase the separation between the equipment and the receiver.
- Connect the equipment into an outlet on a circuit different from that to which the receiver is connected.
- Consult the dealer or an experienced radio TV technician for help.

Notice:

1. The changes or modifications not expressly approved by the party responsible for compliance could void the user's authority to operate the equipment.
2. Shielded interface cables must be used in order to comply with the emission limits.

Table of Contents

Copyright	2	Digital I/O Power Select	19
Trademarks	2	Digital I/O Output State	19
FCC and DOC Statement on Class B	2	LCD/Inverter Power Select	20
About this Manual	4	COM 4/DIO Select	20
Warranty	4	Chapter 5 - Ports and Connectors	21
Static Electricity Precautions	4	Front Panel I/O Ports	21
Safety Measures	4	Rear Panel I/O Ports	21
Safety Precautions	5	USB Ports	22
About the Package	5	COM (Serial) Ports	23
Chapter 1 - Introduction	6	Graphics Interfaces	24
Overview	6	9~36V DC-in	25
Key Features	6	RJ45 LAN Ports	25
Specifications	7	I/O Connectors	26
Getting the Know the EC700-BT	8	Serial ATA Connector	26
Mechanical Dimensions	9	Serial ATA Power Connector	26
Chapter 2 - Getting Started	10	Cooling Fan Connector	26
Preparing the System	10	LVDS LCD Panel with Power Connector	27
Installing Devices	10	Mic-in Connector	28
Configuring the BIOS	10	Chassis Intrusion Connector	28
Installing the Operating System	10	Expansion Slots	29
Installing the Drivers	10	Standby Power LED	29
Chapter 3 - Installing Devices	11	Battery	30
Removing the Chassis Cover	11	Chapter 6 - Mounting Options	31
Installing a 2.5" SATA Drive	12	Wall Mount	31
Installing a SIM Card	13	VESA Mount	32
Installing a Mini PCIe and/or mSATA Card	13	DIN Rail Mount	33
Installing the Mini PCIe Card	13	Chapter 7 - BIOS Setup	35
Installing the mSATA Card	14	Overview	35
Chapter 4 - Jumper Settings	16	AMI BIOS Setup Utility	36
Clear CMOS Data	16	Updating the BIOS	52
Auto Power-on Select	16	Notice: BIOS SPI ROM	52
USB Power Select	17	Chapter 8 - Supported Software	53
Panel Power Select	17	Chapter 9 - Digital I/O Programming Guide	65
Backlight Power Select	18	Appendix A - Watchdog Sample Code	67
Dimming Mode Select	18	Appendix B - System Error Message	68
		Appendix C - Troubleshooting Checklist	69

About this Manual

An electronic file of this manual is included in the CD. To view the user's manual in the CD, insert the CD into a CD-ROM drive. The autorun screen (Main Board Utility CD) will appear. Click "User's Manual" on the main menu.

Warranty

1. Warranty does not cover damages or failures that arised from misuse of the product, inability to use the product, unauthorized replacement or alteration of components and product specifications.
2. The warranty is void if the product has been subjected to physical abuse, improper installation, modification, accidents or unauthorized repair of the product.
3. Unless otherwise instructed in this user's manual, the user may not, under any circumstances, attempt to perform service, adjustments or repairs on the product, whether in or out of warranty. It must be returned to the purchase point, factory or authorized service agency for all such work.
4. We will not be liable for any indirect, special, incidental or consequential damages to the product that has been modified or altered.

Static Electricity Precautions

It is quite easy to inadvertently damage your PC, system board, components or devices even before installing them in your system unit. Static electrical discharge can damage computer components without causing any signs of physical damage. You must take extra care in handling them to ensure against electrostatic build-up.

1. To prevent electrostatic build-up, leave the system board in its anti-static bag until you are ready to install it.
2. Wear an antistatic wrist strap.
3. Do all preparation work on a static-free surface.
4. Hold the device only by its edges. Be careful not to touch any of the components, contacts or connections.
5. Avoid touching the pins or contacts on all modules and connectors. Hold modules or connectors by their ends.



Important:

Electrostatic discharge (ESD) can damage your processor, disk drive and other components. Perform the upgrade instruction procedures described at an ESD workstation only. If such a station is not available, you can provide some ESD protection by wearing an antistatic wrist strap and attaching it to a metal part of the system chassis. If a wrist strap is unavailable, establish and maintain contact with the system chassis throughout any procedures requiring ESD protection.

Safety Measures

To avoid damage to the system:

- Use the correct AC input voltage range.

To reduce the risk of electric shock:

- Unplug the power cord before removing the system chassis cover for installation or servicing. After installation or servicing, cover the system chassis before plugging the power cord.

Battery:

- Danger of explosion if battery incorrectly replaced.
- Replace only with the same or equivalent type recommend by the manufacturer.
- Dispose of used batteries according to local ordinance.

Safety Precautions

- Use the correct DC input voltage range.
- Unplug the power cord before removing the system chassis cover for installation or servicing. After installation or servicing, cover the system chassis before plugging the power cord.
- Danger of explosion if battery incorrectly replaced.
- Replace only with the same or equivalent type recommend by the manufacturer.
- Dispose of used batteries according to local ordinance.
- Keep this system away from humidity.
- Place the system on a stable surface. Dropping it or letting it fall may cause damage.
- The openings on the system are for air ventilation to protect the system from overheating. **DO NOT COVER THE OPENINGS.**
- Place the power cord in such a way that it will not be stepped on. Do not place anything on top of the power cord. Use a power cord that has been approved for use with the system and that it matches the voltage and current marked on the system's electrical range label.
- If the system will not be used for a long time, disconnect it from the power source to avoid damage by transient overvoltage.
- If one of the following occurs, consult a service personnel:
 - The power cord or plug is damaged.
 - Liquid has penetrated the system.
 - The system has been exposed to moisture.
 - The system is not working properly.
 - The system dropped or is damaged.
 - The system has obvious signs of breakage.
- The unit uses a three-wire ground cable which is equipped with a third pin to ground the unit and prevent electric shock. Do not defeat the purpose of this pin. If your outlet does not support this kind of plug, contact your electrician to replace the outlet.
- Disconnect the system from the DC outlet before cleaning. Use a damp cloth. Do not use liquid or spray detergents for cleaning.

About the Package

The package contains the following items. If any of these items are missing or damaged, please contact your dealer or sales representative for assistance.

- 1 EC700-BT system unit
- Mounting screws for SATA drive
- Mounting screws for Mini PCIe module
- 1 CD disk includes
 - Manual
 - Drivers
- 1 Quick Installation Guide

Optional Items

- Wall Mount kit
- VESA Mount kit
- Power Cord

The board and accessories in the package may not come similar to the information listed above. This may differ in accordance to the sales region or models in which it was sold. For more information about the standard package in your region, please contact your dealer or sales representative.

Before Using the System

Before powering-on the system, prepare the basic system components.

If you are installing the system board in a new system, you will need at least the following internal components.

- Storage devices such as CFast card, Mini PCIe and/or mSATA card, etc.

You will also need external system peripherals you intend to use which will normally include at least a keyboard, a mouse and a video display monitor.

Chapter 1 - Introduction

Overview



Front View



Rear View

Key Features

Model Name	EC700-BT
Processor	Intel® Atom™/Intel® Celeron® processors
Memory	4GB/2GB DDR3L onboard
LAN	2 LAN ports
COM	4 COM ports
Display	1 HDMI, 1 VGA or 1 DVI-I* (optional)
USB	1 Type A USB 3.0 port at the front panel; 4 Type A USB 2.0 ports at the rear panel
DIO	1 8-bit DIO via the DB-9 port

Chapter 1

Specifications

Processor System	<ul style="list-style-type: none"> Intel® Atom™/Intel® Celeron® processors - Intel® Atom™ E3845, Quad Core, 2M Cache, 1.91GHz, 10W - Intel® Atom™ E3825, Dual Core, 1M Cache, 1.33GHz, 6W - Intel® Celeron® J1900, Quad Core, 2M Cache, 2GHz (2.41GHz), 10W - Intel® Celeron® N2807, Dual Core, 1M Cache, 1.58GHz (2.16GHz), 4.3W BGA 1170 packaging technology
Memory	<ul style="list-style-type: none"> 4GB/2GB DDR3L ECC onboard (-E45/-E25) 4GB/2GB DDR3L non-ECC onboard (-J19/-N28) Supports DDR3L 1333MHz (-E45/-J19/-N28) Supports DDR3L 1066MHz (-E25) Supports single channel memory interface
Graphics	<ul style="list-style-type: none"> Intel® HD Graphics Display ports: 1 HDMI, 1 VGA, or 1 DVI-I* (optional) HDMI, DVI: resolution up to 1920x1080 @ 60Hz VGA: 24-bit, resolution up to 2560x1600 @ 60H
Storage	<ul style="list-style-type: none"> 1 2.5" SATA drive bay - SATA 2.0 port with data transfer rate up to 3Gb/s 1 mSATA module via a Mini PCIe slot Supports 4GB, 8GB, 16GB and 32GB eMMC onboard* (optional)
Ethernet	<ul style="list-style-type: none"> 2 Intel® I210 PCI Express Gigabit Ethernet controllers Integrated 10/100/1000 transceiver Fully compliant with IEEE 802.3, IEEE 802.3u, IEEE 802.3ab
Expansion	<ul style="list-style-type: none"> 3 Mini PCIe slots - 2 slots for communication <ul style="list-style-type: none"> : One half size slot supports PCIe, USB, and LPC signals for Wi-Fi module or LPC module : One full size slot supports PCIe, USB, and 3G signals for 3G or GPRS module - 1 full size slot for storage <ul style="list-style-type: none"> : Supports mSATA module 1 SIM card socket 1 microSD socket* (optional)
DIO	<ul style="list-style-type: none"> 1 8-bit DIO via the DB-9 port
I/O Ports	<ul style="list-style-type: none"> Front Panel <ul style="list-style-type: none"> - 3 DB-9 serial ports <ul style="list-style-type: none"> : supports RS232/422/485 : One of the ports supports 8-bit DIO - 1 USB 3.0 (Type A) port - 1 HDMI port - 3 Wi-Fi antenna holes - 1 status LED - 1 HDD LED - 1 reset button - 1 power button Rear Panel <ul style="list-style-type: none"> - 1 DB-9 serial port <ul style="list-style-type: none"> : supports RS232/422/485 - 1 VGA port; or 1 DVI-I port* (optional) - 4 USB 2.0 (Type A) ports - 2 RJ45 LAN ports - 1 9~36V DC-in jack

COM	<ul style="list-style-type: none"> 4 DB-9 ports - 3 DB-9 ports support RS232/422/485 COM port - 1 DB-9 port supports RS232/422/485 COM or 8-bit DIO
Trusted Platform Module - TPM* (optional)	<ul style="list-style-type: none"> Provides a Trusted PC for secure transactions Provides software license protection, enforcement and password protection
Power	<ul style="list-style-type: none"> Power input voltage: 9~36V DC-in jack
Environment	<ul style="list-style-type: none"> Temperature <ul style="list-style-type: none"> - Operating (E3845/E3825) <ul style="list-style-type: none"> : -20°C~60°C (SSD/mSATA) : 0°C~50°C (HDD) - Operating (J1900/N2807) <ul style="list-style-type: none"> : 0°C~60°C (SSD/mSATA) : 0°C~50°C (HDD) - Storage: -20°C~85°C Operating Vibration <ul style="list-style-type: none"> - IEC68-2-64 (3G) (SSD/mSATA) - IEC68-2-64 (1G) (HDD) Operating Shock <ul style="list-style-type: none"> - Half sine wave 15G, 11ms, 3 shock per axis (SSD/mSATA) - Half sine wave 3G, 11ms, 3 shock per axis (HDD)
Construction	<ul style="list-style-type: none"> Aluminum + metal aluminum
Mounting	<ul style="list-style-type: none"> Wall/VESA/DIN Rail mount - Mounting brackets and screws* (optional)
Dimensions	<ul style="list-style-type: none"> 180mm x 33mm x 121.2mm (W x H x D)
Weight	<ul style="list-style-type: none"> 800g
OS Support	<ul style="list-style-type: none"> Windows 7, WES 7, Windows 8, WES 8, Windows 8.1 Linux (Distribution available upon request)
WatchDog Timer	<ul style="list-style-type: none"> Watchdog timeout programmable via software from 1 to 255 seconds
Certification	<ul style="list-style-type: none"> CE FCC Class B RoHS UL



Note:

*Optional and is not supported in standard model. Please contact your sales representative for more information.

Chapter 1

Getting to Know the EC700-BT

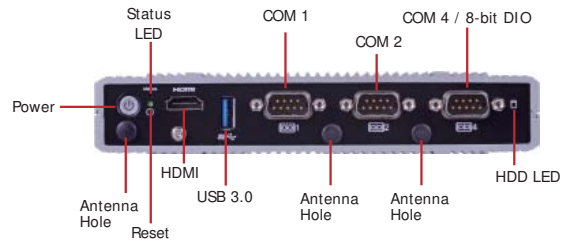
Front View



Antenna Holes

Used to connect to a Wi-Fi antenna.

USB Port

Used to connect USB 3.0 device.

COM Ports

Used to connect serial devices.

HDMI Port

Use to connect an HDMI device.

Status LED

This LED will blink when the system is in the standby mode.

HDD LED

Indicates the status of the hard drive.

Reset Button

Press to reset the system.

Power

Press to power-on or power-off the system.

Rear View

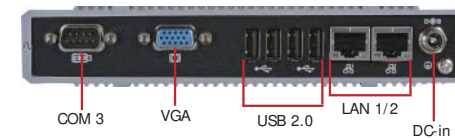

VGA Port

Used to connect a VGA device.

USB Port

Used to connect USB 2.0 devices.

COM Port

Used to connect serial devices.

LAN Ports

Used to connect the system to a local area network.

DC-in jack

Used to plug a power adapter.

Mechanical Dimensions

Chassis Dimension

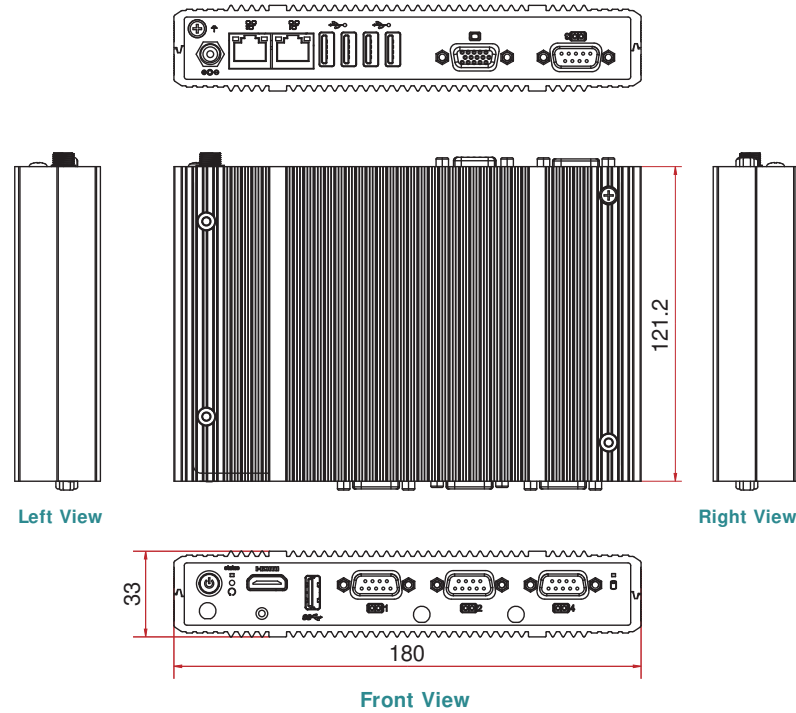

Motherboard Dimension

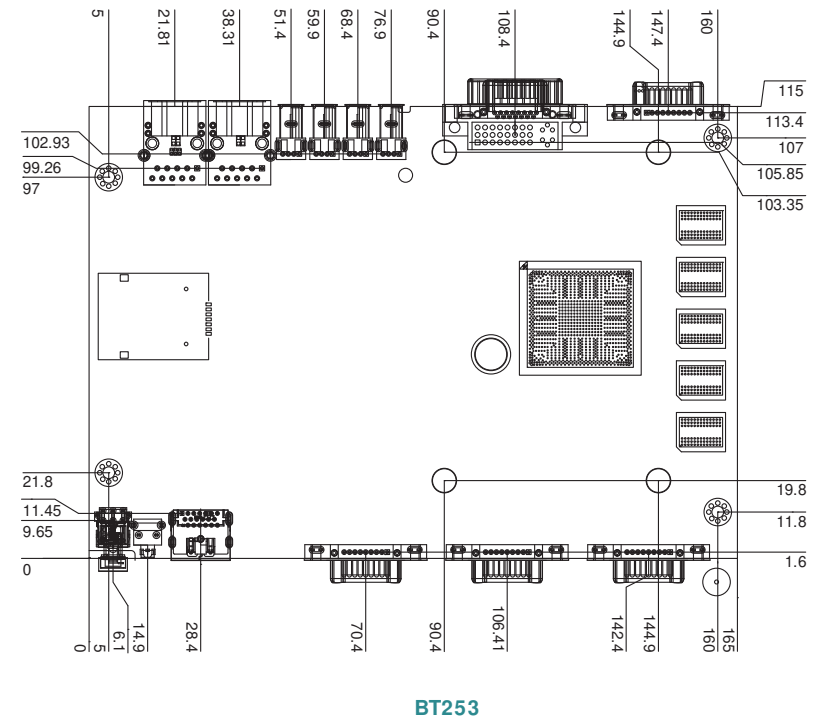

Chapter 2 - Getting Started

Preparing the System

Before you start using the system, you need the following items:

- SATA hard drive
- AC power adapter
- CD-ROM drive (for installing software/drivers)
- Screwdriver

Installing Devices

The following are devices that can be installed in the system.

- SATA hard drive
- Mini PCIe card

Configuring the BIOS

To get you started, you may need to change configurations such as the date, time and the type of hard disk drive.

1. Power-on the system.
2. After the memory test, the message "Press DEL to run setup" will appear on the screen. Press the Delete key to enter the AMI BIOS setup utility.

Installing the Operating System

Most operating system software are provided in a CD therefore you need to install a CD-ROM drive in order to use the CD.

Make sure a 2.5" SATA drive is already installed.

1. Refer to the following chapters for information on connecting a CD-ROM drive and installing a SATA drive.
2. Refer to your operating system manual for instructions on installing the operating system.

Installing the Drivers

The system package includes a CD disk. The CD includes drivers that must be installed to provide the best system performance. Refer to the Supported Software chapter for instructions on installing the drivers.

Chapter 3 - Installing Devices

Removing the Chassis Cover

1. Make sure the system and all other peripheral devices connected to it has been powered-off.
2. Disconnect all power cords and cables.
3. The 4 mounting screws on the bottom side of the system are used to secure the cover to the chassis. Remove these screws and then put them in a safe place for later use.



4. After removing the mounting screws, lift the cover up.



5. The 3 Mini PCIe slots, the microSD socket and the HDD bracket are readily accessible after removing the bottom side of the chassis cover.

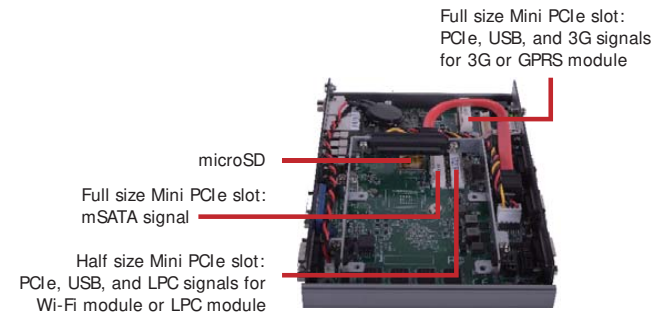

6. The SIM slot is readily accessible after removing the screw on the middle of the motherboard (under the HDD if it has already been installed into the system) and 4 screws on the top side of the chassis cover.

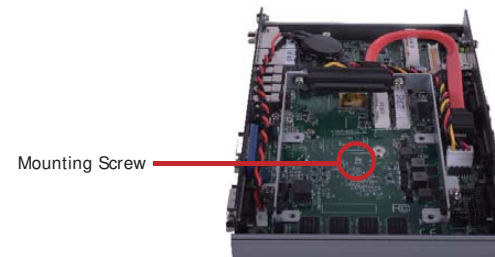

removing the screw on the middle of the motherboard

Chapter 3

Installing a 2.5" SATA Drive

1. Locate the SATA drive bay on the system board. Unplug the SATA power and data cable, and remove the 4 mounting screws that secure the drive bay to the system board.

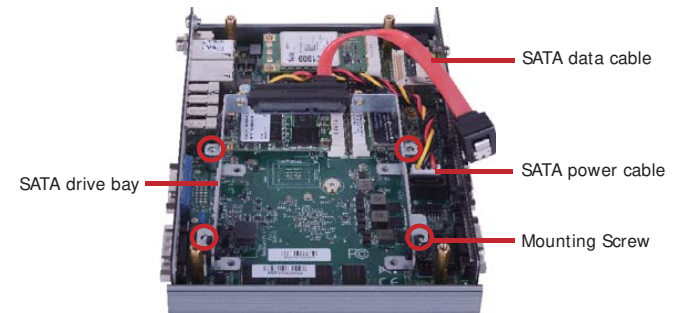
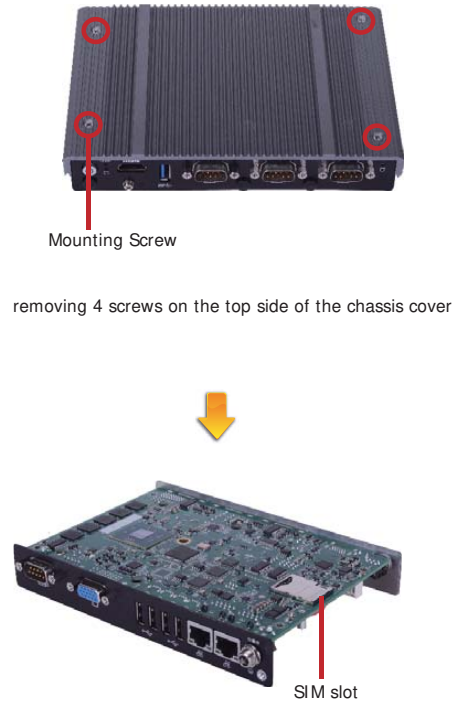

2. Align the mounting holes of the SATA drive with the mounting holes on the HDD bracket and then use the 3 provided mounting screws to secure the drive in place.

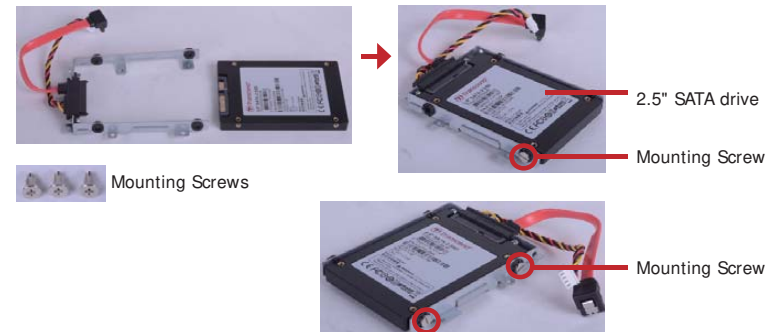

Chapter 3

3. Place the SATA drive bay into the chassis. Secure the SATA drive bay with the mounting screws you removed in step 1. And connect the SATA data cable and SATA power cable to the connectors on the system board.

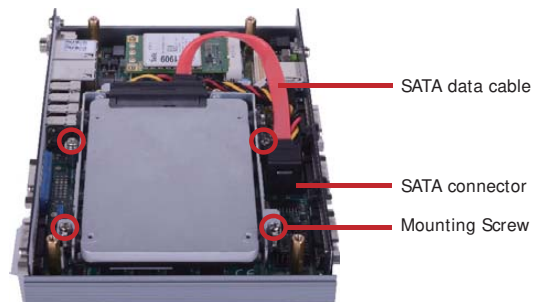
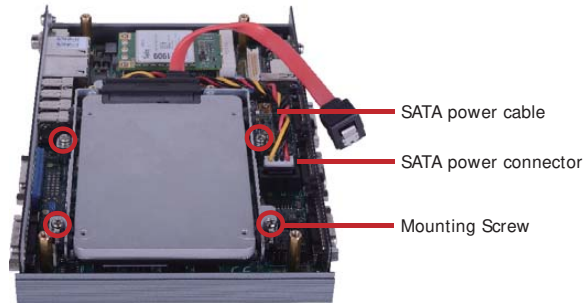

Installing a SIM Card

1. Locate the SIM slot on the system board.

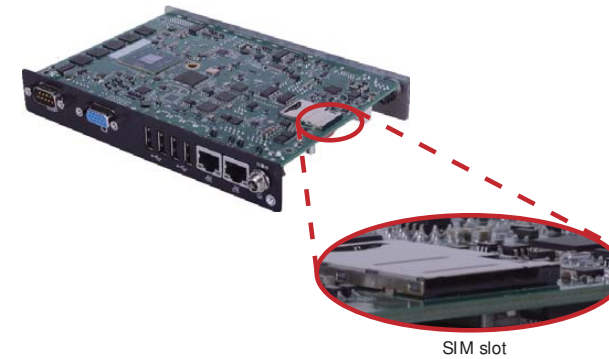

2. Insert the SIM card in the SIM slot, and push the SIM card to take the card out of the slot.

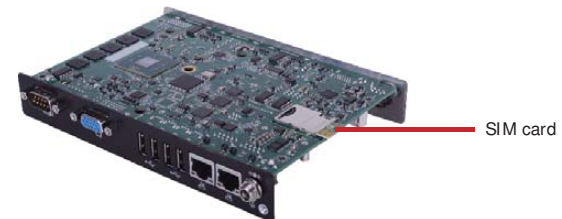

Chapter 3

Installing a Mini PCIe and/ or mSATA card

Installing the Mini PCIe Card

1. Locate the Mini PCIe slot on the system board.

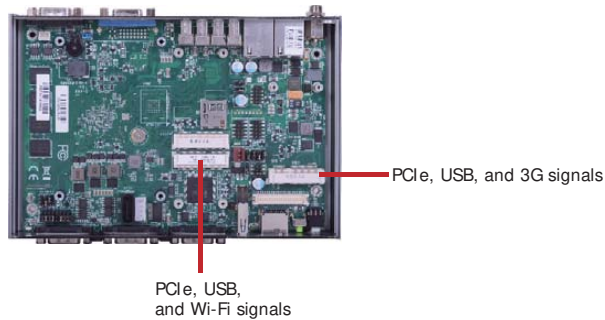

2. The system board is equipped with 2 Mini PCIe slots. The Mini PCIe slot supports full length and half length Mini PCIe card. Note the key on the slot. The key ensures the Mini PCIe card can be plugged into the slot in only one direction.

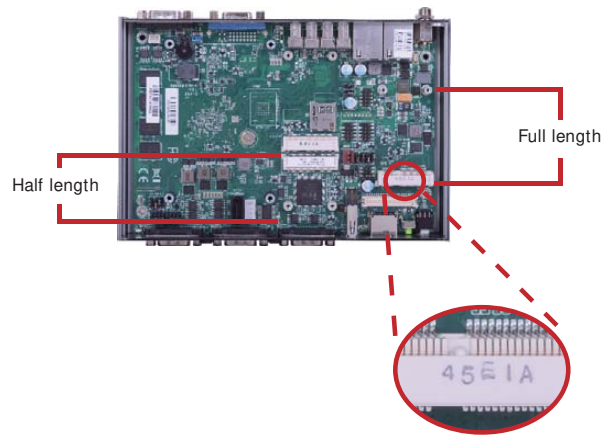

3. Grasping the Mini PCIe card by its edges, align the card into the slot at an approximately 30 degrees angle. Apply firm even pressure to each end of the card until it slips down into the slot. The contact fingers on the edge of the card will almost completely disappear inside the slot.

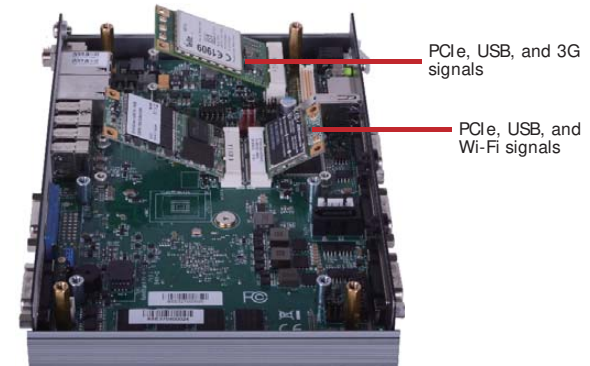

4. Push the Mini PCIe card down and use the provided mounting screws to secure the card on the system board.

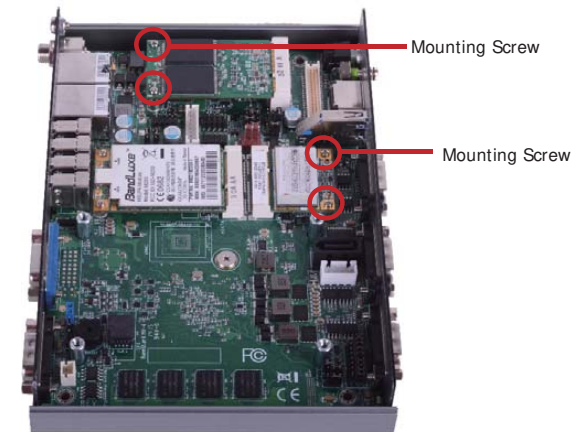

Chapter 3

Installing the mSATA Card

1. Locate the mSATA slot on the system board.

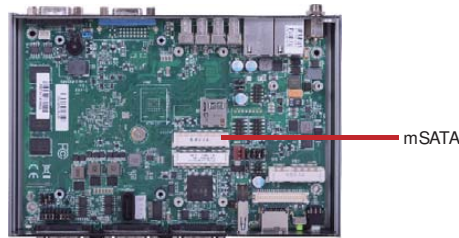

2. The system board is equipped with a mSATA slot. The mSATA slot supports full length mSATA card. Note the key on the slot. The key ensures the mSATA card can be plugged into the slot in only one direction.

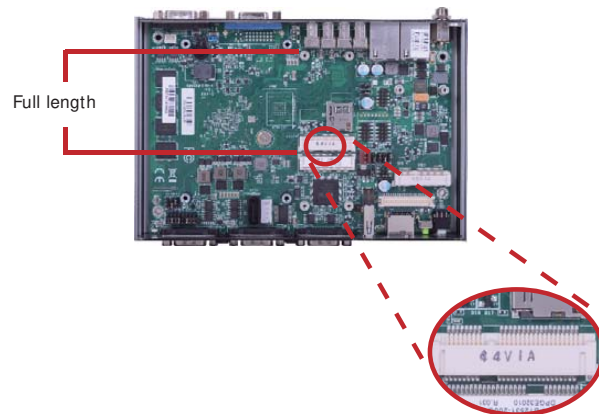

3. Grasping the mSATA card by its edges, align the card into the slot at an approximately 30 degrees angle. Apply firm even pressure to each end of the card until it slips down into the slot. The contact fingers on the edge of the card will almost completely disappear inside the slot.

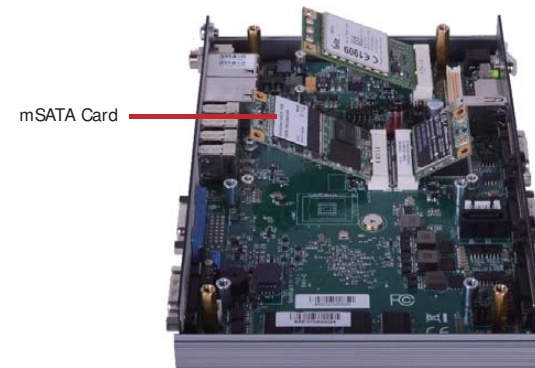

4. Push the mSATA card down and use the provided mounting screws to secure the card on the system board.

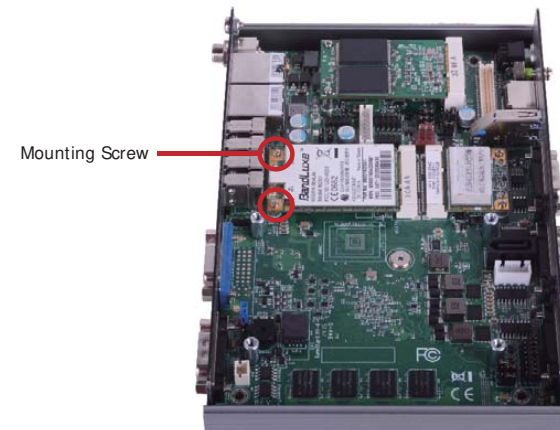

Chapter 4 - Jumper Settings

Clear CMOS Data

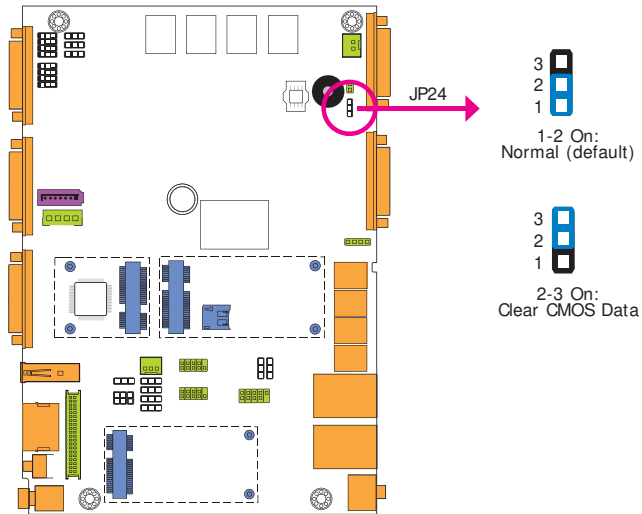

If you encounter the following,

- CMOS data becomes corrupted.
- You forgot the supervisor or user password.

you can reconfigure the system with the default values stored in the ROM BIOS.

To load the default values stored in the ROM BIOS, please follow the steps below.

- Power-off the system and unplug the power cord.
- Set JP24 pins 2 and 3 to On. Wait for a few seconds and set JP24 back to its default setting, pins 1 and 2 On.
- Now plug the power cord and power-on the system.

Auto Power-on Select

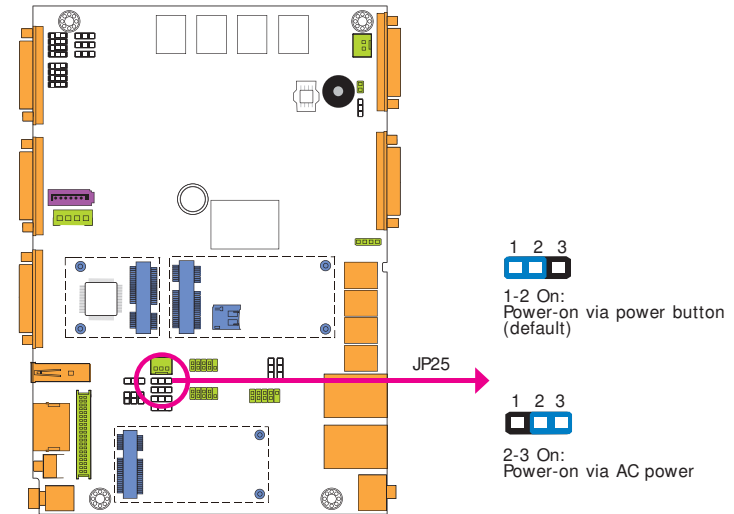

JP25 is used to select the method of powering on the system. If you want the system to power-on whenever AC power comes in, set JP25 pins 2 and 3 to On. If you want to use the power button, set pins 1 and 2 to On.

When using the JP25 "Power On" feature to power the system back on after a power failure occurs, the system may not power on if the power lost is resumed within 5 seconds (power flicker).

Chapter 4

USB Power Select

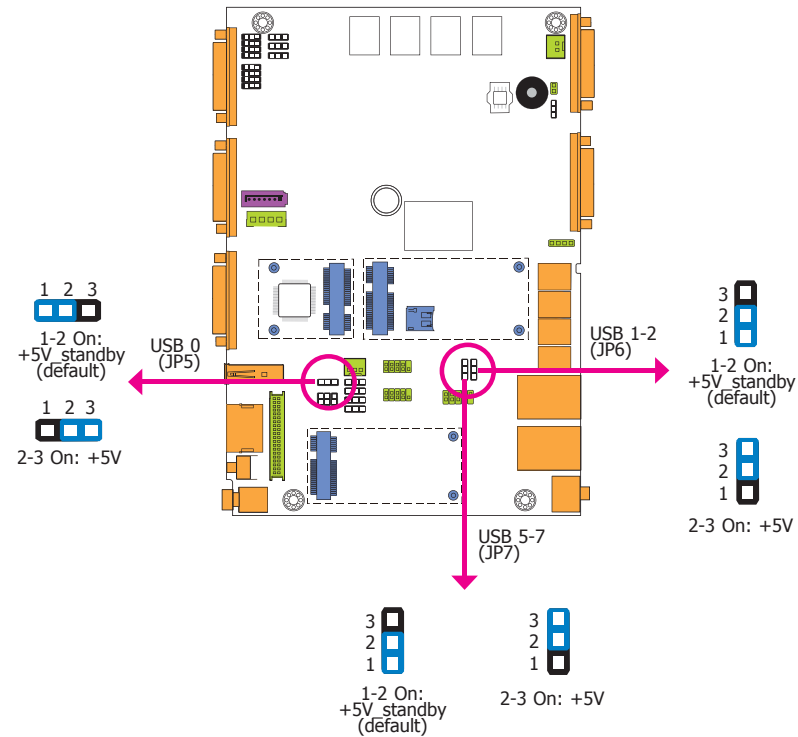

JP5, JP6 and JP7 are used to select the power of the USB ports. Selecting +5V_standby will allow you to use a USB device to wake up the system.



Important:

If you are using the Wake-On-USB Keyboard/Mouse function for 2 USB ports, the +5V_standby power source of your power supply must support $\geq 1.5A$. For 3 or more USB ports, the +5V_standby power source of your power supply must support $\geq 2A$.

Panel Power Select

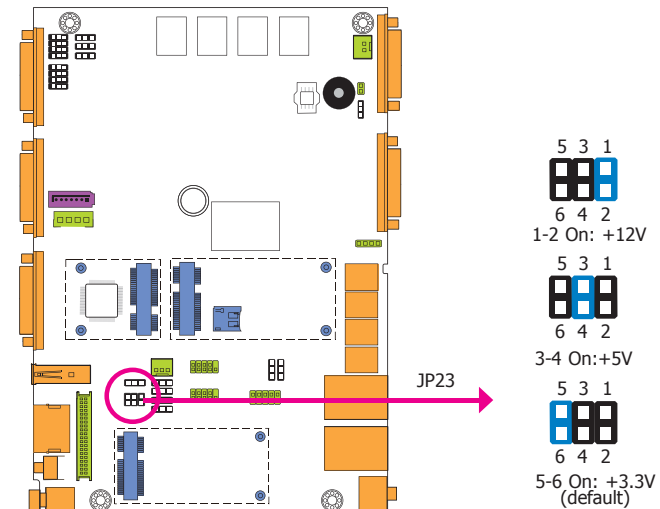

JP23 is used to select the power supplied with the LCD panel.



Important:

Before powering-on the system, make sure that the power settings of JP23 match the LCD panel's specification. Selecting the incorrect voltage will seriously damage the LCD panel.

Backlight Power Select

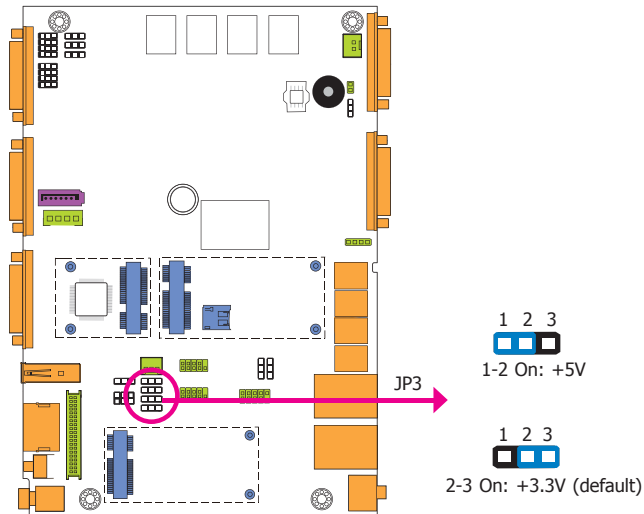

JP3 is used to select the power level of backlight brightness control: +5V or +3.3V.

Important: Before powering-on the system, make sure that the power settings of JP3 match the power specification of backlight control. Selecting the incorrect voltage will seriously damage the backlight.

Dimming Mode Select

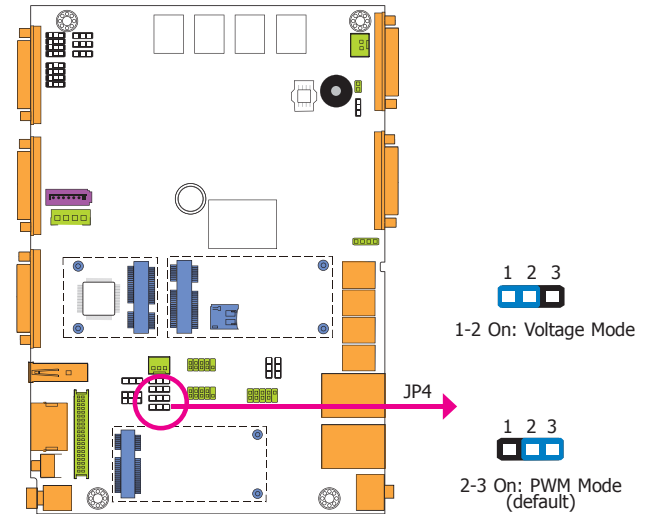

JP4 allows you to select the mode for the lightness control of the LVDS panel.

Important: You need to refer to your panel's user guide to determine the type of mode (PWM or Voltage) most appropriate for your panel.

Chapter 4

Digital I/ O Power Select

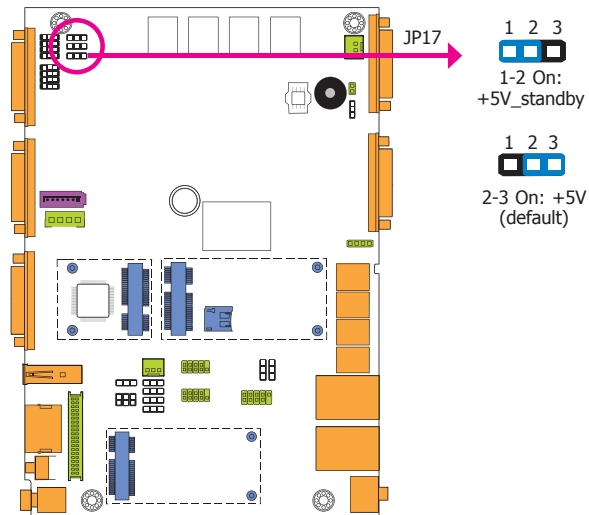

JP17 is used to select the power of DIO (Digital I/O) signal.

Digital I/ O Output State

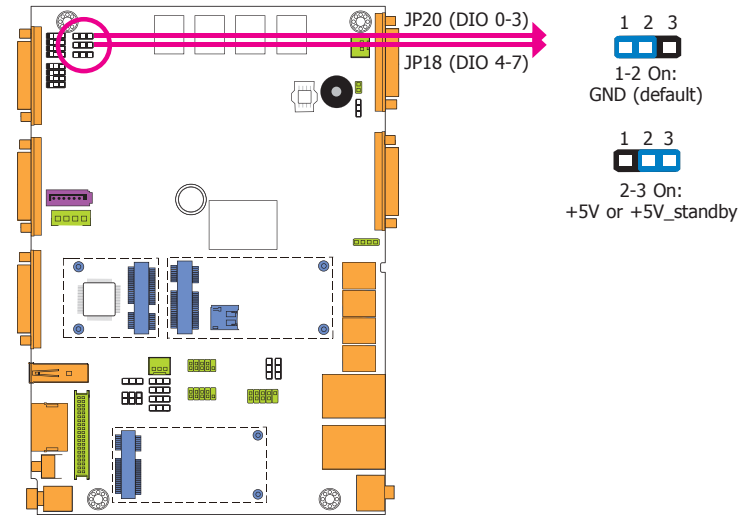

Based on the power level of DIO (Digital I/O) selected on JP17, JP20 (DIO pin 0-3) and JP18 (DIO pin 4-7) are used to select the state of DIO output: pull high or pull low. When selecting pull high, the power selection will be the same as JP17's setting.

Chapter 4

LCD / Inverter Power Select

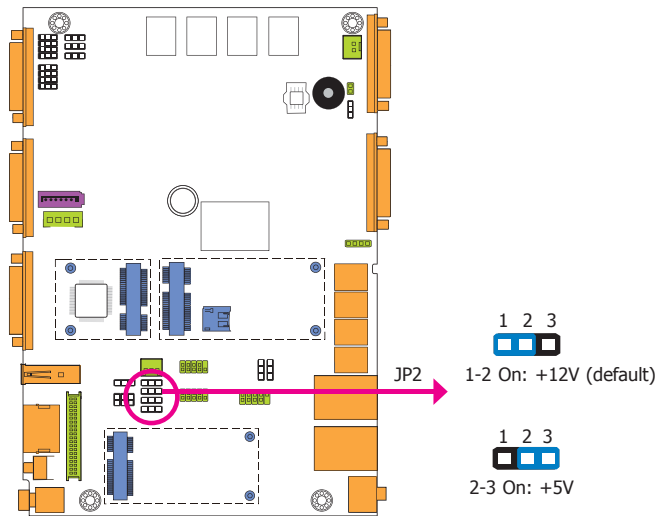

JP2 is used to select the power level of the LCD/inverter power connector.

COM 4 / DIO Select

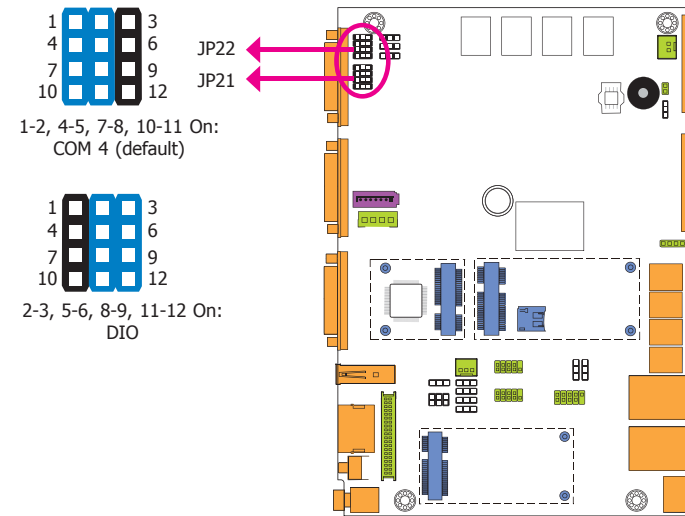

The system board uses JP21 and JP22 to select between RS232/422/485 COM 4 or isolated 8-bit DIO at the rear panel.



Note:
You cannot use COM 4 and DIO at the same time. Please set up JP21 and JP22 together.

Chapter 5 - Ports and Connectors

Front Panel I / O Ports

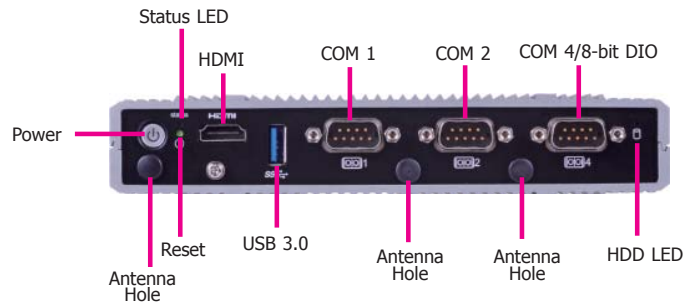

The front panel I/O ports consist of the following:

- 3 DB-9 serial ports
 - supports RS232/422/485
 - COM port 4 supports 8-bit DIO
- 1 USB 3.0 (Type A) port
- 1 HDMI port
- 3 Wi-Fi antenna holes
- 1 status LED
- 1 HDD LED
- 1 reset button
- 1 power button

Rear Panel I / O Ports

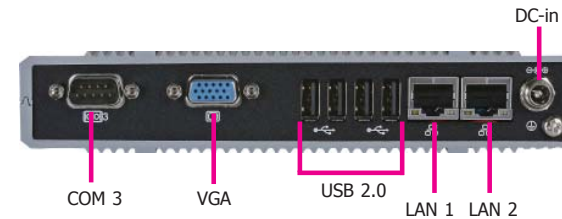

The rear panel I/O ports consist of the following:

- 1 9~36V DC-in jack
- 1 DB-9 serial port
- 1 VGA port
- 2 RJ45 LAN ports
- 4 USB 2.0 (Type A) ports

USB Ports

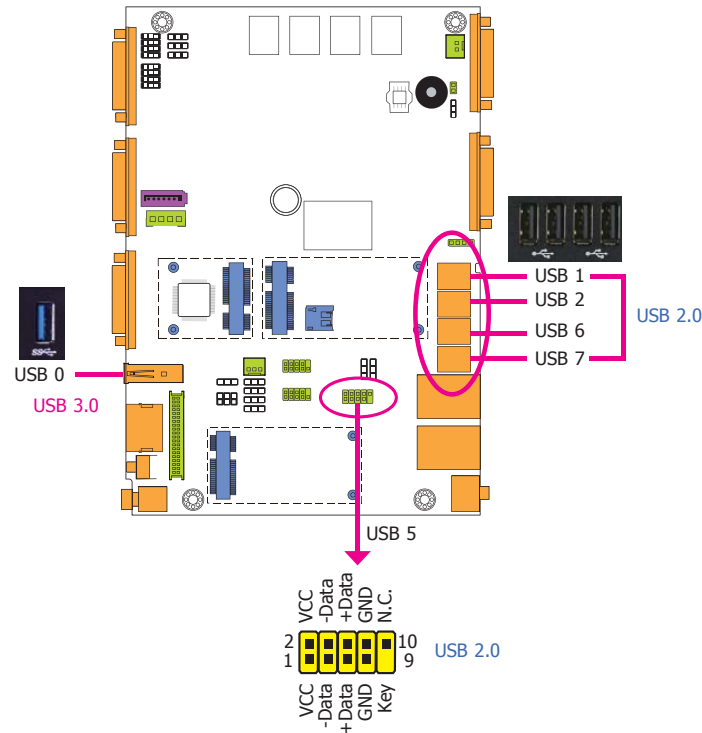

The USB device allows data exchange between your computer and a wide range of simultaneously accessible external Plug and Play peripherals.

The system board is equipped with one onboard USB 3.0 port (USB 0) and four onboard USB 2.0 ports (USB 1/2/6/7). The 10-pin connector allows you to connect 1 additional USB 2.0 port (USB 5). The additional USB port may be mounted on a card-edge bracket. Install the card-edge bracket to an available slot at the rear of the system chassis and then insert the USB port cables to a connector.

BIOS Setting

Configure the onboard USB in the Advanced menu ("USB Configuration" submenu) of the BIOS. Refer to chapter 7 for more information.

Driver Installation

You may need to install the proper drivers in your operating system to use the USB device. Refer to chapter 4 for more information.

Wake-On-USB Keyboard/ Mouse

The Wake-On-USB Keyboard/Mouse function allows you to use a USB keyboard or USB mouse to wake up a system from the S3 (STR - Suspend To RAM) state. To use this function:

Jumper Setting

JP5, JP6 and JP7 must be set to "1-2 On: +5V_standby". Refer to "USB Power Select" in this chapter for more information.



Important:

If you are using the Wake-On-USB Keyboard/Mouse function for 2 USB ports, the +5V_standby power source of your power supply must support $\geq 1.5A$. For 3 or more USB ports, the +5V_standby power source of your power supply must support $\geq 2A$.

Chapter 5

Important:
When installing Windows 7, only native USB 2.0 devices (USB port 0 to USB port 3) can operate under DOS mode. Please refer to the following tables for more information on the type of USB ports.

Table 1. OS Selection

Operation Environment for Customers	DOS	Windows 7	Windows 8.x	Linux
OS Selection in the BIOS Advanced Menu	Windows 8.x	Windows 7	Windows 8.x	Windows 8.x
Available USB ports	All	When installing Windows 7 first time, only native USB 2.0 ports can work. Please refer to the USB type in table 2 below.	All	All

Table 2. The Type of USB Ports

Model Name	BT253
USB 3.0	Native
USB 0	Native
USB 1	Native
USB 2	Native (share with USB 3.0 port)
USB 3	Native
USB 4	HSIC port 0
USB 5	HSIC port 1
USB 6	HSIC port 2
USB 7	HSIC port 3

COM (Serial) Ports

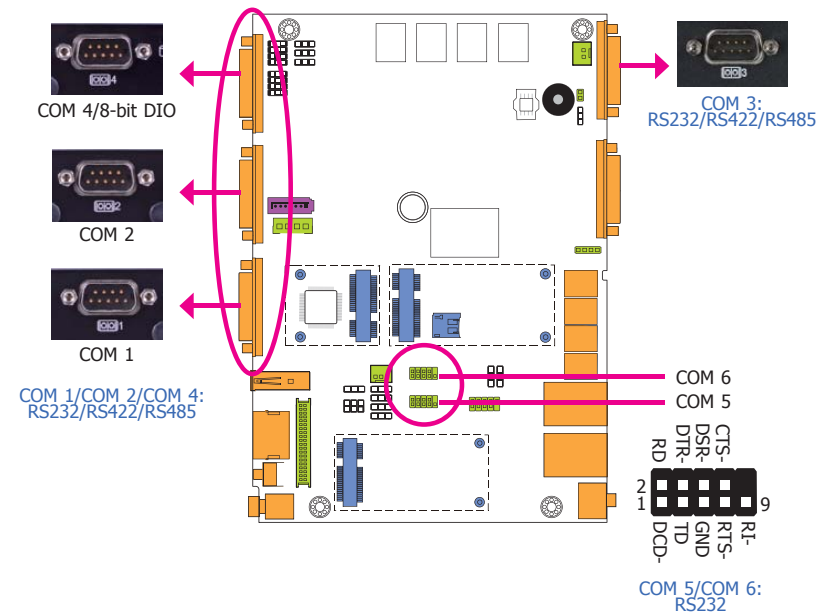

The serial ports are asynchronous communication ports with 16C550A-compatible UARTs that can be used with modems, serial printers, remote display terminals, and other serial devices.

BIOS Setting

Configure the serial ports in the Integrated Peripherals submenu ("Onboard I/O Chip Setup" section) of the BIOS. Refer to chapter 7 for more information.

Chapter 5

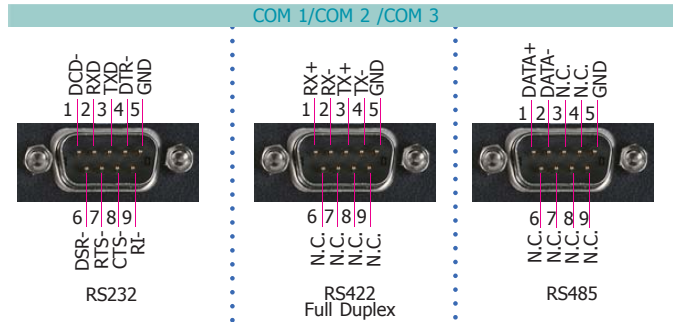

COM 4 (Serial) Port

This DB-9 serial port can be used as a RS232/422/485 COM port or as an isolated 8-bit DIO via the jumper setting. Refer to "COM 4/DIO Select" in this section for its respective configuration.

8-bit DIO (4-bit in and 4-bit out)

The 8-bit Digital I/O connector provides powering-on function to external devices that are connected to the connector.

Pins	COM 4 Function			DIO Function
	RS232	RS422	RS485	
1	DCD	RX+	DATA+	DIN0A
2	RX	RX-	DATA-	DIN0B
3	TX	TX+	NC	DIN1A
4	DTR	TX-	NC	DIN1B
5	GND	GND	GND	GND
6	DSR	NC	NC	DOUT0A
7	RTS	NC	NC	DOUT0B
8	CTS	NC	NC	DOUT1A
9	RI	NC	NC	DOUT1B

Graphics Interfaces

The display ports consist of the following:

- 1 HDMI port
- 1 VGA port

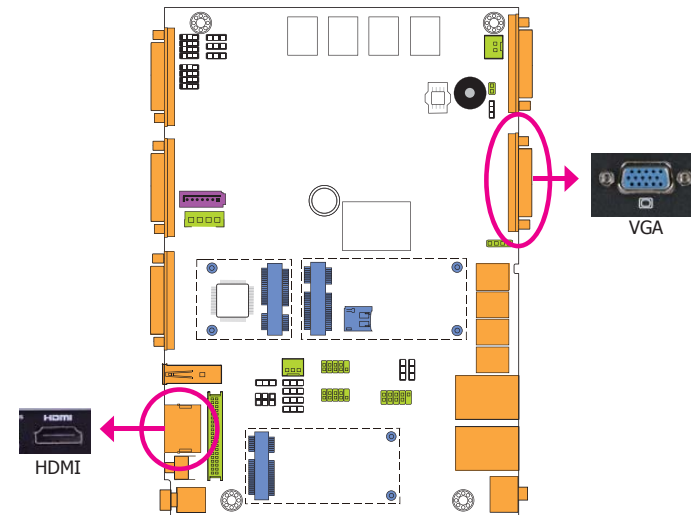

VGA Port

The VGA port is used for connecting a VGA monitor. Connect the monitor's 15-pin D-shell cable connector to the VGA port. After you plug the monitor's cable connector into the VGA port, gently tighten the cable screws to hold the connector in place.

HDMI Port

The HDMI port which carries both digital audio and video signals is used to connect a LCD monitor or digital TV that has the HDMI port.

BIOS Setting

Configure the display devices in the Chipset menu ("North Bridge Configuration" submenu) of the BIOS. Refer to the chapter 7 for more information.

Chapter 5

9~36V DC-in

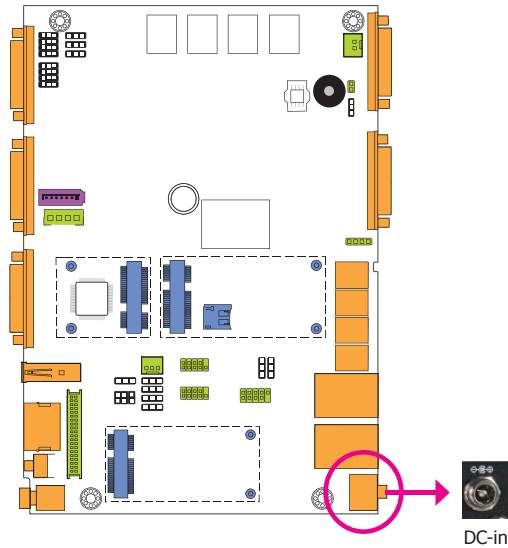

This jack provides maximum of 120W power and is considered a low power solution. Connect a DC power cord to this jack. Use a power adapter within 9~36V DC output voltage. (We only provide 19V DC output in the package contents.) Using a voltage out of the range 9~36V may fail to boot the system or cause damage to the system board.

RJ45 LAN Ports

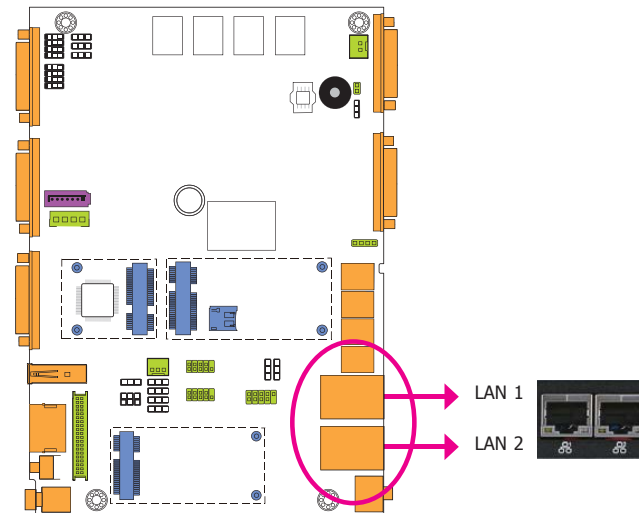

Features

- 2 Intel® I210 PCI Express Gigabit Ethernet controllers

The LAN ports allow the system board to connect to a local area network by means of a network hub.

BIOS Setting

Configure the onboard LAN in the Chipset menu ("South Bridge Configuration" submenu) of the BIOS. Refer to chapter 7 for more information.

Driver Installation

Install the LAN drivers. Refer to chapter 8 for more information.

I/ O Connectors

Serial ATA Connector

Serial ATA Power Connector

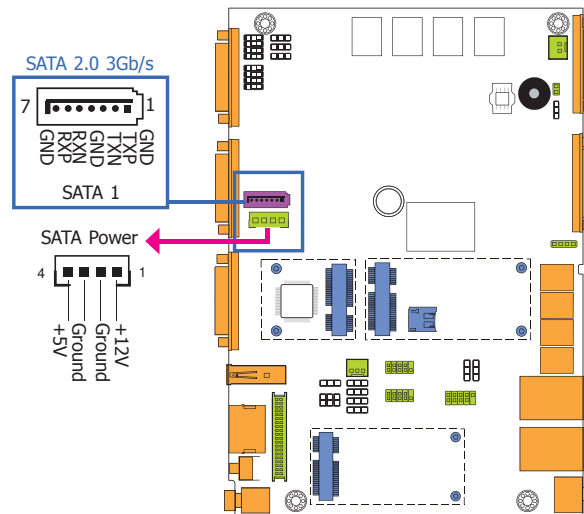

Features

- 1 Serial ATA 2.0 port with data transfer rate up to 3Gb/s
- Integrated Advanced Host Controller Interface (AHCI) controller

The Serial ATA connector is used to connect the Serial ATA device. Connect one end of the Serial ATA data cable to a SATA connector and the other end to your Serial ATA device.

The SATA power connector supplies power to the SATA drive. Connect one end of the provided power cable to the SATA power connector and the other end to your storage device.

BIOS Setting

Configure the Serial ATA drives in the Advanced menu ("IDE Configuration" submenu) of the BIOS. Refer to chapter 7 for more information.

Cooling Fan Connector

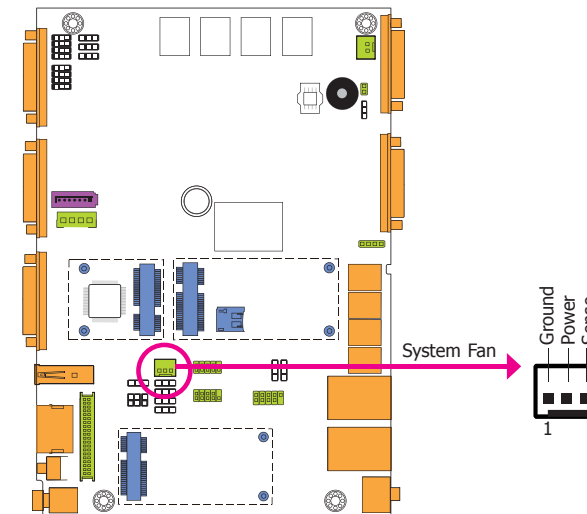

The fan connector is used to connect the cooling fan. The cooling fan will provide adequate airflow throughout the chassis to prevent overheating the CPU and system board components.

BIOS Setting

The Advanced menu ("Hardware Health Configuration" submenu) of the BIOS will display the current speed of the cooling fans. Refer to chapter 7 for more information.

LVDS LCD Panel with Power Connector

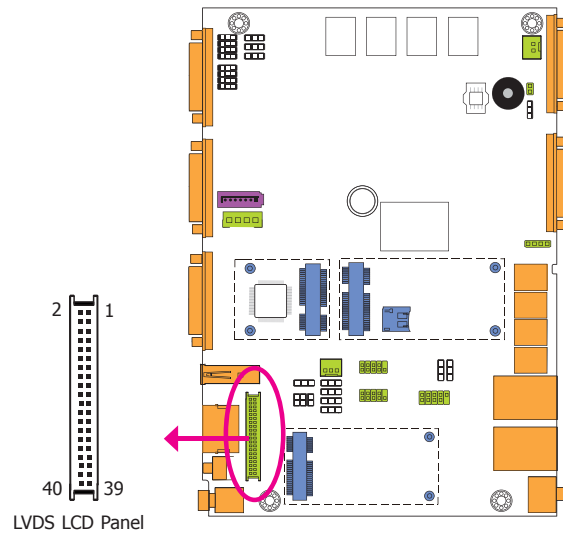

The system board allows you to connect a LCD Display Panel by means of the LVDS LCD panel connector and the LCD/Inverter power connector. These connectors transmit video signals and power from the system board to the LCD Display Panel.

Refer to the right side for the pin functions of the connector.

BIOS Setting

Configure the LCD panel in the Advanced/Chipset Features submenu of the BIOS. Refer to chapter 7 for more information.



Note:
DFI board's LVDS connector: Hirose DF13-40DP-1.25V(91)/40P/1.25mm; cable side connector: Hirose DF13-40DS-1.25C.

Pins	Function	Pins	Function
1	GND	2	GND
3	LVDSA_DATA3P	4	LVDSB_DATA3P
5	LVDSA_DATA3N	6	LVDSB_DATA3N
7	GND	8	GND
9	LVDSA_DATA2P	10	LVDSB_DATA2P
11	LVDSA_DATA2N	12	LVDSB_DATA2N
13	GND	14	GND
15	LVDSA_DATA1P	16	LVDSB_DATA1P
17	LVDSA_DATA1N	18	LVDSB_DATA1N
19	GND	20	GND
21	LVDSA_DATA0P	22	LVDSB_DATA0P
23	LVDSA_DATA0N	24	LVDSB_DATA0N
25	GND	26	GND
27	LVDSA_CLKP	28	LVDSA_CLKP
29	LVDSA_CLKN	30	LVDSA_CLKN
31	GND	32	GND
33	LVDS_DDC_CLK	34	Backlight_On_Off
35	LVDS_DDC_DATA	36	+3.3V
37	Backlight Power	38	Dimming
39	Backlight Power	40	Panel Power

Chapter 5

Mic-in Connector

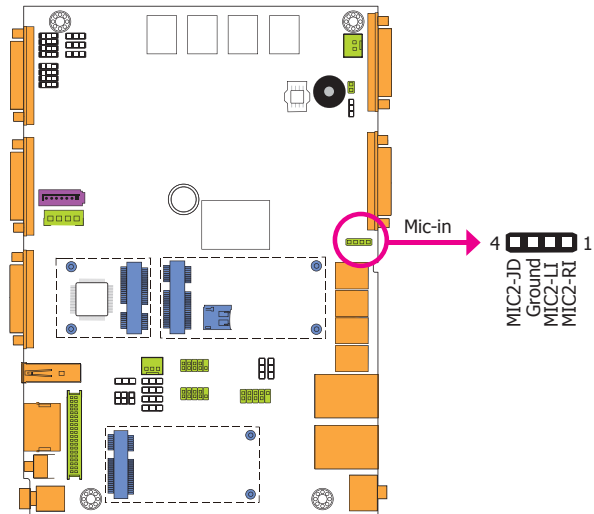

The mic-in connector is used to connect an external microphone.

Chassis Intrusion Connector

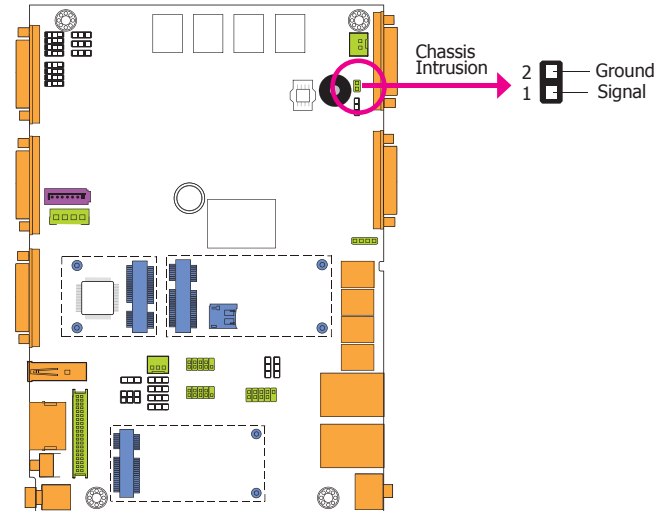

The board supports the chassis intrusion detection function. Connect the chassis intrusion sensor cable from the chassis to this connector. When the system's power is on and a chassis intrusion occurred, an alarm will sound. When the system's power is off and a chassis intrusion occurred, the alarm will sound only when the system restarts.

Expansion Slots

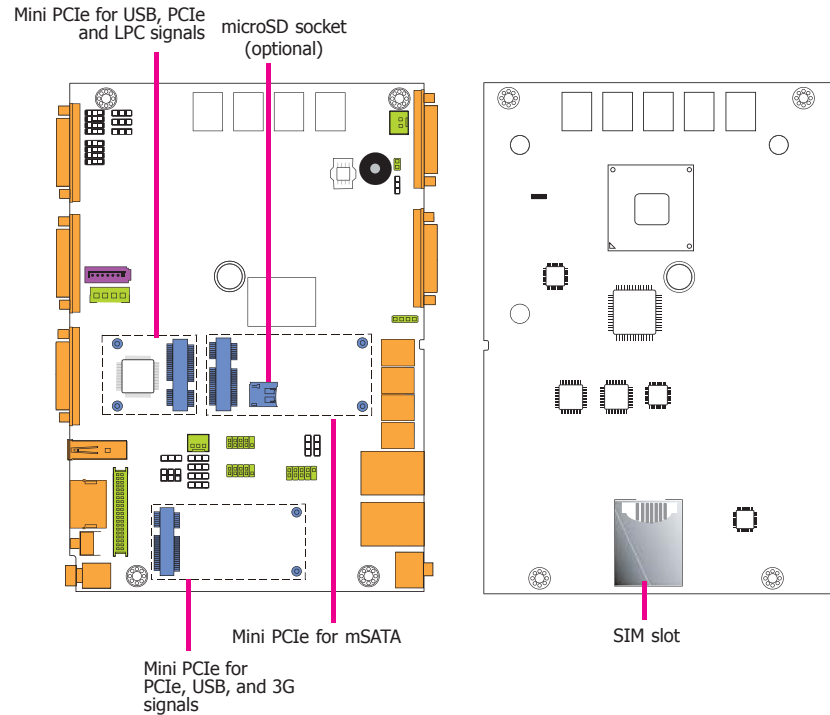

Standby Power LED

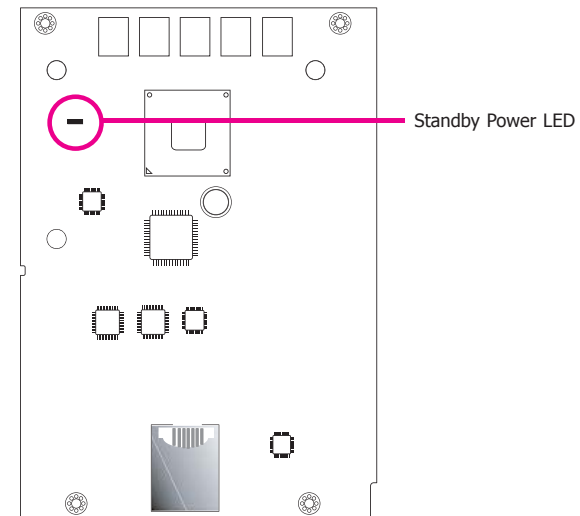

This LED will blink when the system is in the standby mode. It indicates that there is power on the system board. Power-off the PC and then unplug the power cord prior to installing any devices. Failure to do so will cause severe damage to the motherboard and components.

SIM Slot

The SIM slot on the system board is used to insert a SIM card.

Mini PCI Express Slots

The Mini PCI Express slots on the system board are used to install one half and/or full size Mini PCIe card such as network cards or other cards that comply to the mini PCI Express specifications into the mini PCI Express slot.

microSD Socket

The microSD socket allows you to install a microSD card for the expansion of available memory.

Battery

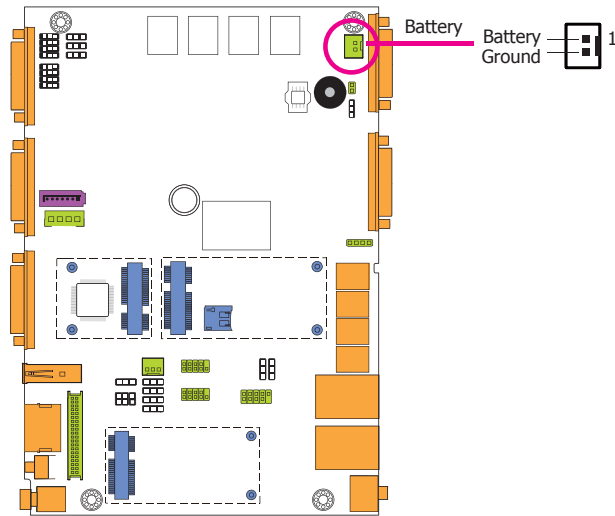

The lithium ion battery powers the real-time clock and CMOS memory. It is an auxiliary source of power when the main power is shut off.

Safety Measures

- Danger of explosion if battery incorrectly replaced.
- Replace only with the same or equivalent type recommend by the manufacturer.
- Dispose of used batteries according to local ordinance.

Chapter 6 - Mounting Options

Wall Mount

The wall mount kit includes the following:

- 2 Wall mount brackets
- Bracket screws

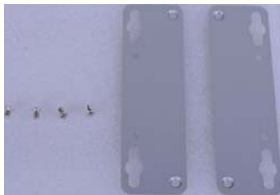

1. If the mounting screw has been previously attached at the top of the system, please remove them first.



2. At the top side of the system, use the provided mounting screws to secure the wallmount brackets on each side of the system.

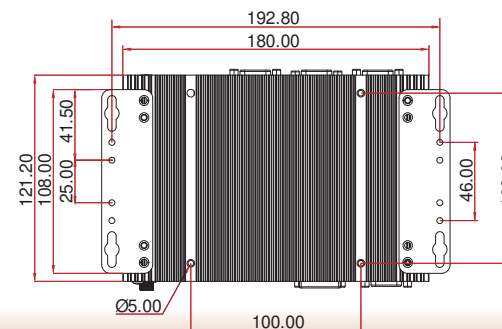
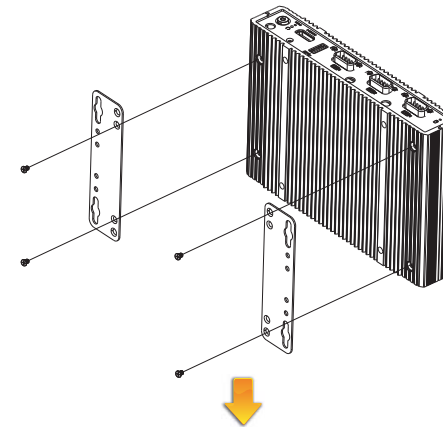

Chapter 6

VESA Mount

The vesa mount kit includes the following:

- 1 VESA mount bracket A
- 2 VESA mount bracket B
- Bracket screws

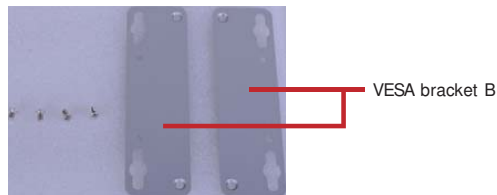
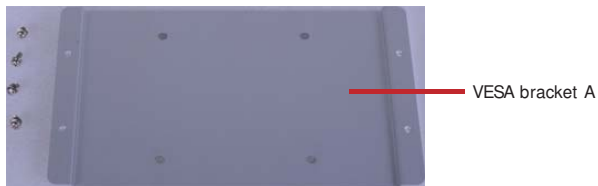

1. Prior to installing the VESA mount bracket A, make sure you have already installed the VESA mount bracket B.
2. Used the provided mounting screws to secure the VESA bracket A in place.

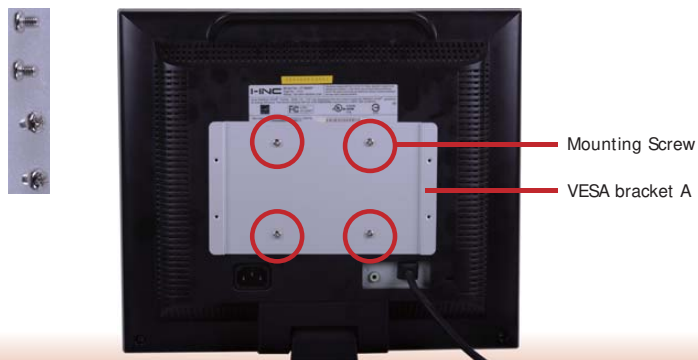

3. Align the VESA bracket A to the VESA bracket B and then use the provided mounting screws to secure the system in place.

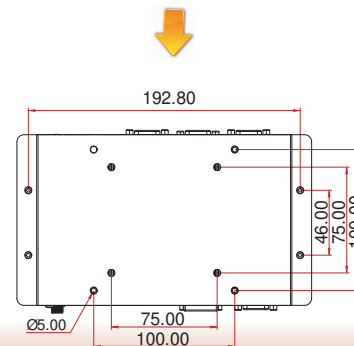
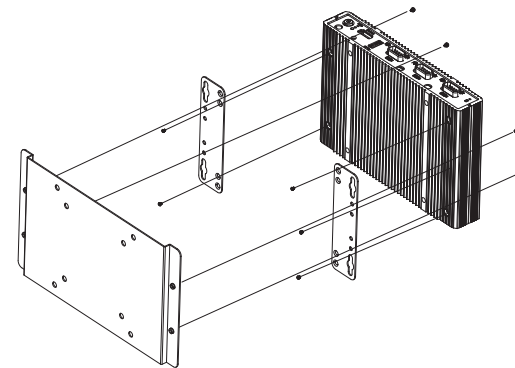
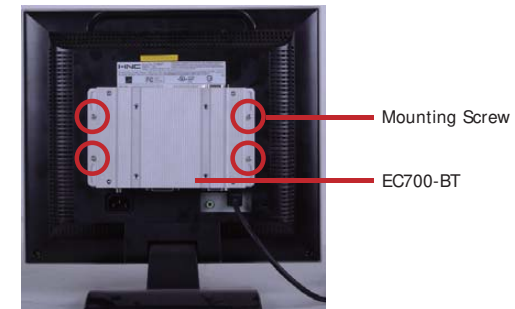

Chapter 6

DIN Rail Mount

The DIN Rail mount kit includes the following:

- 1 DIN Rail mount bracket
- 1 bracket
- Bracket screws



1. Turn the system to the top side and bottom side and locate the mounting screw. Remove these screws and then put them in a safe place for later use.



2. Align the mounting holes of the system and the mounting holes on the bracket, and then use the screws removed on step 1 to secure the bracket in place.



3. The 3 mounting holes on the bracket of the system is used to mount the DIN rail bracket.

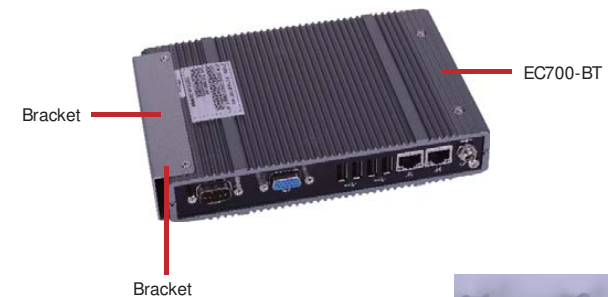

Chapter 6

4. Align the mounting holes of the bracket in the system and the mounting holes on the DIN rail bracket, and then use the provided mounting screws to secure the bracket in place.

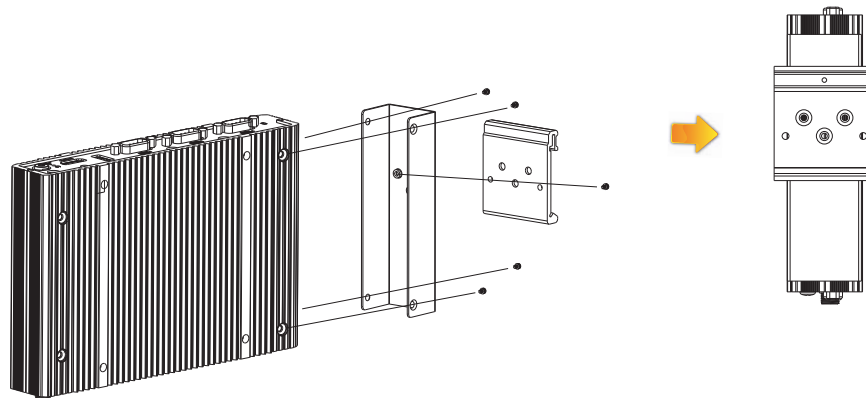
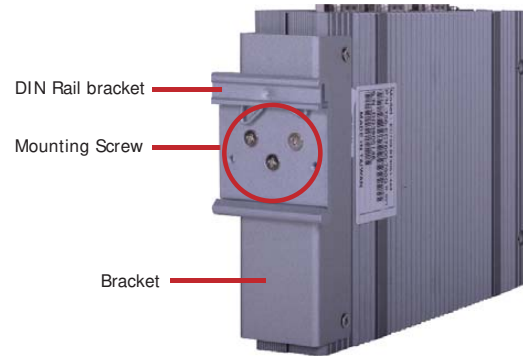

Chapter 7 - BIOS Setup

Overview

The BIOS is a program that takes care of the basic level of communication between the CPU and peripherals. It contains codes for various advanced features found in this system board. The BIOS allows you to configure the system and save the configuration in a battery-backed CMOS so that the data retains even when the power is off. In general, the information stored in the CMOS RAM of the EEPROM will stay unchanged unless a configuration change has been made such as a hard drive replaced or a device added.

It is possible that the CMOS battery will fail causing CMOS data loss. If this happens, you need to install a new CMOS battery and reconfigure the BIOS settings.



Note:

The BIOS is constantly updated to improve the performance of the system board; therefore the BIOS screens in this chapter may not appear the same as the actual one. These screens are for reference purpose only.

Default Configuration

Most of the configuration settings are either predefined according to the Load Optimal Defaults settings which are stored in the BIOS or are automatically detected and configured without requiring any actions. There are a few settings that you may need to change depending on your system configuration.

Entering the BIOS Setup Utility

The BIOS Setup Utility can only be operated from the keyboard and all commands are keyboard commands. The commands are available at the right side of each setup screen.

The BIOS Setup Utility does not require an operating system to run. After you power up the system, the BIOS message appears on the screen and the memory count begins. After the memory test, the message "Press DEL to run setup" will appear on the screen. If the message disappears before you respond, restart the system or press the "Reset" button. You may also restart the system by pressing the <Ctrl> <Alt> and keys simultaneously.

Legends

Keys	Function
Right and Left arrows	Moves the highlight left or right to select a menu.
Up and Down arrows	Moves the highlight up or down between submenu or fields.
< Esc >	Exit to the BIOS Setup Utility.
+ (plus key)	Scrolls forward through the values or options of the highlighted field.
- (minus key)	Scrolls backward through the values or options of the highlighted field.
Tab	Select a field.
< F1 >	Displays general help
< F2 >	Pervious values
< F4 >	Saves and resets the setup program.
< Enter >	Press <Enter> to enter the highlighted submenu.

Scroll Bar

When a scroll bar appears to the right of the setup screen, it indicates that there are more available fields not shown on the screen. Use the up and down arrow keys to scroll through all the available fields.

Submenu

When "►" appears on the left of a particular field, it indicates that a submenu which contains additional options are available for that field. To display the submenu, move the highlight to that field and press <Enter> .

AMI BIOS Setup Utility

Main

The Main menu is the first screen that you will see when you enter the BIOS Setup Utility.

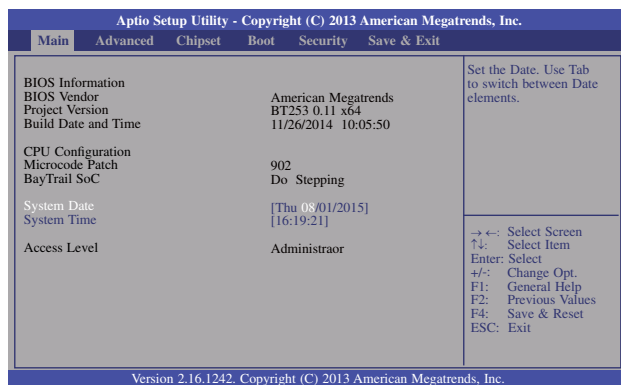

System Date

The date format is <day>, <month>, <date>, <year>. Day displays a day, from Sunday to Saturday. Month displays the month, from January to December. Date displays the date, from 1 to 31. Year displays the year, from 1980 to 2099.

System Time

The time format is <hour>, <minute>, <second>. The time is based on the 24-hour military-time clock. For example, 1 p.m. is 13:00:00. Hour displays hours from 00 to 23. Minute displays minutes from 00 to 59. Second displays seconds from 00 to 59.

Advanced

The Advanced menu allows you to configure your system for basic operation. Some entries are defaults required by the system board, while others, if enabled, will improve the performance of your system or let you set some features according to your preference.



Important:
Setting incorrect field values may cause the system to malfunction.

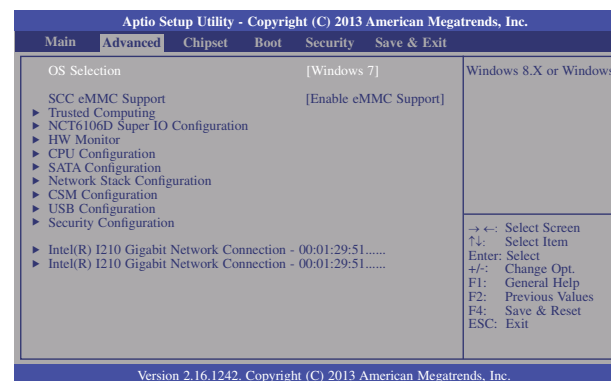

OS Selection

Select the OS support: Windows 8.X or Windows 7.

SCC eMMC Support

Enable or disable the SCC eMMC support.

Chapter 7

Trusted Computing

This section configures settings relevant to Trusted Computing innovations.

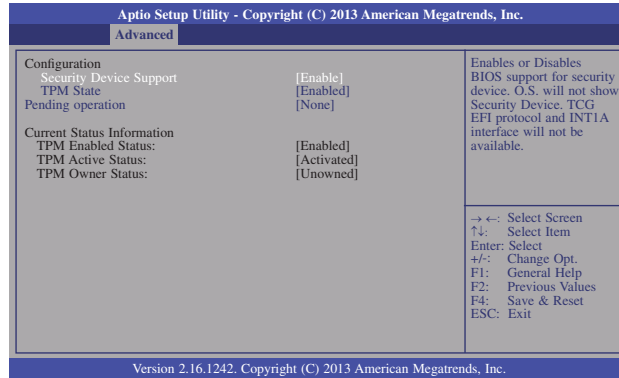

Security Device Support

This field is used to enable or disable BIOS supporting for the security device. O.S will not show the security device. TCG EFI protocol and INT1A interface will not be available.

TPM State

This field is used to enable or disable the security device.

Pending operation

This field is used to schedule an operation for the security device.

Note: Your computer will reboot during restart in order to change the device status.

NCT6106D Super IO Configuration

This section is used to configure the parameters of the system super IO chip.

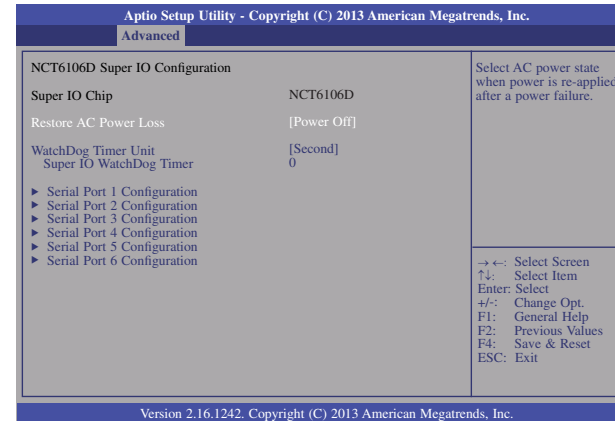

Restore AC Power Loss

Power Off

When power returns after an AC power failure, the system's power is off. You must press the Power button to power-on the system.

Power On

When power returns after an AC power failure, the system will automatically power-on.

WatchDog Timer Unit

Selects the WatchDog Timer Unit: second or minute.

Super IO WatchDog Timer

Enter the value to set the Super IO WatchDog timer. 0 means disabled.

Chapter 7

Serial Port 1 Configuration to Serial Port 6 Configuration

Sets the parameters of serial port 1 (COM A) and serial port 6 (COM F).

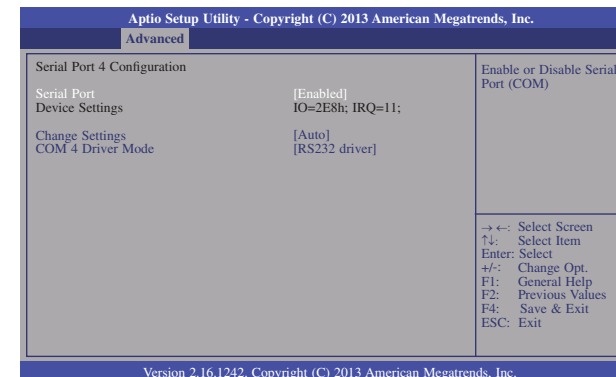
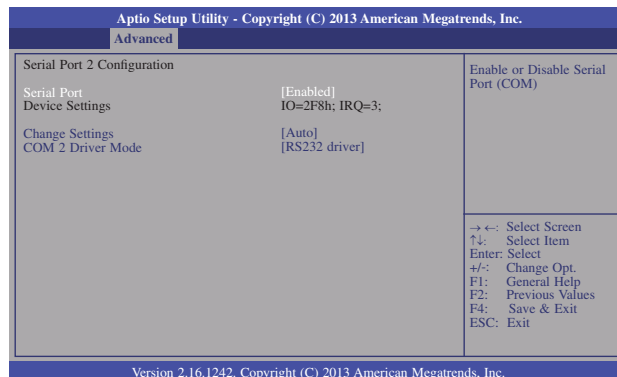
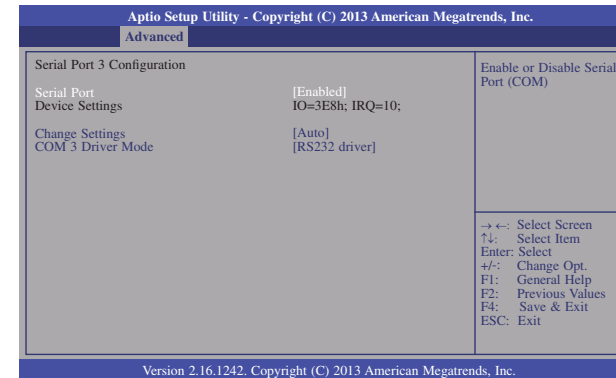
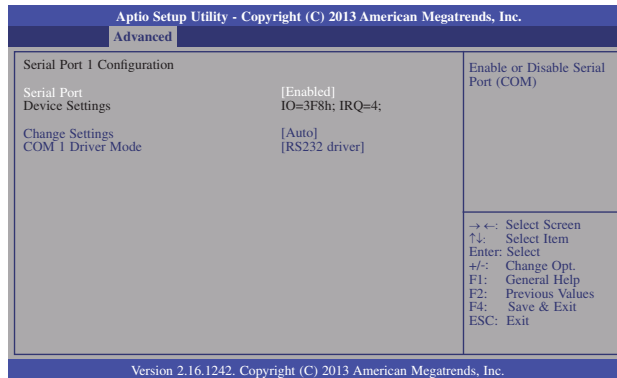

Chapter 7

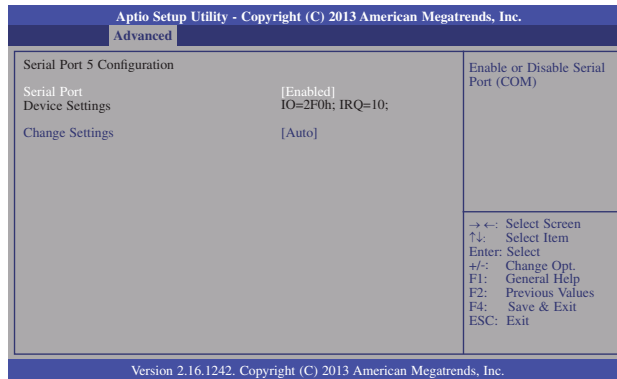

Serial Port

Enable or disable the serial COM port.

Change Settings

Select the IO/IRQ settings for the super I/O device.

COM Driver Mode

Select an optimal settings for the super I/O device.

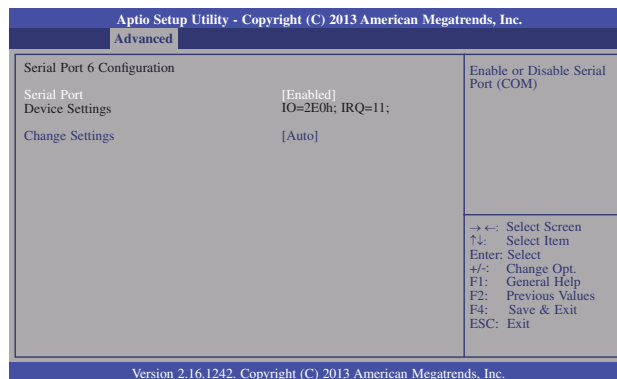

Chapter 7

HW Monitor

This section is used to monitor the hardware status.

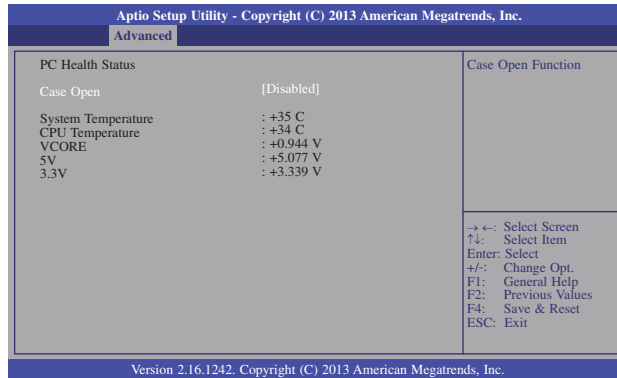

Case Open

Set this field to Enabled to allow the system to alert you of a chassis intrusion event.

CPU Configuration

This section is used to configure the CPU. It will also display the detected CPU information.

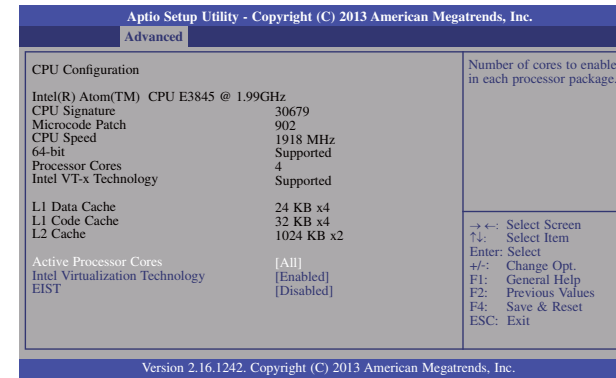

Active Processor Cores

Number of cores to enable in each processor package.

Intel Virtualization Technology

When this field is set to Enabled, the VMM can utilize the additional hardware capabilities provided by Vanderpool Technology.

EIST

This field is used to enable or disable the Intel Enhanced SpeedStep Technology.

Chapter 7

SATA Configuration

This section is used to enable or disable SATA devices.

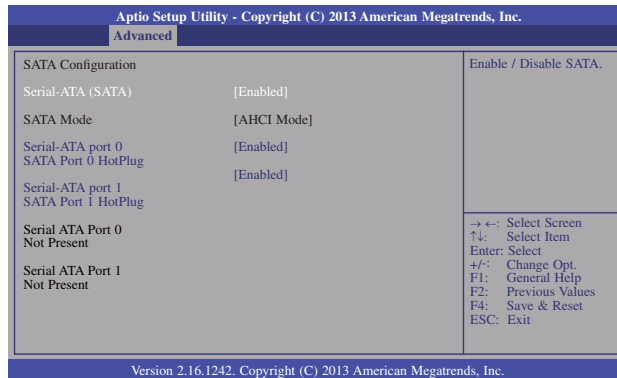

Serial-ATA (SATA)

This field is used to enable or disable Serial ATA devices.

Serial-ATA port 0 and port 1

Enable or disable Serial ATA port 0 and port 1.

Serial-ATA port 0 and port 1 HotPlug

Enable or disable Serial ATA port 0 and port 1 hotplug.

Network Stack Configuration

This section is used to enable or disable network stack settings.

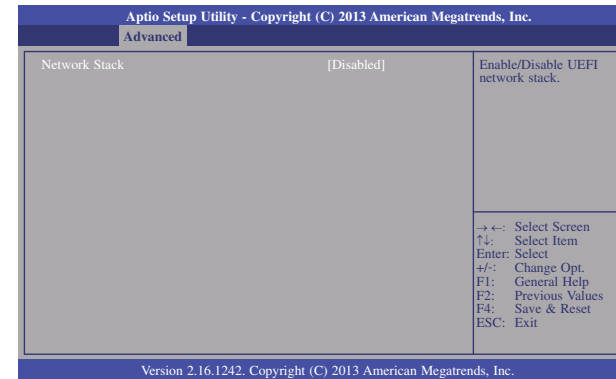

When Network Stack is set to enabled, it will display the following information:

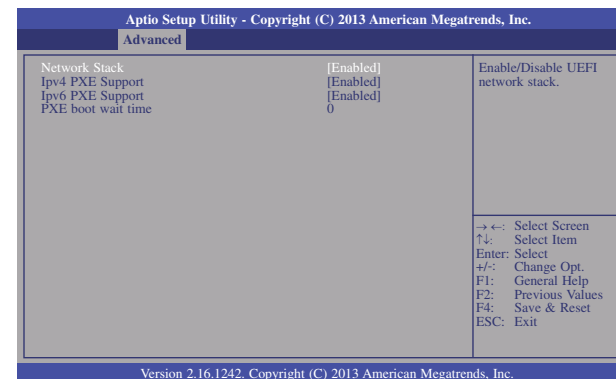

Chapter 7

Ipv4 PXE Support

When enabled, Ipv4 PXE boot supports. When disabled, Ipv4 PXE boot option will not be created.

Ipv6 PXE Support

When enabled, Ipv6 PXE boot supports. When disabled, Ipv6 PXE boot option will not be created.

PXE boot wait time

Enter the wait time value to abort the PXE boot.

CSM Configuration

This section configures the CSM settings.

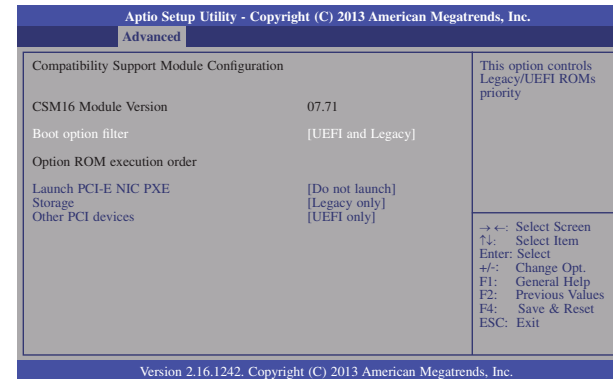

Boot option filter

This option controls Legacy/UEFI ROMs priority.

Launch PCI-E NIC PXE

This field controls the execution of PXE OpROM.

Storage

This field controls the execution of UEFI and Legacy Storage OpROM.

Other PCI devices

This field determines OpROM execution policy for devices other than network, storage or video.

Chapter 7

USB Configuration

This section is used to configure the parameters of USB device.

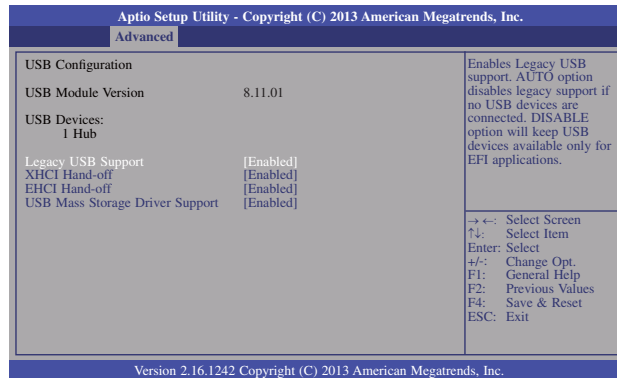

Legacy USB Support

Enabled

Enable legacy USB.

Disabled

Keep USB devices available only for EFI applications.

Auto

Disable support for legacy when no USB devices are connected.

XHCI Hand-off

This is a workaround for OSES without the XHCI hand-off support. The change of XHCI ownership should be claimed by the EHCI driver.

EHCI Hand-off

This is a workaround for OSES without the EHCI hand-off support. The change of EHCI ownership should be claimed by the EHCI driver.

USB Mass Storage Driver Support

Enable or disable the support of the USB Mass Storage Driver.

Important: When installing Windows 7, only native USB 2.0 devices (USB port 0 to USB port 3) can operate under DOS mode. Please refer to the following tables for more information on the type of USB ports.

Table 1. OS Selection

Operation Environment for Customers	DOS	Windows 7	Windows 8.x	Linux
OS Selection in the BIOS Advanced Menu	Windows 8.x	Windows 7	Windows 8.x	Windows 8.x
Available USB ports	All	When installing Windows 7 first time, only native USB 2.0 ports can work. Please refer to the USB type in table 2 below.	All	All

Table 2. The Type of USB Ports

Model Name	BT253
USB 3.0	Native
USB 0	Native
USB 1	Native
USB 2	Native (share with USB 3.0 port)
USB 3	Native
USB 4	HSIC port 0
USB 5	HSIC port 1
USB 6	HSIC port 2
USB 7	HSIC port 3

Chapter 7

Security Configuration

This section only displays the setting relevant to the Intel(R) Anti-Theft Technology.

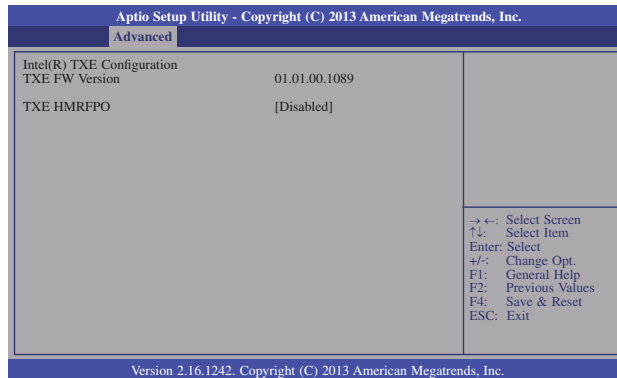

Intel(R) 1210 Gigabit Network Connection - 00:01:29:51...

This section is used to configure the parameters of Gigabit Ethernet device.

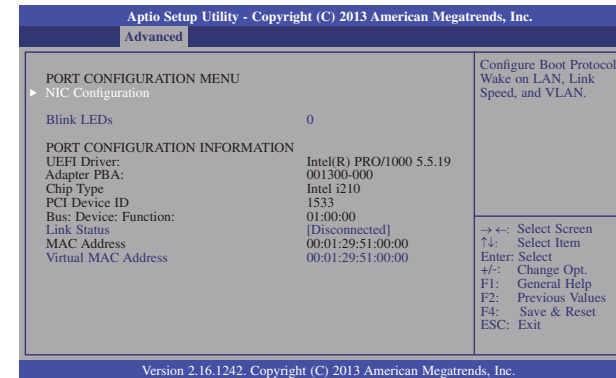

Blink LEDs

Identify the physical network port by blinking the associated LED.

Link Status

This field indicates the link status of the network device.

Virtual MAC Address

This field indicates programmatically assignable MAC address for the network port.

Chapter 7

NIC Configuration

This field is used to configure the network device.

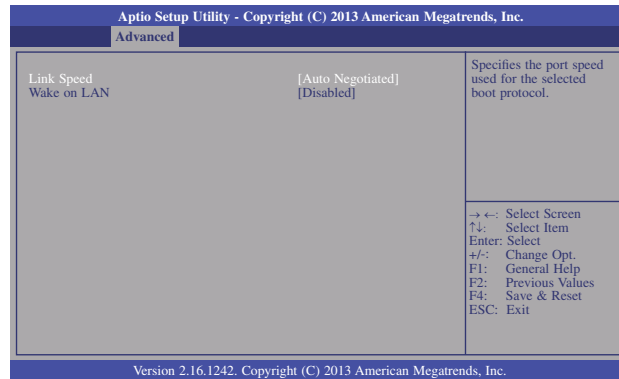

Link Speed

Specify the port speed which is used for the selected boot protocol.

Wake on LAN

Enable the server to be powered on using an in-band magic packet.

Intel(R) 1210 Gigabit Network Connection - 00:01:29:51...

This section is used to configure the parameters of Gigabit Ethernet device.

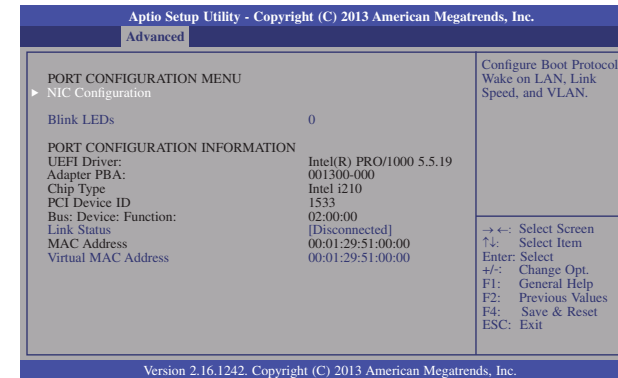

Blink LEDs

Identify the physical network port by blinking the associated LED.

Link Status

This field indicates the link status of the network device.

Virtual MAC Address

This field indicates programmatically assignable MAC address for the network port.

Chapter 7

NIC Configuration

This field is used to configure the network device.

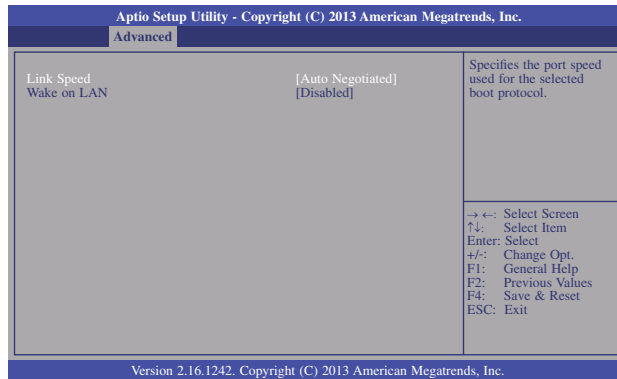

Link Speed

Specify the port speed which is used for the selected boot protocol.

Wake on LAN

Enable the server to be powered on using an in-band magic packet.

Chipset

This section configures relevant chipset functions.

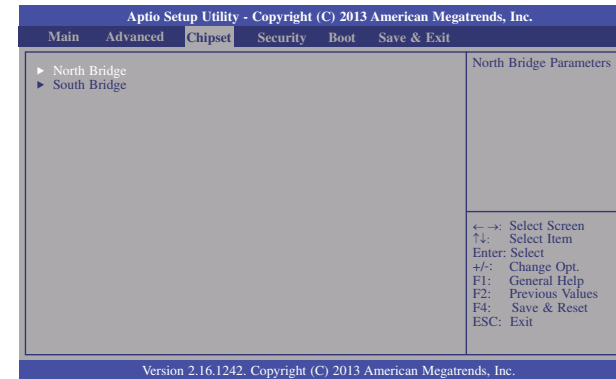

Chapter 7

North Bridge

This section configures the North bridge parameters.

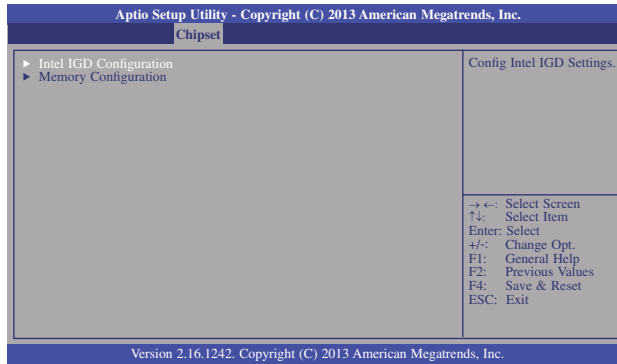

Intel IGD Configuration

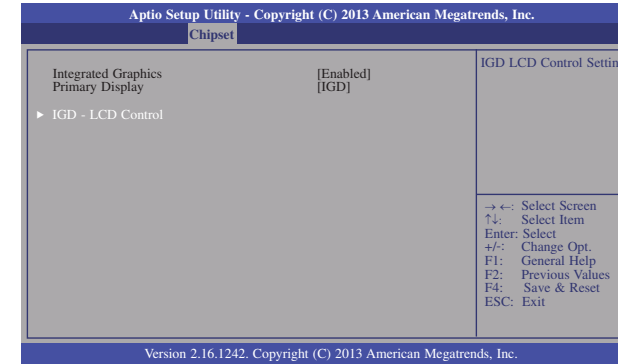

IGD - LCD Control

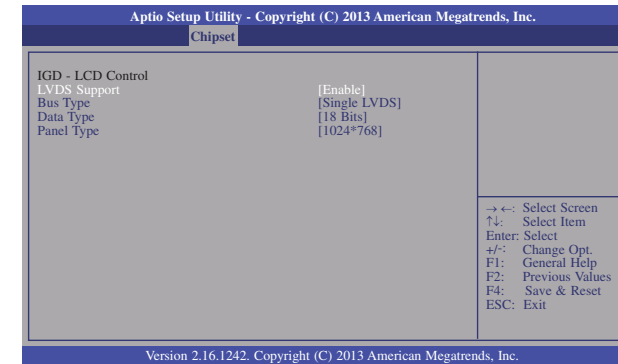

Chapter 7

Bus Type

Select the bus type for the flat panel: single LVDS or dual LVDS.

Data Type

Select the data type for the flat panel: 18-bits, 24-bits (VESA) or 24-bits (JEIDA).

Panel Type

Select the panel type for the flat panel.

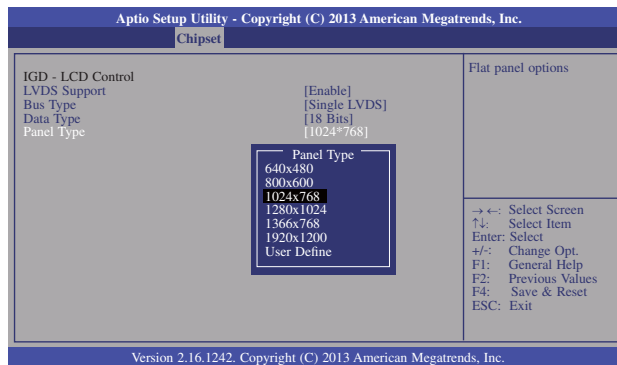

Memory Configuration

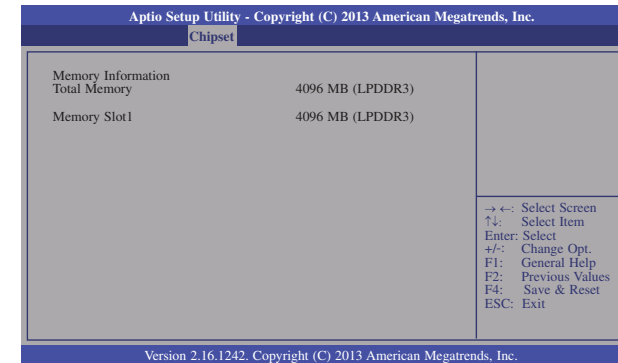

Chapter 7

South Bridge

This field is used to configure the parameters of the South Bridge.

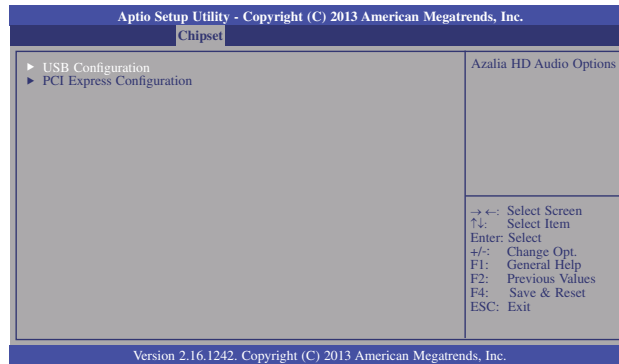

USB Configuration

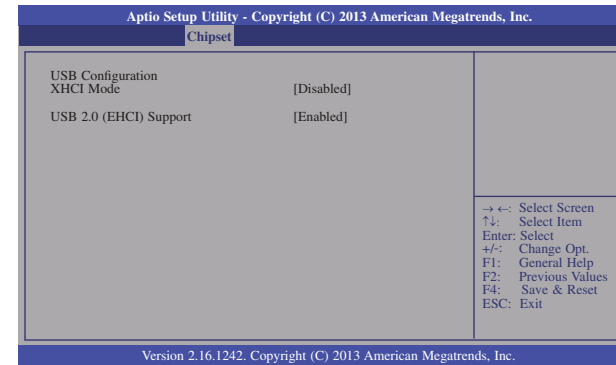

Chapter 7

PCI Express Configuration

This section configures settings relevant to PCI Express devices.

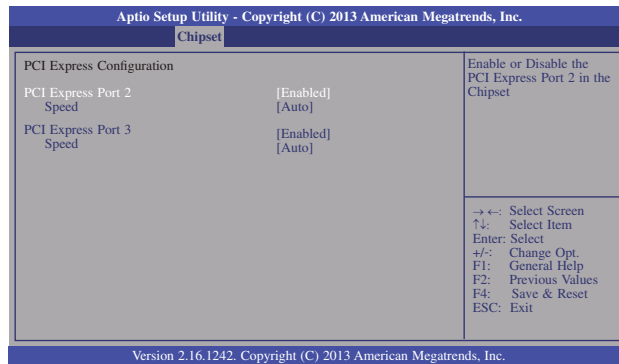

PCI Express Port 2-3

Enable or disable the PCI Express port in the chipset.

Speed

Select the speed for the PCI Express devices. The options are Auto, Gen1 or Gen2.

Security

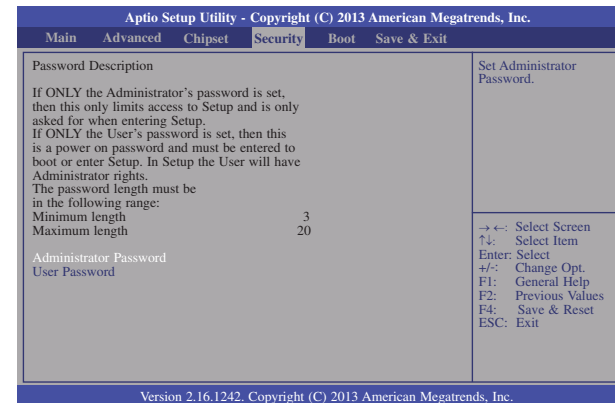

Administrator Password

Set the administrator password.

User Password

Set the user password.

Chapter 7

Boot

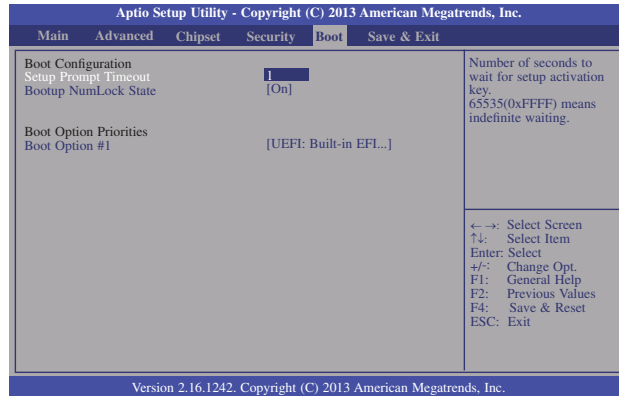

Setup Prompt Timeout

Select the number of seconds to wait for the setup activation key. 65535(0xFFFF) denotes indefinite waiting.

Bootup NumLock State

This allows you to determine the default state of the numeric keypad. By default, the system boots up with NumLock on wherein the function of the numeric keypad is the number keys. When set to Off, the function of the numeric keypad is the arrow keys.

Boot Option # 1

Select the system boot order.

Save & Exit

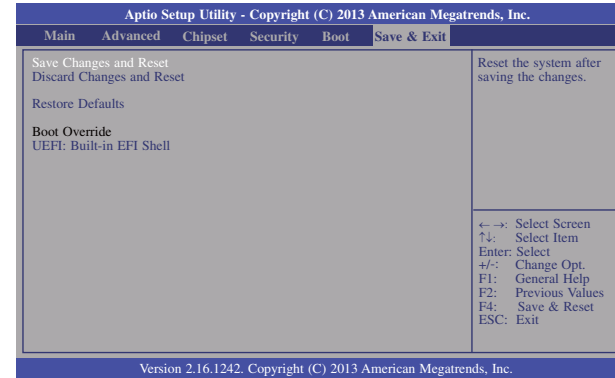

Save Changes and Reset

To save the changes, select this field and then press <Enter> . A dialog box will appear. Select Yes to reset the system after saving all changes made.

Discard Changes and Reset

To discard the changes, select this field and then press <Enter> . A dialog box will appear. Select Yes to reset the system setup without saving any changes.

Restore Defaults

To restore and load the optimized default values, select this field and then press <Enter> . A dialog box will appear. Select Yes to restore the default values of all the setup options.

Updating the BIOS

To update the BIOS, you will need the new BIOS file and a flash utility, AFUDOS.EXE. Please contact technical support or your sales representative for the files.

To execute the utility, type:

A:;> AFUDOS BIOS_File_Name /b /p /n

then press <Enter> .

```
C:\AFU\AFUDOS>afudos filename /B /P /N
-----
          AMI Firmware Update Utility(APTIO) v2.25
          Copyright (C)2008 American Megatrends Inc. All Rights Reserved.
-----
Reading file ..... done
Erasing flash ..... done
Writing flash ..... done
Verifying flash ..... done
Erasing BootBlock ..... done
Writing BootBlock ..... done
Verifying BootBlock ..... done

C:\AFU\AFUDOS>
```

Notice: BIOS SPI ROM

1. The Intel® Management Engine has already been integrated into this system board. Due to the safety concerns, the BIOS (SPI ROM) chip cannot be removed from this system board and used on another system board of the same model.
2. The BIOS (SPI ROM) on this system board must be the original equipment from the factory and cannot be used to replace one which has been utilized on other system boards.
3. If you do not follow the methods above, the Intel® Management Engine will not be updated and will cease to be effective.



Note:

- a. You can take advantage of flash tools to update the default configuration of the BIOS (SPI ROM) to the latest version anytime.
- b. When the BIOS IC needs to be replaced, you have to populate it properly onto the system board after the EEPROM programmer has been burned and follow the technical person's instructions to confirm that the MAC address should be burned or not.

Chapter 8 - Supported Software

The CD that came with the system board contains drivers, utilities and software applications required to enhance the performance of the system board.

Insert the CD into a CD-ROM drive. The autorun screen (Mainboard Utility CD) will appear. If after inserting the CD, "Autorun" did not automatically start (which is, the Mainboard Utility CD screen did not appear), please go directly to the root directory of the CD and double-click "Setup".

Auto Run Page (For Windows 8.1)

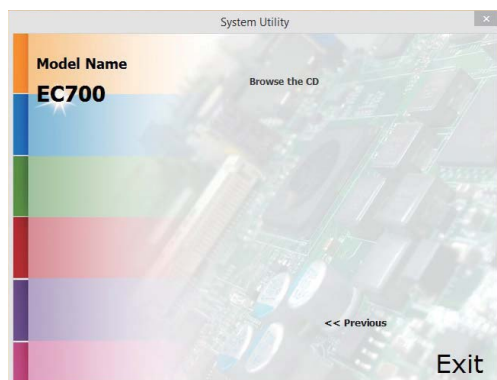
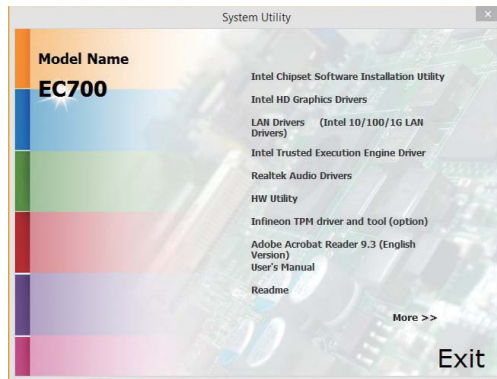

Auto Run Page (For Windows 7)

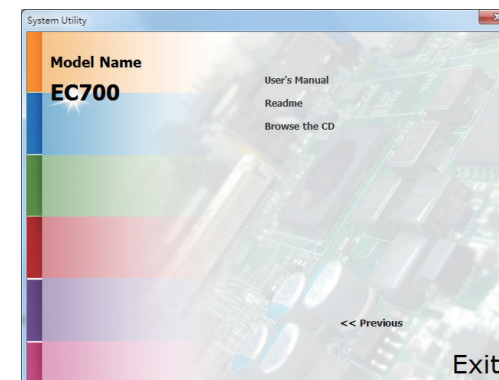
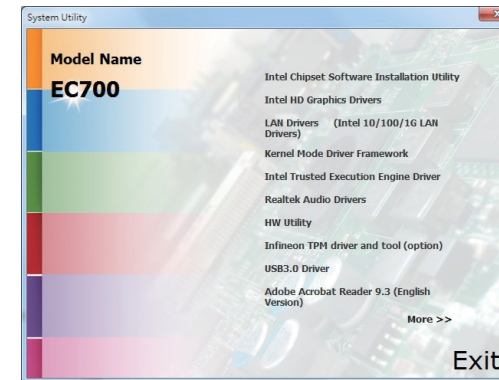

Chapter 8

Intel Chipset Software Installation Utility

The Intel Chipset Device Software is used for updating Windows® INF files so that the Intel chipset can be recognized and configured properly in the system.

To install the utility, click "Intel Chipset Software Installation Utility" on the main menu.

1. Setup is ready to install the utility. Click Next.



2. Read the license agreement then click Yes.



3. Go through the readme document for more installation tips then click Next.



4. After all setup operations are done, click Next.



5. Click "Yes, I want to restart this computer now" then click Finish.

Restarting the system will allow the new software installation to take effect.



Chapter 8

Intel HD Graphics Drivers

To install the driver, click "Intel HD Graphics Drivers" on the main menu.

1. Setup is now ready to install the graphics driver. Click Next.



By default, the "Automatically run WinSAT and enable the Windows Aero desktop theme" is enabled. With this enabled, after installing the graphics driver and the system rebooted, the screen will turn blank for 1 to 2 minutes (while WinSAT is running) before the Windows 7/Windows 8 desktop appears. The "blank screen" period is the time Windows is testing the graphics performance.

We recommend that you skip this process by disabling this function then click Next.

2. Read the license agreement then click Yes.

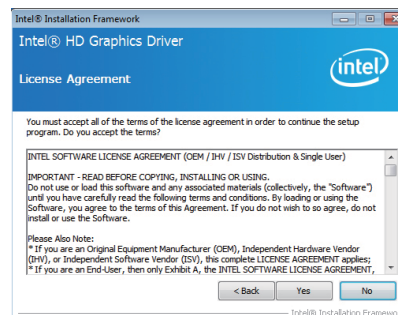

3. Go through the readme document for system requirements and installation tips then click Next.

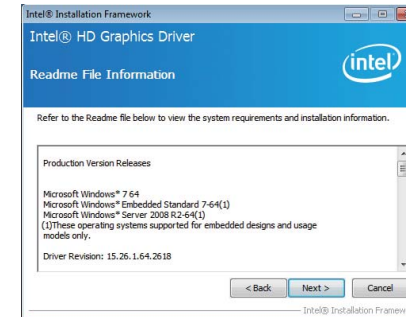

4. Setup is now installing the driver. Click Next to continue.

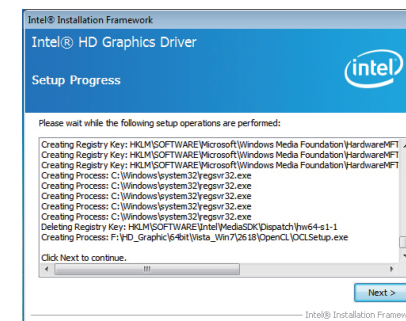

5. Click "Yes, I want to restart this computer now" then click Finish.

Restarting the system will allow the new software installation to take effect.

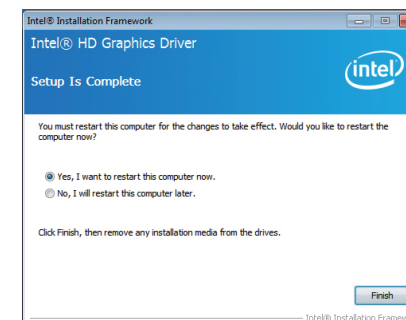

Chapter 8

Intel LAN Drivers

To install the driver, click "Intel LAN Drivers" on the main menu.

1. Setup is ready to install the driver. Click Next.

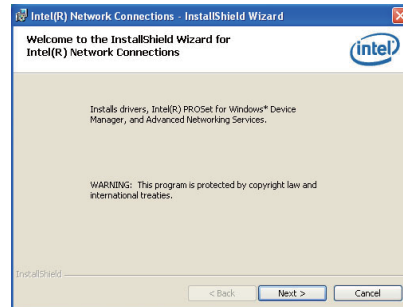

2. Click "I accept the terms in the license agreement" then click "Next".

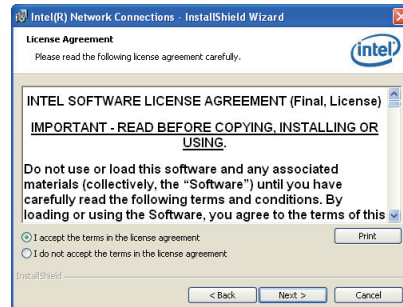

3. Select the program features you want installed then click Next.

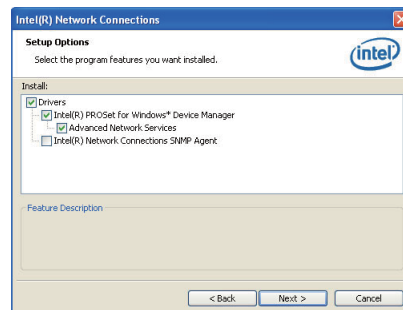

4. Click Install to begin the installation.

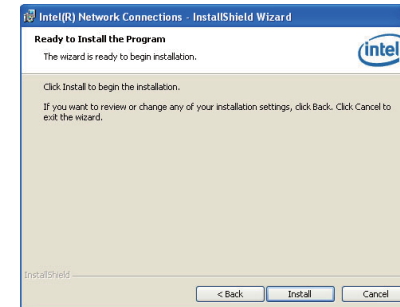

5. After completing installation, click Finish.

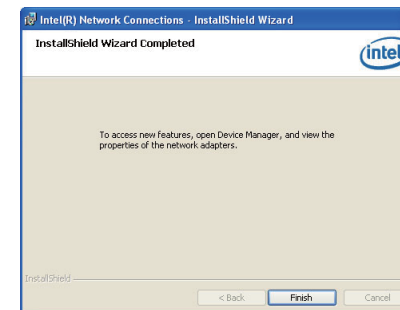

Chapter 8

Kernel Mode Driver Framework (For Windows 7 only)

To install the driver, click "Kernel Mode Driver Framework" on the main menu.

1. Click "Yes" to install the update.

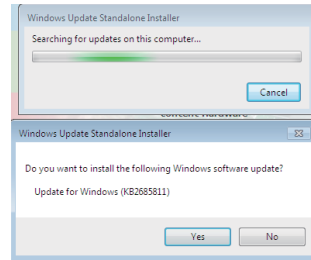

2. The update is installed now.

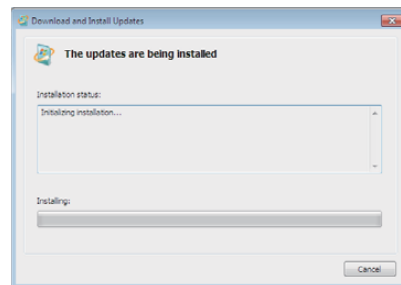

3. Click "Restart Now" to restart your computer when the installation is complete.

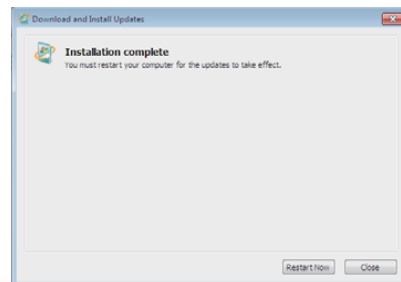

Intel Trusted Execution Engine Driver

To install the driver, click "Intel Trusted Execution Engine Driver" on the main menu.

1. Tick "I accept the terms in the License Agreement" and then click "Next."

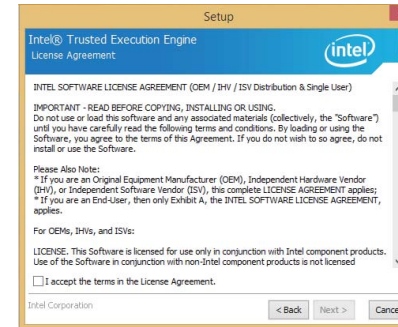

2. The step shows the components which will be installed. Then, Click Next.

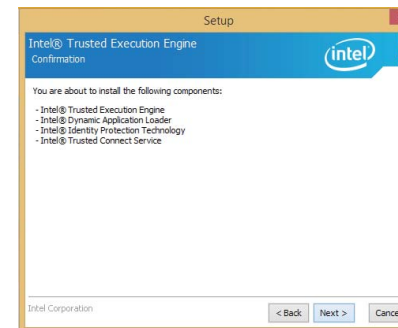

Chapter 8

3. The step displays the installing status in the progress.

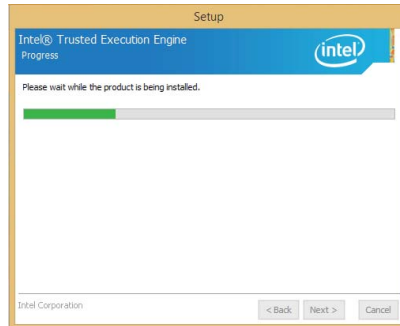

4. Click "Finish" when the installation is complete.

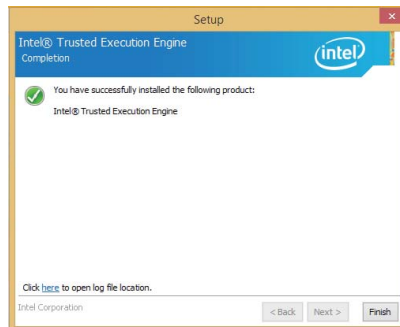

Realtek Audio Drivers

To install the driver, click "Realtek Audio Drivers" on the main menu.

1. Setup is now ready to install the audio driver. Click Next.
2. Follow the remainder of the steps on the screen; clicking "Next" each time you finish a step.



3. Click "Yes, I want to restart my computer now" then click Finish.

Restarting the system will allow the new software installation to take effect.

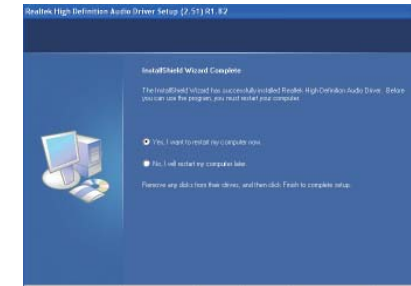

Chapter 8

HW Utility

HW Utility provides information about the board, HW Health, Watchdog, DIO, and Backlight. To access the utility, click “HW Utility” on the main menu.



Note:
If you are using Windows 7, you need to access the operating system as an administrator to be able to install the utility.

1. Setup is ready to install the HW Utility driver. Click Next.

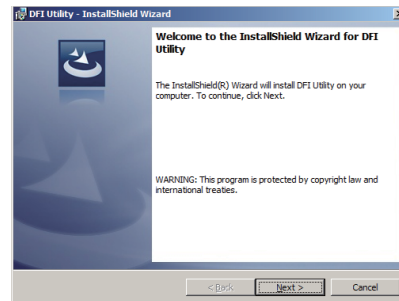

2. Click “I accept the terms in the license agreement” and then click Next.

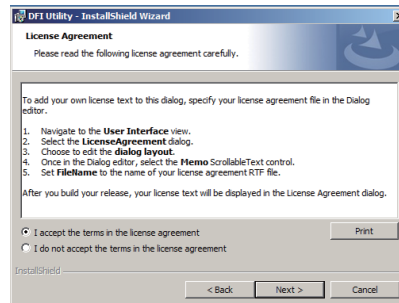

3. Click Install to begin the installation.

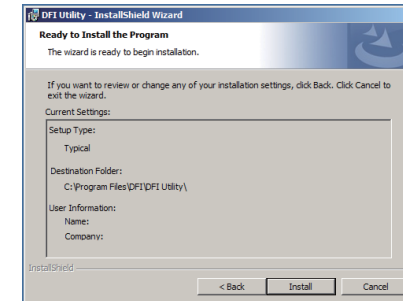

4. After completing installation, click Finish.

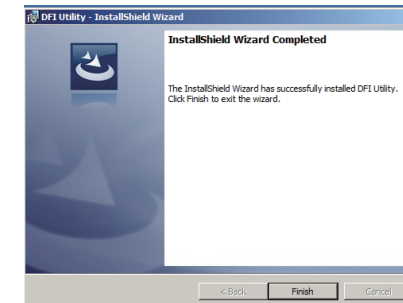

Chapter 8

The HW Utility icon will appear on the desktop. Double-click the icon to open the utility.



Information

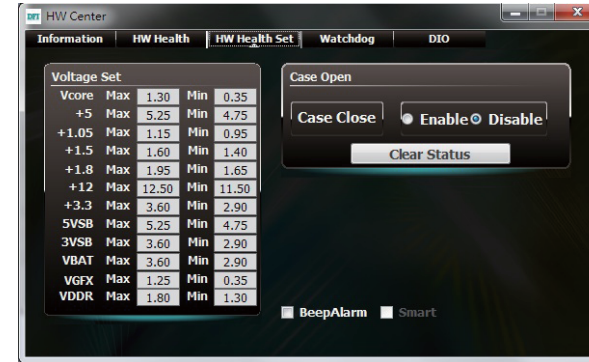

HW Health Set



HW Health

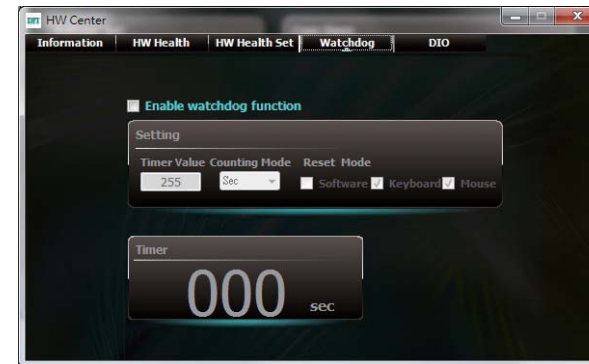

WatchDog

Chapter 8

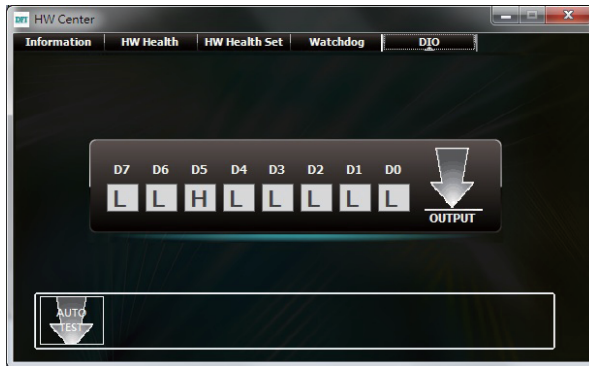

DIO

Infineon TPM Driver and Tool (option)

To install the driver, click “Infineon TPM driver and tool (option)” on the main menu.

1. The setup program is preparing to install the driver.



2. The setup program is now ready to install the utility. Click Next.

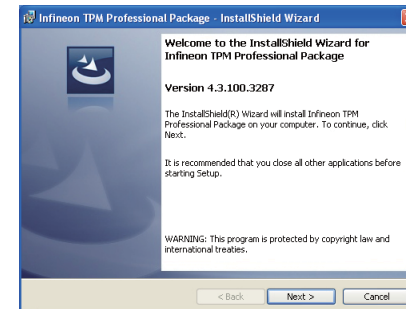

3. Click “I accept the terms in the license agreement” and then click “Next”.

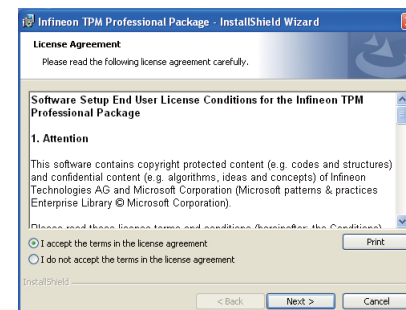

Chapter 8

4. Enter the necessary information and then click Next.

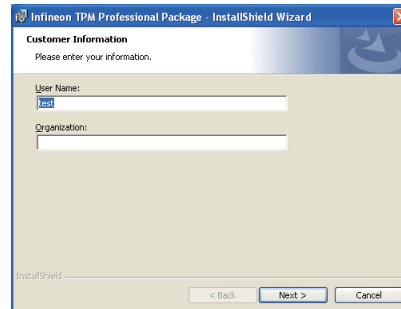

5. Select a setup type and then click Next.

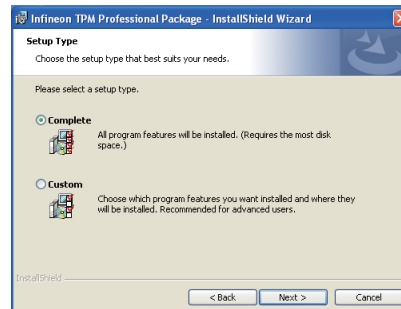

6. Click Install.

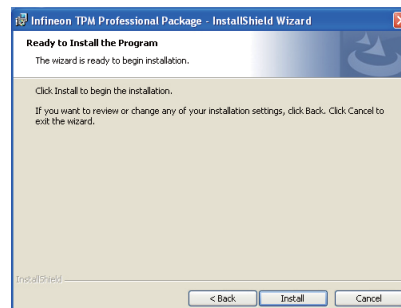

7. TPM requires installing the Microsoft Visual C++ package prior to installing the utility. Click Install.

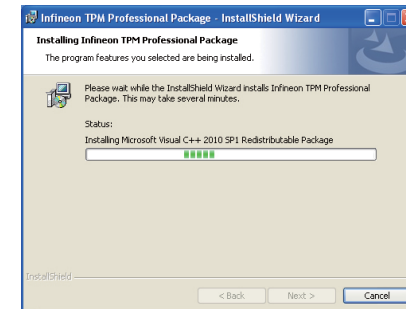

8. The setup program is currently installing the Microsoft Visual C++ package.

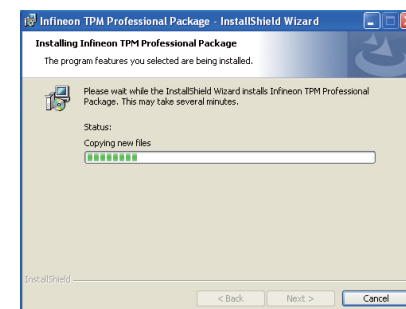

9. Click Finish.



Chapter 8

10. Click "Yes" to restart your system.

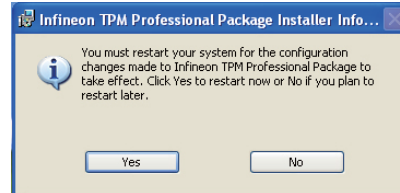

Intel USB 3.0 Drivers (For Windows 7 Only)

To install the driver, click "Intel USB 3.0 Driver" on the main menu.

1. Setup is ready to install the driver. Click Next.

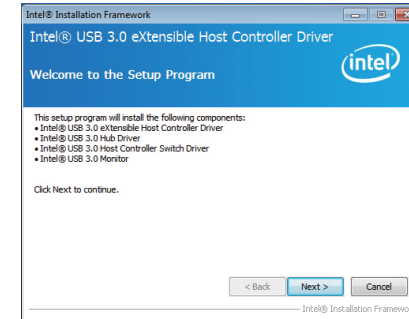

2. Read the license agreement then click Yes.

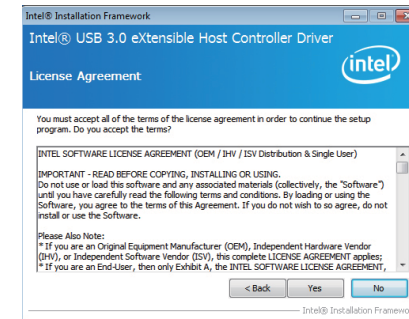

Chapter 8

- Go through the readme document for more installation tips then click Next.

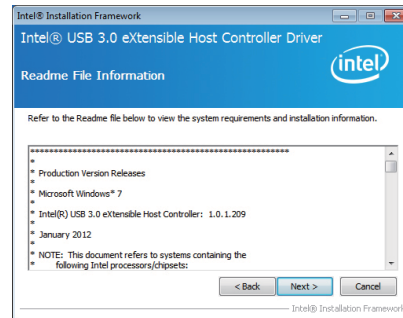

- Setup is currently installing the driver. After installation has completed, click Next.

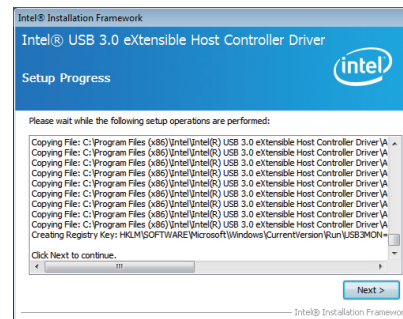

- After completing installation, click Finish.



Adobe Acrobat Reader 9.3

To install the reader, click "Adobe Acrobat Reader 9.3" on the main menu.

- Click Next to install or click Change Destination Folder to select another folder.

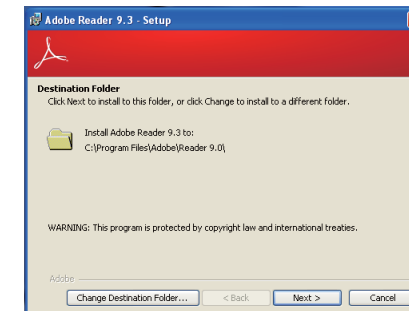

- Click Install to begin installation.

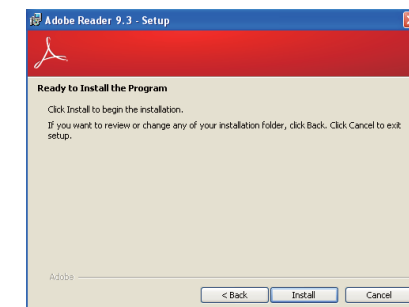

- Click Finish to exit installation.

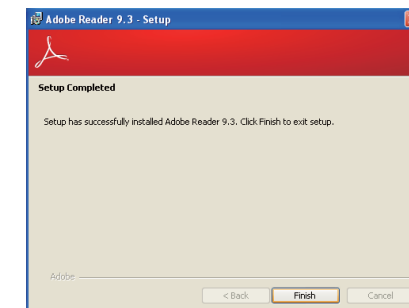

Chapter 9 - Digital I/ O Programming Guide

Register Description

The Input Port Register (register 0) reflects the incoming logic levels of the pins, regardless of whether the pin is defined as an input or output by the Configuration Register. They act only on the read operation. Writes to this register have no effect. The default value (X) is determined by the externally applied logic level. Before a read operation, a write transmission is sent with the command byte to indicate to the I²C device that the Input Port Register will be accessed next.

Register 0 (Input Port Register)

BIT	I-7	I-6	I-5	I-4	I-3	I-2	I-1	I-0
DEFAULT	X	X	X	X	X	X	X	X

The Output Port Register (register 1) shows the outgoing logic levels of the pins defined as outputs by the Configuration Register. Bit values in this register have no effect on pins defined as inputs. In turn, reads from this register reflect the value that is in the flip-flop controlling the output selection, not the actual pin value.

Register 1 (Output Port Register)

BIT	O-7	O-6	O-5	O-4	O-3	O-2	O-1	O-0
DEFAULT	1	1	1	1	1	1	1	1

The Polarity Inversion Register (register 2) allows polarity inversion of the pins defined as inputs by the Configuration Register. If a bit in this register is set (written with 1), the corresponding port pin's polarity is inverted. If a bit in this register is clear (written with a 0), the corresponding port pin's original polarity is retained.

Register 2 (Polarity Inversion Register)

BIT	N-7	N-6	N-5	N-4	N-3	N-2	N-1	N-0
DEFAULT	0	0	0	0	0	0	0	0

The Configuration Register (register 3) configures the direction of the I/O pins. If a bit in this register is set to 1, the corresponding port pin is enabled as an input with a high-impedance output driver. If a bit in this register is cleared to 0, the corresponding port is enabled as an input.

Register 3 (Configuration Register)

BIT	C-7	C-6	C-5	C-4	C-3	C-2	C-1	C-0
DEFAULT	1	1	1	1	1	1	1	1

Chapter 9

Function Description

I2CWriteByte(SlaveAddr, SubAddr, Data):
Write a Byte data to a specified I2C Device.

I2CReadByte(SlaveAddr, SubAddr, *Data):
Read a Byte data from a specified I2C Device.

SetBit(*Data, Bit) :
Set Data bit n as "1".

ClrBit(*Data, Bit) :
Set Data bit n as "0".

GetBit(Data, Bit) :
Return the value of data bit n.

Sample Code

GPIO Configuration

```
# define SLAVE_ADDR      0x42
# define INPUT_PORT     0x00
# define OUTPUT_PORT    0x01
# define INVERSION_PORT 0x02
# define COMFIG_PORT    0x03

GpioConfig(int PinNum, int Mode)
{
    BYTE Data;
    BYTE TempPinNum = PinNum%8;

    //Pin0-7 Input/Output Configuration
    I2C_ReadByte(SLAVE_ADDR, COMFIG_PORT, &Data);
    if(Mode == 1){SetBit(&Data, TempPinNum);} //Input
    else        {ClrBit(&Data, TempPinNum);} //Output
    I2C_WriteByte(SLAVE_ADDR, COMFIG_PORT, Data);

    return 1;
}
```

GPIO Output Process

```
# define SLAVE_ADDR      0x42
# define INPUT_PORT     0x00
# define OUTPUT_PORT    0x01
# define INVERSION_PORT 0x02
# define COMFIG_PORT    0x03

GpioOut(int PinNum, int Level)
{
    BYTE Data;
    BYTE TempPinNum = PinNum%8;

    //Pin0-7
    I2C_ReadByte(SLAVE_ADDR, OUTPUT_PORT, &Data);
    if(Level == 0){ClrBit(&Data, TempPinNum);}
    else        {SetBit(&Data, TempPinNum);}
    I2C_WriteByte(SLAVE_ADDR, OUTPUT_PORT, Data);

    return 1;
}
```

GPIO Input Process

```
# define SLAVE_ADDR      0x42
# define INPUT_PORT     0x00
# define OUTPUT_PORT    0x01
# define INVERSION_PORT 0x02
# define COMFIG_PORT    0x03

GpioIn(int PinNum, int *Status)
{
    BYTE Data;
    BYTE Group = PinNum/8;
    BYTE TempPinNum = PinNum%8;

    //Pin0-7
    I2C_ReadByte(SLAVE_ADDR, INPUT_PORT, &Data);
    *Status = GetBit(Data, TempPinNum);

    return 1;
}
```

Appendix A

Appendix A - Watchdog Sample Code

;Software programming example:

```

;-----
;(1) Enter Super IO Configuration mode
;-----
MOV     DX,2EH
MOV     AL,87H
OUT     DX,AL
OUT     DX,AL

;-----
;(2) Configuration Logical Device 7, register CRF5/CRF6 (WDT Control /WDT
timer)
;-----
MOV     DX,2EH
MOV     AL,07H           ;Ready to Program Logical Device
OUT     DX,AL

MOV     DX,2FH
MOV     AL,07H           ;Select Logical Device 7
OUT     DX,AL

MOV     DX,2EH
MOV     AL, F6H         ;Select watchdog timer register
OUT     DX,AL

MOV     DX,2FH
MOV     AL,10H          ;Set watchdog timer value
OUT     DX,AL

MOV     DX,2EH
MOV     AL, F5H         ;Select watchdog Control Register
OUT     DX,AL

MOV     DX,2FH
MOV     AL,61H          ;Set Watchdog Control Value
OUT     DX,AL

;-----
;(1) Exit extended function mode
;-----
MOV     DX,2EH
MOV     AL,AAH
OUT     DX,AL

```

Appendix B

Appendix B - System Error Message

When the BIOS encounters an error that requires the user to correct something, either a beep code will sound or a message will be displayed in a box in the middle of the screen and the message, PRESS F1 TO CONTINUE, CTRL-ALT-ESC or DEL TO ENTER SETUP, will be shown in the information box at the bottom. Enter Setup to correct the error.

Error Messages

One or more of the following messages may be displayed if the BIOS detects an error during the POST. This list indicates the error messages for all Awards BIOSes:

CMOS BATTERY HAS FAILED

The CMOS battery is no longer functional. It should be replaced.



Important:

Danger of explosion if battery incorrectly replaced. Replace only with the same or equivalent type recommended by the manufacturer. Dispose of used batteries according to the battery manufacturer's instructions.

CMOS CHECKSUM ERROR

Checksum of CMOS is incorrect. This can indicate that CMOS has become corrupt. This error may have been caused by a weak battery. Check the battery and replace if necessary.

DISPLAY SWITCH IS SET INCORRECTLY

The display switch on the motherboard can be set to either monochrome or color. This indicates the switch is set to a different setting than indicated in Setup. Determine which setting is correct, either turn off the system and change the jumper or enter Setup and change the VIDEO selection.

FLOPPY DISK(S) fail (80)

Unable to reset floppy subsystem.

FLOPPY DISK(S) fail (40)

Floppy type mismatch.

Hard Disk(s) fail (80)

HDD reset failed.

Hard Disk(s) fail (40)

HDD controller diagnostics failed.

Hard Disk(s) fail (20)

HDD initialization error.

Hard Disk(s) fail (10)

Unable to recalibrate fixed disk.

Hard Disk(s) fail (08)

Sector Verify failed.

Keyboard is locked out - Unlock the key

The BIOS detects that the keyboard is locked. Keyboard controller is pulled low.

Keyboard error or no keyboard present

Cannot initialize the keyboard. Make sure the keyboard is attached correctly and no keys are being pressed during the boot.

Manufacturing POST loop

System will repeat POST procedure infinitely while the keyboard controller is pull low. This is also used for the M/B burn in test at the factory.

BIOS ROM checksum error - System halted

The checksum of ROM address F0000H-FFFFFH is bad.

Memory test fail

The BIOS reports memory test fail if the memory has error(s).

Appendix C

Appendix C - Troubleshooting Checklist

Troubleshooting Checklist

This chapter of the manual is designed to help you with problems that you may encounter with your personal computer. To efficiently troubleshoot your system, treat each problem individually. This is to ensure an accurate diagnosis of the problem in case a problem has multiple causes.

Some of the most common things to check when you encounter problems while using your system are listed below.

1. The power switch of each peripheral device is turned on.
2. All cables and power cords are tightly connected.
3. The electrical outlet to which your peripheral devices are connected is working. Test the outlet by plugging in a lamp or other electrical device.
4. The monitor is turned on.
5. The display's brightness and contrast controls are adjusted properly.
6. All add-in boards in the expansion slots are seated securely.
7. Any add-in board you have installed is designed for your system and is set up correctly.

Monitor/ Display

If the display screen remains dark after the system is turned on:

1. Make sure that the monitor's power switch is on.
2. Check that one end of the monitor's power cord is properly attached to the monitor and the other end is plugged into a working AC outlet. If necessary, try another outlet.
3. Check that the video input cable is properly attached to the monitor and the system's display adapter.
4. Adjust the brightness of the display by turning the monitor's brightness control knob.

The picture seems to be constantly moving.

1. The monitor has lost its vertical sync. Adjust the monitor's vertical sync.
2. Move away any objects, such as another monitor or fan, that may be creating a magnetic field around the display.
3. Make sure your video card's output frequencies are supported by this monitor.

The screen seems to be constantly wavering.

1. If the monitor is close to another monitor, the adjacent monitor may need to be turned off. Fluorescent lights adjacent to the monitor may also cause screen wavering.

Power Supply

When the computer is turned on, nothing happens.

1. Check that one end of the AC power cord is plugged into a live outlet and the other end properly plugged into the back of the system.
2. Make sure that the voltage selection switch on the back panel is set for the correct type of voltage you are using.
3. The power cord may have a "short" or "open". Inspect the cord and install a new one if necessary.

Floppy Drive

The computer cannot access the floppy drive.

1. The floppy diskette may not be formatted. Format the diskette and try again.
2. The diskette may be write-protected. Use a diskette that is not write-protected.
3. You may be writing to the wrong drive. Check the path statement to make sure you are writing to the targeted drive.
4. There is not enough space left on the diskette. Use another diskette with adequate storage space.

Appendix C

Hard Drive

Hard disk failure.

1. Make sure the correct drive type for the hard disk drive has been entered in the BIOS.
2. If the system is configured with two hard drives, make sure the bootable (first) hard drive is configured as Master and the second hard drive is configured as Slave. The master hard drive must have an active/bootable partition.

Excessively long formatting period.

If your hard drive takes an excessively long period of time to format, it is likely a cable connection problem. However, if your hard drive has a large capacity, it will take a longer time to format.

Serial Port

The serial device (modem, printer) doesn't output anything or is outputting garbled characters.

1. Make sure that the serial device's power is turned on and that the device is on-line.
2. Verify that the device is plugged into the correct serial port on the rear of the computer.
3. Verify that the attached serial device works by attaching it to a serial port that is working and configured correctly. If the serial device does not work, either the cable or the serial device has a problem. If the serial device works, the problem may be due to the onboard I/O or the address setting.
4. Make sure the COM settings and I/O address are configured correctly.

Keyboard

Nothing happens when a key on the keyboard was pressed.

1. Make sure the keyboard is properly connected.
2. Make sure there are no objects resting on the keyboard and that no keys are pressed during the booting process.

System Board

1. Make sure the add-in card is seated securely in the expansion slot. If the add-in card is loose, power off the system, re-install the card and power up the system.
2. Check the jumper settings to ensure that the jumpers are properly set.
3. Verify that all memory modules are seated securely into the memory sockets.
4. Make sure the memory modules are in the correct locations.
5. If the board fails to function, place the board on a flat surface and seat all socketed components. Gently press each component into the socket.
6. If you made changes to the BIOS settings, re-enter setup and load the BIOS defaults.

Assured Systems

Assured Systems is a leading technology company with over 1,500 regular clients in 80 countries, deploying over 85,000 systems to a diverse customer base in 12 years of business. We offer high-quality and innovative rugged computing, display, networking and data collection solutions to the embedded, industrial, and digital-out-of-home market sectors.

US

sales@assured-systems.com

Sales: +1 347 719 4508
Support: +1 347 719 4508

1309 Coffeen Ave
Ste 1200
Sheridan
WY 82801
USA

EMEA

sales@assured-systems.com

Sales: +44 (0)1785 879 050
Support: +44 (0)1785 879 050

Unit A5 Douglas Park
Stone Business Park
Stone
ST15 0YJ
United Kingdom

VAT Number: 120 9546 28
Business Registration Number: 07699660