

4X4 7040 Motherboard Series

4X4-7840U-1U, 4X4-7640U-1U

4X4 Motherboard

KEY FEATURES

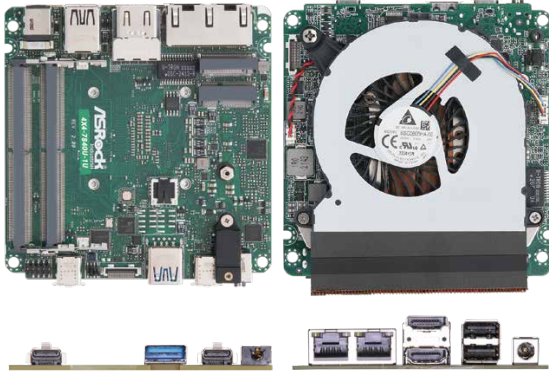

- AMD Ryzen™ 7 7840U/ Ryzen™ 5 7640U
- 2 x 262-pin SO-DIMM DDR5 5600 MHz, up to 64GB (32GB per DIMM)
- 2 x USB4, 1 x USB 3.2 Gen2, 2 x USB 2.0, 1 x M.2 Key E, 1 x M.2 Key M, 1 x SATA3
- 1 x Realtek Gigabit LAN, 1 x Realtek 2.5 Gigabit LAN
- Supports Quad display, 2 x HDMI 2.0, 2 x DP 1.4a (from Type-C)
- 12V~19V DC-In

SPECIFICATIONS

Form Factor

Dimensions	4X4 (4.09-in x 4.02-in x 1.4-in, 10.4 cm x 10.2 cm x 3.6 cm)
------------	--

Processor System

CPU	AMD Ryzen™ 7040U-Series AMD Ryzen™ 7 7840U (Max Speed up to 5.1GHz) AMD Ryzen™ 5 7640U (Max Speed up to 4.9GHz)
BIOS	AMI SPI 256 Mbit

Memory

Technology	Dual Channel DDR5 5600 MHz
Capacity	64GB (32 GB per DIMM)
Socket	2 x 262-pin SO-DIMM

Graphics

Controller	AMD Radeon™ Graphics
HDMI	HDMI 2.0 Max resolution up to 4096x2160@60Hz
DisplayPort	DisplayPort 1.4a Max resolution up to 4096x2160@60Hz
MultiDisplay	Max 4 display (included 2 outputs from Type-C)

Expansion Slot

M.2	1 x M.2 (Key E, 2230) with PCIe Gen4 x1, USB 2.0 for Wireless
-----	---

Audio

Interface	Realtek ALC256, High Definition Audio
-----------	---------------------------------------

Ethernet

Controller/ Speed	LAN1: Realtek RTL8125BG with 10/100/1000/2500 Mbps LAN2: Realtek RTL8111EPV with 10/100/1000 Mbps, support DASH function
Connector	2 x RJ-45

Front I/O

USB	1 x USB 3.2 Gen2 (Type-A) 2 x USB4 (Type-C, 5V/3A, supports DP1.4a display output)
Audio	1 (headphone & microphone jack)

Rear I/O

HDMI	2 x HDMI 2.0
Ethernet	1 x 1 Gigabit LAN, 1 x 2.5 Gigabit LAN
USB	2 x USB 2.0
DC Jack	1

Storage

M.2	1 x M.2 (KEY M, 2242/2260/2280) with PCIe Gen4 x 4 for SSD *M.2 Key M 2280 (supported by bracket)
SATA	1 x SATA3.0 (6.0 Gb/s)

Security

TPM	AMD FW TPM
-----	------------

Watchdog Timer

Output	From Super I/O to drag RESETCON#
Interval	256 Segments, 0, 1, 2, ...255sec

Power Requirements

Input PWR	12V~19V DC-In Jack
Power On	AT/ATX Supported - AT : Directly PWR on as power input ready - ATX : Press button to PWR on after power input ready

Environment

Operating Temp	0°C - 70°C
Storage Temp	-40°C - 85°C
Operating Humidity	5% - 90%
Storage Humidity	5% - 90%

4X4 7040 Motherboard Series

4X4-7840U-1U, 4X4-7640U-1U

4X4 Motherboard

BLOCK DIAGRAM

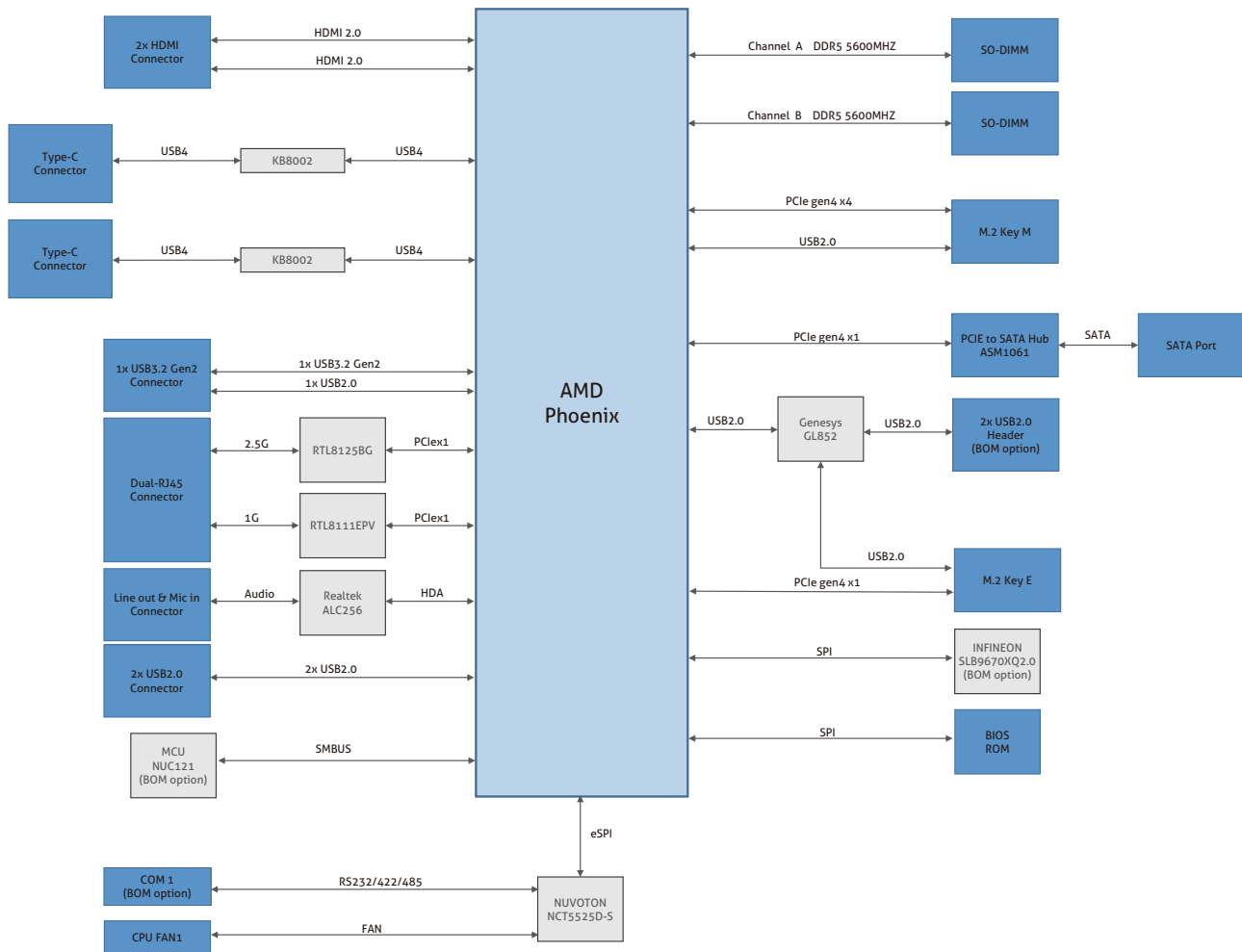

Assured Systems

Assured Systems is a leading technology company with over 1,500 regular clients in 80 countries, deploying over 85,000 systems to a diverse customer base in 12 years of business. We offer high-quality and innovative rugged computing, display, networking and data collection solutions to the embedded, industrial, and digital-out-of-home market sectors.

US

sales@assured-systems.com

Sales: +1 347 719 4508
Support: +1 347 719 4508

1309 Coffeen Ave
Ste 1200
Sheridan
WY 82801
USA

EMEA

sales@assured-systems.com

Sales: +44 (0)1785 879 050
Support: +44 (0)1785 879 050

Unit A5 Douglas Park
Stone Business Park
Stone
ST15 0YJ
United Kingdom

VAT Number: 120 9546 28
Business Registration Number: 07699660