



**AMD® Ryzen™ V1000/R1000 Series  
Desktop Box IPC**



**DT122-GH**



**Features**

- AMD Ryzen V1000/R1000 Desktop Box IPC
- 2 DDR4 SODIMM up to 64GB
- 4 DP++ resolution up to 4096x2160 @ 60Hz
- 1x 3.5" or 2x 2.5" SATA drive bay
- Supports 1 expansion slot: 1 PCIe or 1 PCI
- Built in 150W psu



**Panel**

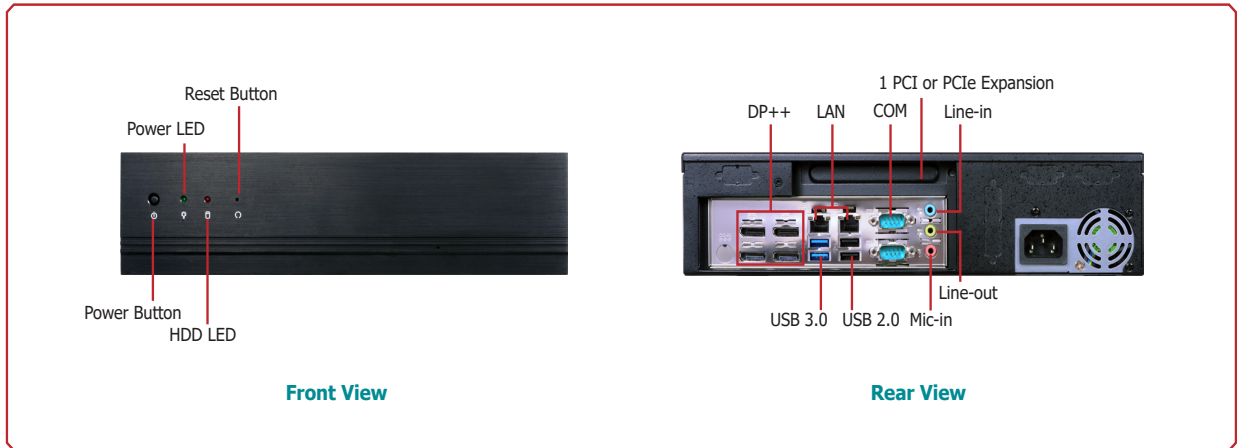

**Dimensions**

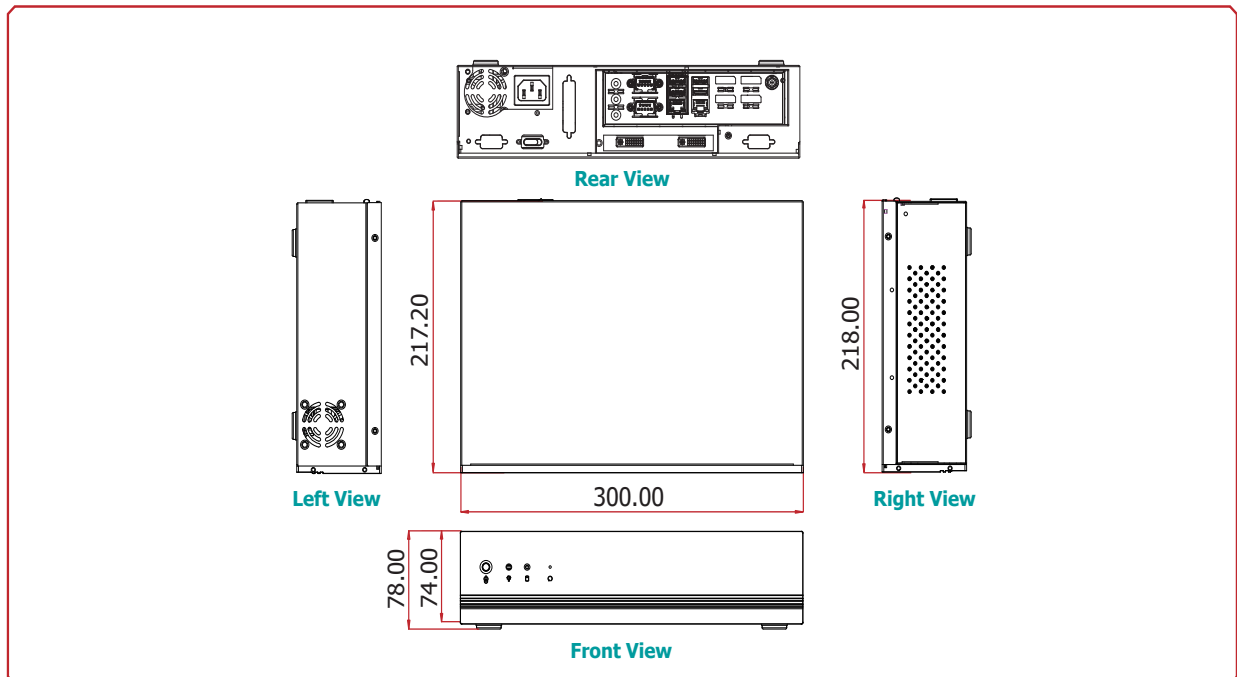



**Specifications**

<b>SYSTEM</b>	<b>Processor</b>	AMD® Ryzen™ Embedded V1000 series AMD® Ryzen™ Embedded V1807, Quad Core, 2M Cache, 11 CU, 3.35GHz (3.8GHz), 35-54W AMD® Ryzen™ Embedded V1756, Quad Core, 2M Cache, 8 CU, 3.25GHz (3.6GHz), 35-54W AMD® Ryzen™ Embedded V1605, Quad Core, 2M Cache, 8 CU, 2.0GHz (3.6GHz), 12-25W AMD® Ryzen™ Embedded V1202, Dual Core, 1M Cache, 3 CU, 2.3GHz (3.2GHz), 12-25W AMD® Ryzen™ Embedded R1000 series
	<b>Memory</b>	Two 260-pin SODIMM up to 32GB      Dual Channel DDR4 3200MHz
	<b>BIOS</b>	AMI BIOS
<b>GRAPHICS</b>	<b>Controller</b>	AMD® Radeon™ Vega Graphics
	<b>Feature</b>	OpenGL 4.5, DirectX 12, OpenCL 2.1 HW Decode: AVC/H.264, MPEG2, VC1/WMV9, JPEG/MJPEG, HEVC/H265, VP8, VP9 HW Encode: MPEG2, AVC/H264, JPEG, HEVC/H265, VP8, VP9
	<b>Display</b>	4 x DP++ (V1000)      DP: resolution up to 4096x2160 @ 60Hz 3 x DP++ (R1000)
	<b>Four Displays</b>	DP++ (R1000 supports triple displays)
<b>STORAGE</b>		1 x 3.5" or 2 x 2.5" SATA 3.0 Drive Bay 1 x M.2 2280 NVME SSD (2280 PCIe x4), (x2 signal with R1000)
<b>EXPANSION</b>	<b>Interface</b>	1 x PCIe or 1 x PCI (through optional riser card)
<b>AUDIO</b>	<b>Audio Codec</b>	Realtek Audio Codec with 5.1 Channel Support
<b>ETHERNET</b>	<b>Controller</b>	2 x Realtek Ethernet LAN Controller
<b>FRONT I/O</b>	<b>LED</b>	1 x Power LED 1 x HDD LED
	<b>Buttons</b>	1 x Power Button 1 x Reset Button
<b>REAR I/O</b>	<b>Ethernet</b>	2 x GbE (RJ-45)
	<b>Serial</b>	1 x RS-232/422/485 (DB-9) 1 x RS-232 (DB-9)
	<b>USB</b>	2 x USB 3.0 2 x USB 2.0
	<b>Display</b>	4 x DP++ (V1000), or 3 x DP++ (R1000)
	<b>Audio</b>	1 x Line-in 1 x Line-out 1 x Mic-in
	<b>Cutout</b>	DB-9 x 2, DB-15, DB-25
<b>COOLING</b>	<b>Fan</b>	1 x System Fan 1 x CPU Fan
<b>WATCHDOG TIMER</b>	<b>Output &amp; Interval</b>	System Reset, Programmable via Software from 1 to 255 Seconds
<b>POWER</b>	<b>Supply</b>	AC150W, ATX, 100 to 240V AC input
<b>OS SUPPORT</b>		Windows 10 Linux
<b>MECHANISM</b>	<b>Construction</b>	Front Bezel aluminum + Chassis Sheet Metal
	<b>Mounting</b>	Wall mount
	<b>Dimensions ( W x H x D )</b>	300mm x 75mm x 217mm
	<b>Weight</b>	3.7 Kg
<b>ENVIRONMENT</b>	<b>Operating Temperature</b>	0 to 45°C
	<b>Storage Temperature</b>	-40 to 85°C
	<b>Relative Humidity</b>	10 to 90% RH (non-condensing)
<b>STANDARDS AND CERTIFICATIONS</b>	<b>Certification</b>	CE, FCC Class A



**DT122-GH**

**Wall Mounting**

**Type A Wall mount bracket**

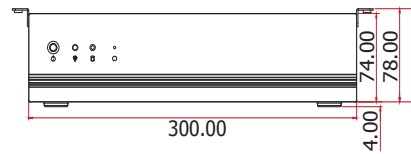
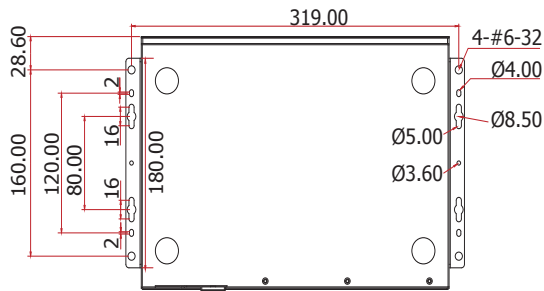
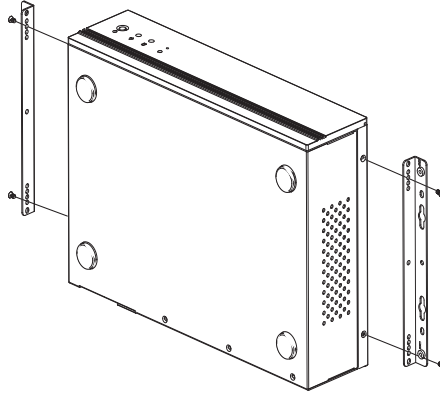

**Type B Wall mount bracket**

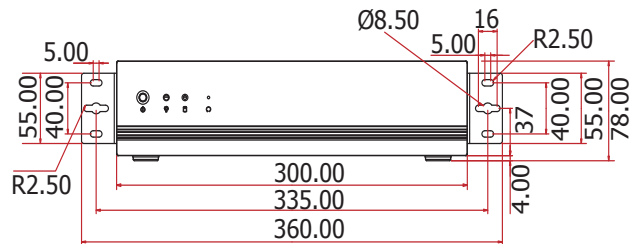
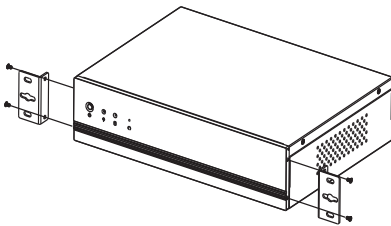

DT122-GH



▶ **Ordering Information**

Model Name	Part Number	Description
DT122-GH	750-DT1222-000G	DT122-GH: GH171-V1807B, 150W, F/G SYSTEM, RoHS
DT122-GH	750-DT1222-100G	DT122-GH: GH171-V1807B, 150W, PCIe Riser, F/G SYSTEM, RoHS
DT122-GH	750-DT1222-200G	DT122-GH: GH171-V1807B, 150W, PCI Riser, F/G SYSTEM, RoHS

▶ **Packing List**

• 1 DT122-GH system unit
• 1 CPU cooler
• 1 HDD drive bay kit
• 1 Heatsink/fan
• 1 Quick Installation Guide

## Assured Systems

Assured Systems is a leading technology company with over 1,500 regular clients in 80 countries, deploying over 85,000 systems to a diverse customer base in 12 years of business. We offer high-quality and innovative rugged computing, display, networking and data collection solutions to the embedded, industrial, and digital-out-of-home market sectors.

### US

[sales@assured-systems.com](mailto:sales@assured-systems.com)

Sales: +1 347 719 4508  
Support: +1 347 719 4508

1309 Coffeen Ave  
Ste 1200  
Sheridan  
WY 82801  
USA

### EMEA

[sales@assured-systems.com](mailto:sales@assured-systems.com)

Sales: +44 (0)1785 879 050  
Support: +44 (0)1785 879 050

Unit A5 Douglas Park  
Stone Business Park  
Stone  
ST15 0YJ  
United Kingdom

VAT Number: 120 9546 28  
Business Registration Number: 07699660