

# DX-1200

12th Gen. Intel® Core™ Series High Performance and Compact Rugged Embedded Computer

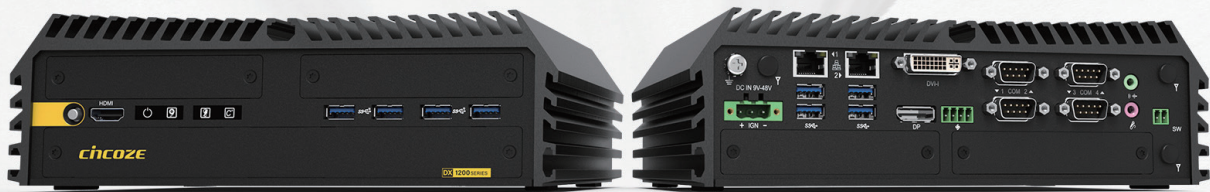

**MAX. PERFORMANCE | MIN. FOOTPRINT**

DX-1200, 12<sup>th</sup> Gen. Intel Alder Lake-S Rugged Embedded Computer

## Overview

The DX-1200 is a fanless embedded computer that packs extreme performance into a rugged, compact chassis, making it the ideal choice for smart manufacturing, machine vision, and edge AI applications. A 12th gen Intel® Core™ (Alder Lake-S) processor (TDP up to 65W) and DDR5 4800 MHz memory provide high-speed computing performance, while additional functions, including rich native I/O and modular expansion design, meet the requirements for a wide range of applications.

- Intel® 12th Gen Alder Lake-S Core™ i9/i7/i5/i3 Processors (max 65 W TDP)
- 2 x DDR5 SO-DIMM Sockets, Supports ECC/non ECC type Memory, Up to 4800MHZ, 64GB
- Quad Independent Display (HDMI / DP / DVI-I)
- 1x M.2 Key E Type 2230 Socket for Intel CNVi / Wireless Module
- CMI Technology for Optional I/O Module Expansions
- CFM Technology for Power Ignition Sensing & PoE Function
- Wide Operating Temperature -40°C to 70°C
- Safety Standard: UL, c-UL, CB, IEC, EN 62368-1



### Rapid Processing and Inference

The DX-1200 supports 12th gen Intel® Core™ i9/i7/i5/i3 (Alder Lake-S) processors based on the Intel 7 process, with up to 16 cores (8P + 8E) and 24 threads, delivering more than 1.35x the speed of Comet Lake-S platform. The Intel® Xe architecture of the UHD 770 graphics chip boosts GPU image classification inference performance to 2.8x the speed of Comet Lake-S, providing the processing performance needed for AI and edge computing.

#### CPU Performance

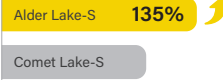

#### GPU Image Classification Inference Performance

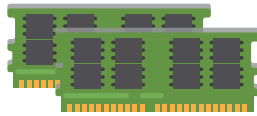

### DDR5 ECC Memory

### High-speed, Safe Memory

Two DDR5 SO-DIMM slots support up to 64GB of 4800MHz memory and include ECC (Error Correction Code) technology, giving the extra stability and reliability needed for industrial automation applications.

### Rich and Diverse Expandability

To cater to the widest range of industrial applications, the DX-1200 provides one M.2 Key E slot and two Mini PCIe slots for the addition of WiFi, GNSS, 4G, and Bluetooth. The Mini PCIe slots also support I/O expansion cards, frame grabber cards, and more, to meet different application requirements.



### High-speed, Reliable Data Transmission

To improve the transfer rate of videos or large files, the DX-1200 supports up to four high-speed 10Gbps LAN ports. And for application environments that require multiple network connections, the DX-1200 supports up to 8x PoE, providing data and power through the same cable to reduce the difficulty of wiring.

### Robust and Reliable

The DX-1200 is built tough, reflected in its industrial-grade protection design and industry certifications in different fields. In addition to features such as wide temperature (-40 - 70°C), wide voltage input (9 - 48 VDC), overvoltage, overcurrent, and ESD protection, it also complies with the US military shock vibration standard MIL-STD-810G. Product safety and reliability are further ensured with internationally recognized UL 62368-1 safety certification. For more secure railway computing, it also passes the EMC EN 50121-3-2 standard in EN 50155 and the EN 45545-2 fire protection standard.



## Specifications

Model Name	DX-1200
<b>System</b>	
Processor	<ul style="list-style-type: none"> <li>12th Generation Intel® Alder Lake-S Series CPU:               <ul style="list-style-type: none"> <li>Intel® Core™ i9-12900E 16 Cores Up to 5 GHz, TDP 65W</li> <li>Intel® Core™ i7-12700E 12 Cores Up to 4.8 GHz, TDP 65W</li> <li>Intel® Core™ i5-12500E 6 Cores Up to 4.5 GHz, TDP 65W</li> <li>Intel® Core™ i3-12100E 4 Cores Up to 4.2 GHz, TDP 60W</li> <li>Intel® Core™ i9-12900TE 16 Cores Up to 4.8 GHz, TDP 35W</li> <li>Intel® Core™ i7-12700TE 12 Cores Up to 4.7 GHz, TDP 35W</li> <li>Intel® Core™ i5-12500TE 6 Cores Up to 4.3 GHz, TDP 35W</li> <li>Intel® Core™ i3-12100TE 4 Cores Up to 4.0 GHz, TDP 35W</li> <li>Intel® Pentium® G7400E 2 Cores Up to 3.6 GHz, TDP 46W</li> <li>Intel® Pentium® G7400TE 2 Cores Up to 3.0 GHz, TDP 35W</li> <li>Intel® Celeron® G6900E 2 Cores Up to 3.0 GHz, TDP 46W</li> <li>Intel® Celeron® G6900TE 2 Cores Up to 2.4 GHz, TDP 35W</li> </ul> </li> </ul>
Chipset	<ul style="list-style-type: none"> <li>Intel R680E Chipset</li> </ul>
Memory	<ul style="list-style-type: none"> <li>2x DDR5 4800 MHz SO-DIMM Socket, Supports Un-buffered and ECC Type, Up to 64GB</li> </ul>
BIOS	<ul style="list-style-type: none"> <li>AMI BIOS</li> </ul>
<b>Graphics</b>	
Graphics Engine	<ul style="list-style-type: none"> <li>Integrated Intel® UHD Graphics 770: Core™ i9/i7/i5</li> <li>Integrated Intel® UHD Graphics 730: Core™ i3</li> <li>Integrated Intel® UHD Graphics 710: Pentium®/Celeron®</li> </ul>
Maximum Display Output	<ul style="list-style-type: none"> <li>Supports Quad Independent Display</li> </ul>
DVI	<ul style="list-style-type: none"> <li>1x DVI-I Connector               <ul style="list-style-type: none"> <li>VGA: 1920 x 1080 @ 60 Hz</li> <li>DVI-D: 1920 x 1200 @ 60 Hz</li> </ul> </li> </ul>
DP	<ul style="list-style-type: none"> <li>1x DP Connector: 4096 x 2304 @ 60Hz               <ul style="list-style-type: none"> <li>* Verified maximum resolution: 3840 x 2160 @ 60Hz</li> </ul> </li> </ul>
HDMI	<ul style="list-style-type: none"> <li>1x HDMI Connector: 3840 x 2160 @ 30Hz</li> </ul>
<b>Audio</b>	
Audio Codec	<ul style="list-style-type: none"> <li>Realtek® ALC888, High Definition Audio</li> </ul>
Line-out	<ul style="list-style-type: none"> <li>1x Line-out, Phone Jack 3.5mm</li> </ul>
Mic-in	<ul style="list-style-type: none"> <li>1x Mic-in, Phone Jack 3.5mm</li> </ul>
<b>I/O</b>	
LAN	<ul style="list-style-type: none"> <li>2x 1GbE LAN, RJ45(Supports Wake on LAN, PXE)               <ul style="list-style-type: none"> <li>GbE1: Intel® I219</li> <li>GbE2: Intel® I210</li> </ul> </li> </ul>
COM	<ul style="list-style-type: none"> <li>4x RS-232/422/485 with Auto Flow Control (Supports 5V/12V), DB9</li> </ul>
USB	<ul style="list-style-type: none"> <li>4x 10Gbps USB 3.2 Gen2, Type A</li> <li>4x 5Gbps USB 3.2 Gen1, Type A</li> </ul>
<b>Storage</b>	
SSD/HDD	<ul style="list-style-type: none"> <li>2x 2.5" SATA HDD/SSD Bay (SATA 3.0)</li> </ul>
mSATA	<ul style="list-style-type: none"> <li>2x mSATA Socket (SATA 3.0, shared by Mini-PCIe socket )</li> </ul>
RAID	<ul style="list-style-type: none"> <li>Support RAID 0/1/5/10</li> </ul>

<b>Expansion</b>	
Mini PCI Express	• 2x Full-size Mini-PCIe Socket
M.2 E Key Socket	• 1x M.2 Key E Type 2230 Socket, Support Intel CNVi Module
SIM Socket	• 1x SIM Socket
CMI (Combined Multiple I/O) Interface	• 2x High Speed CMI Interface for optional CMI Module Expansion • 1x Low Speed CMI Interface for optional CMI Module Expansion
CFM (Control Function Module) Interface	• 1x CFM IGN Interface for optional CFM-IGN Module Expansion
<b>Other Function</b>	
External FAN Connector	• 1x External FAN Connector, 4-pin Terminal Block (Support Smart Fan by BIOS)
Clear CMOS Switch	• 1x Clear CMOS Switch
Reset Button	• 1x Reset Button
Instant Reboot	• Support 0.2sec Instant Reboot Technology
Watchdog Timer	• Software Programmable Supports 256 Levels System Reset
<b>Power</b>	
Power Button	• 1x ATX Power On/Off Button
Power Mode Switch	• 1x AT/ATX Mode Switch
Power Input	• 9-48VDC, 3-pin Terminal Block
Remote Power On/Off	• 1x Remote Power On/Off, 2-pin Terminal Block
<b>Physical</b>	
Dimension ( W x D x H )	• 242 x 173 x 75 mm
Weight Information	• 3.05 kg
Mechanical Construction	• Extruded Aluminum with Heavy Duty Metal
Mounting	• Wall / DIN-RAIL / VESA / Side Mount
Physical Design	• Fanless Design • Cableless Design • Jumper-less Design • Unibody Design
<b>Reliability &amp; Protection</b>	
Reverse Power Input Protection	• Yes
Over Voltage Protection	• Protection Range: 51~58V • Protection Type: shut down operating voltage, re-power on at the preset level to recover
Over Current Protection	• 15A
CMOS Battery Backup	• SuperCap Integrated for CMOS Battery Maintenance-free Operation
MTBF	• 394,488 Hours - Database: Telcordia SR-332 Issue3, Method 1, Case 3
<b>Operating System</b>	
Windows	• Windows® 10
Linux	• Supports by project

Environment	
Operating Temperature	<ul style="list-style-type: none"> <li>• 35W TDP Processor: -40°C to 70°C</li> <li>• 65W TDP Processor: -40°C to 50°C (With External Fan Kit)                             <ul style="list-style-type: none"> <li>- With extended temperature peripherals; Ambient with air flow</li> <li>- According to IEC60068-2-1, IEC60068-2-2, IEC60068-2-14</li> </ul> </li> </ul>
Storage Temperature	<ul style="list-style-type: none"> <li>• -40°C to 85°C</li> </ul>
Relative Humidity	<ul style="list-style-type: none"> <li>• 95% RH @ 70°C (Non-condensing)</li> </ul>
Shock	<ul style="list-style-type: none"> <li>• MIL-STD-810G (Pending)</li> </ul>
Vibration	<ul style="list-style-type: none"> <li>• MIL-STD-810G (Pending)</li> </ul>
EMC	<ul style="list-style-type: none"> <li>• CE, UKCA, FCC, ICES-003 Class A</li> <li>• EN 50155 (EN 50121-3-2 Only)</li> <li>• E-Mark</li> </ul>
Safety	<ul style="list-style-type: none"> <li>• UL, cUL, CB, IEC/EN 62368-1 (Pending)</li> </ul>
Fire Protection	<ul style="list-style-type: none"> <li>• EN 45545-2</li> </ul>

**External Layout**

Front I/O

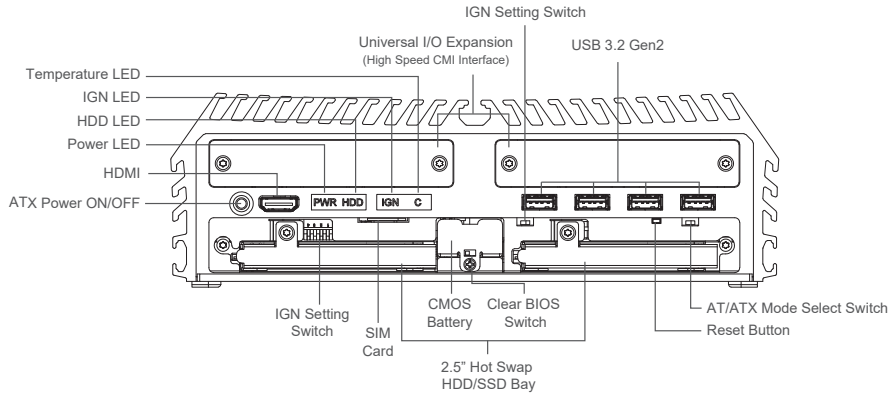

Rear I/O

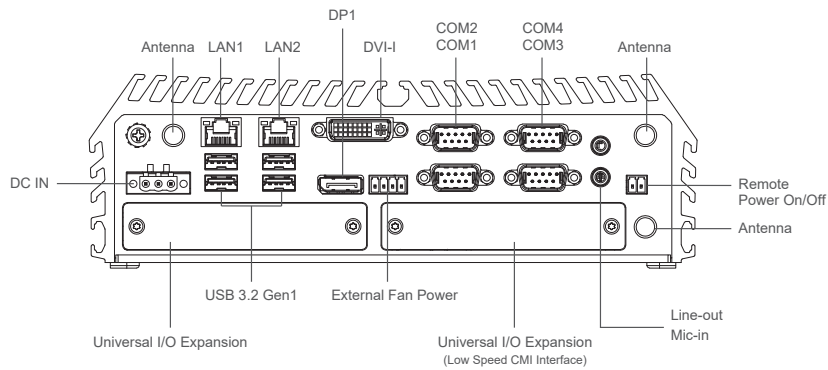

**Dimensions**

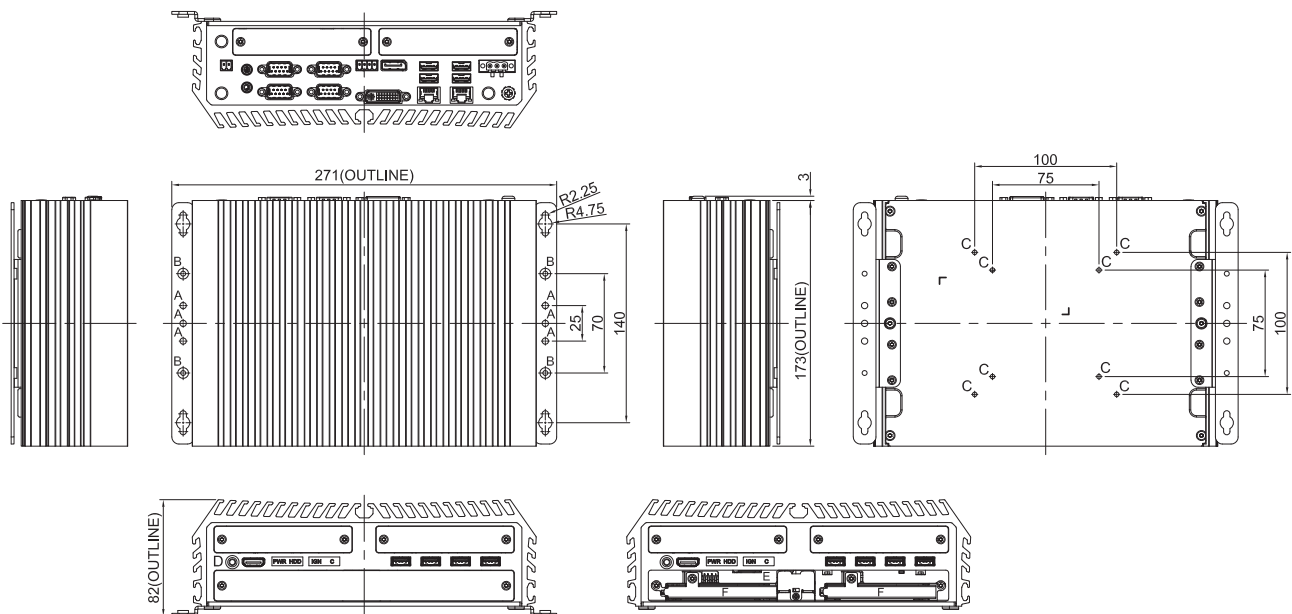

Unit: mm

## Ordering Information

### Available Models

Model No.	Description
DX-1200-R10	12th Gen. Intel® Core™ Series High Performance and Compact Rugged Embedded Computer

### Package Checklist







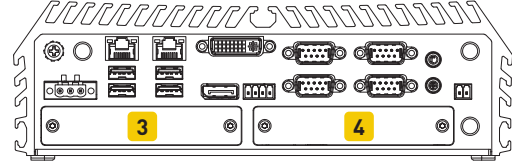
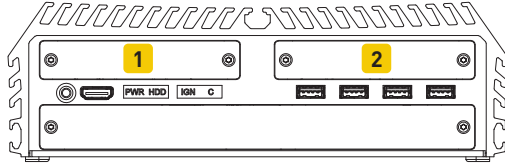

• DX-1200 Rugged Computer x1	• Power Terminal Block Connector x1
• CPU Heatsink Pack x1	• Remote Power On/Off Terminal Block Connector x 1
• Screw Pack x 1	• Fan Terminal Block Connector x 1
• Wall Mounting Kit x1	• DVI-I to VGA Adaptor x 1

### Optional Modules and Accessories

Model No.	Description
CFM-PoE01	CFM Module with PoE Control Function, Individual Port 25.5W
CFM-IGN01	CFM Module with Power Ignition Sensing Control Function, 12V/24V Selectable
CMI-LAN01-R12	CMI Module with 4x RJ45 Intel I210 1GbE LAN Ports
CMI-10GLAN05-R10	CMI Module with 2x Intel 10GbE LAN, RJ45 Port
CMI-M12LAN01-R12	CMI Module with 4 x M12 Intel I210 1GbE LAN Ports
CMI-XM12LAN01-R10	CMI Module with M12 X-Coded Connector, 4x Intel I210 1GbE LAN Ports
CMI-DIO01	CMI Module with 16DIO (8in 8out)
CMI-COM01	CMI Module with 2x RS232/422/485 (Support 5V/12V)
MEC-COM-M212-TDB9	Mini-PCIe Module with 2x RS-232 Serial Ports, 1x Thin DB9 Cable
MEC-COM-M334-TDB9	Mini-PCIe Module with 4x RS-232/422/485 Serial Ports, 2x Thin DB9 Cable
MEC-LAN-M102-30	Mini-PCIe Module with 2x LAN Ports, 2x 30cm cable
UB0930-R10	Universal Bracket with 4x M12 X-Coded Cutout
UB1303	Universal Bracket with 2x DB9 Cutout
UB1311	Universal Bracket with 2x RJ45 Cutout for MEC-LAN Expansion
UB1318	Universal Bracket with DIO Cutout
UB1710-R10	Universal Bracket with 4x M12 A-Coded Cutout
UB1712-R10	Universal Bracket with 4x RJ45 Cutout
UB1728-R10	Universal Bracket with 2x RJ45 Cutout for CMI-10GLAN Expansion
SIDE-DX	DX Series side mount kit
DIN01	DIN-RAIL Mount Kit, KMRH-K175
GST120A24-CIN	Adapter AC/DC 24V 5A 120W with 3pin Terminal Block Plug and Tubes, Level VI
GST220A24-CIN	Adapter AC/DC 24V 9.2A 220W with 3pin Terminal Block Plug and Tubes, Level VI
FAN-EX101	External Fan with 4pin Terminal Block Plug and Mounting Bracket, Support smart fan

**Optional Module Configuration**



Model No.	Description	1	2	3	4
CMI-LAN01-R12/UB1712-R10 	CMI Module with 4x Intel I210 1GbE LAN, RJ45 Port / Universal Bracket with 4x RJ45 Cutout	V	V	--	--
CMI-10GLAN05-R10/UB1728-R10 	CMI Module with 2x Intel 10GbE LAN, RJ45 Port/ Universal Bracket with 2x RJ45 Cutout	V	V	--	--
CMI-M12LAN01-R12/UB1710-R10 	CMI Module with M12 Connector, 4x Intel 1GbE LAN / Universal Bracket with 4x M12 A-Coded Cutout	V	V	--	--
CMI-XM12LAN01-R10/UB0930-R10 	CMI Module with M12 X-Coded Connector, 4x Intel I210 1GbE LAN Ports / Universal Bracket with 4x M12 X-Coded Cutout	V	V	--	--
CMI-DIO01/UB1318 	CMI Module with 16DIO (8in 8out) / Universal Bracket with DIO Cutout	--	--	--	V
CMI-COM01/UB1303 	CMI Module with 2x RS232/422/485 (Support 5V/12V) / Universal Bracket with 2x DB9 Cutout	--	--	--	V
MEC-COM-M212-TDB9/UB1303 	Mini-PCIe Module with 2x RS-232 Serial Ports, 1x Thin DB9 Cable / Universal Bracket with 2x DB9 Cutout	--	--	V	V
MEC-COM-M334-TDB9/2xUB1303 	Mini-PCIe Module with 4x RS-232/422/485 Serial Ports, 2x Thin DB9 Cable / 2x Universal Bracket with 2x DB9 Cutout	--	--	V	
MEC-LAN-M102-30/UB1311 	Mini-PCIe Module with 2x LAN Ports, 2x 30cm cable / Universal Bracket with 2x RJ45 Cutout for MEC-LAN Expansion	--	--	V	--



## Assured Systems

Assured Systems is a leading technology company with over 1,500 regular clients in 80 countries, deploying over 85,000 systems to a diverse customer base in 12 years of business. We offer high-quality and innovative rugged computing, display, networking and data collection solutions to the embedded, industrial, and digital-out-of-home market sectors.

### US

[sales@assured-systems.com](mailto:sales@assured-systems.com)

Sales: +1 347 719 4508  
Support: +1 347 719 4508

1309 Coffeen Ave  
Ste 1200  
Sheridan  
WY 82801  
USA

### EMEA

[sales@assured-systems.com](mailto:sales@assured-systems.com)

Sales: +44 (0)1785 879 050  
Support: +44 (0)1785 879 050

Unit A5 Douglas Park  
Stone Business Park  
Stone  
ST15 0YJ  
United Kingdom

VAT Number: 120 9546 28  
Business Registration Number: 07699660