

VITAM-117P/R/G(H)

17" IP66 / IP69K Stainless Steel Display

Industrial Panel PC

HMI Controller

Industrial Display Monitor

Box PC



Features

- 17" New Generation Stainless Steel Display
- True Flat Front Bezel Design and Grade 304 Stainless Steel Enclosure (Grade 316 for Option)
- IP66/IP69K Rated with M12 (W.F.) Connectors
- Support Resistive Touch, Projected Capacitive Touch, and Glass
- Touch on/off Button on the Side Edge for Hygienic Cleaning
- Support Ergonomic Versatile Mounting: Yoke Mounting / Space-saving VESA 75 x 75 mm Mounting

Specifications

IO Port	
VGA	1 x M12 12-pin for VGA with waterproof cover and chain
HDMI	1 x W.F. HDMI with waterproof cap
USB	1 x M12 USB 2.0 with waterproof cover and chain
Speaker	1 x 2W IP65 speaker (option)
OSD Control Membrane	OSD on the rear side
Power Connector	1 x M12 3-pin for DC power with waterproof cover and chain

Display	Standard	High Brightness Optional
Display Type	17" TFT-LCD	17" TFT-LCD
Max. Resolution	1280 x 1024	1280 x 1024
Max. Color	16.7M	16.7M
Luminance (cd/m ²)	350	1000
View Angle	160(H)/140(V)	160(H)/140(V)
Contrast	800:1	800:1
Backlight Lifetime	50,000 hrs	50,000 hrs

Touch Screen	
Type	Resistive Touch (for R model) Projected Capacitive Touch (for P model) Glass (for G model)
Interface	USB
Light Transmission(%)	Resistive Touch : 80% Projected Capacitive : 90%

Power	
Power Input	DC 9~36V
Power Consumption	VITAM-117R: Max 19W

Mechanical	
Construction	304 Stainless steel chassis(default), 316 Stainless steel chassis(optional)
Mounting	VESA Mount 75 x 75, Yoke mount (option)
IP Rating	Total IP66/IP69K
Dimensions	432 x 358 x 55.3 mm
Net Weight	7.5 kg

Dimensions

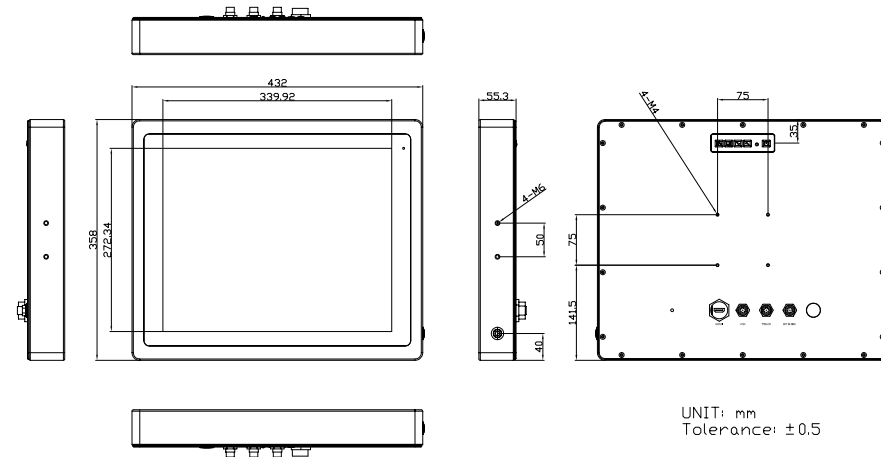

Environmental	
Operating Temperature	0~50°C / -20~60°C for option
Storage Temperature	-30~70°C
Humidity	10 to 95% @ 40°C, non-condensing
Certificate	CE/FCC Class A

Ordering Information	
VITAM-117P	17" SXGA IP66/IP69K stainless steel display, VGA/HDMI input, OSD on the rear side, projected capacitive touch, 9~36V DC power input with Adapter
VITAM-117R	17" SXGA IP66/IP69K stainless steel display, VGA/HDMI input, OSD on the rear side, 5 wire resistive touch window, 9~36V DC power input with Adapter
VITAM-117G	17" SXGA IP66/IP69K stainless steel display, VGA/HDMI input, OSD on the rear side, protection glass, 9~36V DC power input with Adapter
VITAM-117PH	17" SXGA IP66/IP69K stainless steel display, VGA/HDMI input, OSD on the rear side, projected capacitive touch, 9~36V DC power input with Adapter, 1,000 nits LCD
VITAM-117RH	17" SXGA IP66/IP69K stainless steel display, VGA/HDMI input, OSD on the rear side, 5 wire resistive touch window, 9~36V DC power input with Adapter, 1,000 nits LCD
VITAM-117GH	17" SXGA IP66/IP69K stainless steel display, VGA/HDMI input, OSD on the rear side, protection glass, 9~36V DC power input with Adapter, 1,000 nits LCD

Assured Systems

Assured Systems is a leading technology company with over 1,500 regular clients in 80 countries, deploying over 85,000 systems to a diverse customer base in 12 years of business. We offer high-quality and innovative rugged computing, display, networking and data collection solutions to the embedded, industrial, and digital-out-of-home market sectors.

US

sales@assured-systems.com

Sales: +1 347 719 4508
Support: +1 347 719 4508

1309 Coffeen Ave
Ste 1200
Sheridan
WY 82801
USA

EMEA

sales@assured-systems.com

Sales: +44 (0)1785 879 050
Support: +44 (0)1785 879 050

Unit A5 Douglas Park
Stone Business Park
Stone
ST15 0YJ
United Kingdom

VAT Number: 120 9546 28
Business Registration Number: 07699660