

Hisense

HIK Series



HIK SERIES

P2.5 INDOOR LED DISPLAY

HIK series LED solutions deliver unrivalled versatility due to the variety of cabinet configurations available. Integrators specifying the HIK range have access to the broadest range of pixel pitch and aspect ratios options. Perfect for any internal space, these innovative Hisense LED modules include cable-less internal construction and full frontal access for ease of maintenance.

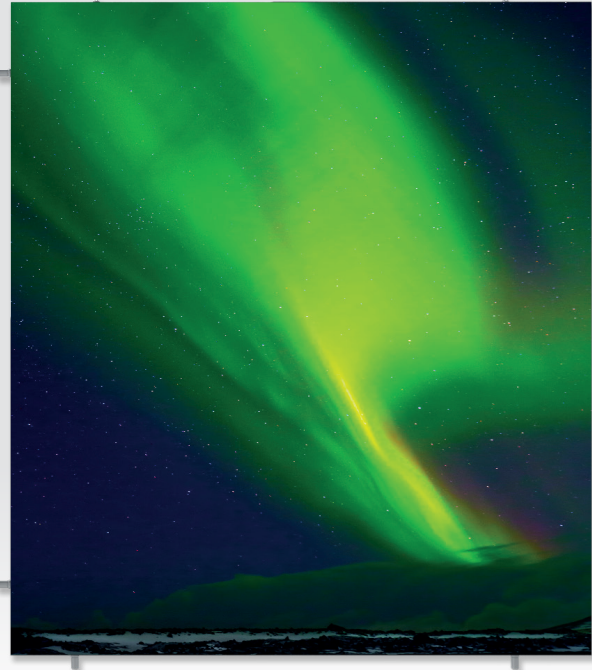

Highlights



High refresh rate

With uniform color scale and brightness, dynamic performance of LED display could restore the true scenes without any ripples.



Brightness nits

With an average 500 nits and 1,000 nits maximum brightness, the display panels can deliver amazingly vivid imagery anywhere during daytime and nighttime conditions.



Low brightness & High gray level

LED display could reveal more details, including layers and colors, than traditional displays do.



160° High viewing angle

The extra wide 160° viewing angle is a perfect fit for large groups of people that will view the displays from diverse angles while passing by.



High color calibration

LED display correction technology could uniformly lighten several hundred thousand LED lights, presenting a uniform display effect with the same brightness and color scale.



AOB Admixture on board

AOB Transparent glass on surface enhances the mixed light property with scratch resistance, water-proof & easy to clean.



Hisense

HIK Series

Specifications

HIK Series

Pixel Pitch	P2.5
LED Type	SMD2121 3in1
Thickness	53.7mm
Module Size (W H/mm)	240 x 270
Cabinet Dimension (W H/mm)	480 x 540 / 480 x 270 / 240 x 540
Cabinet Resolution	192 x 216
Cabinet Weight (kg/panel)	≤7kg (480 x 540) / ≤4kg (480 x 270) / ≤4kg (240 x 540)
Brightness (Nits)	500 (0-1000 Adjustable)
Contrast Ratio	7000:1
Maintanance	Front Access
IP Rating	IP50
Max Power Consumption (W/sqm)	≤650
Avg Power Consumption (W/sqm)	≤150
Viewing Angle	160°
Refresh Rate (Hz)	3840
Operating Enviroment	-10° to 40° / 10 to 90% Relative Humidity (non condensing)
Life Span	100,000 Hours

Display Dimensions

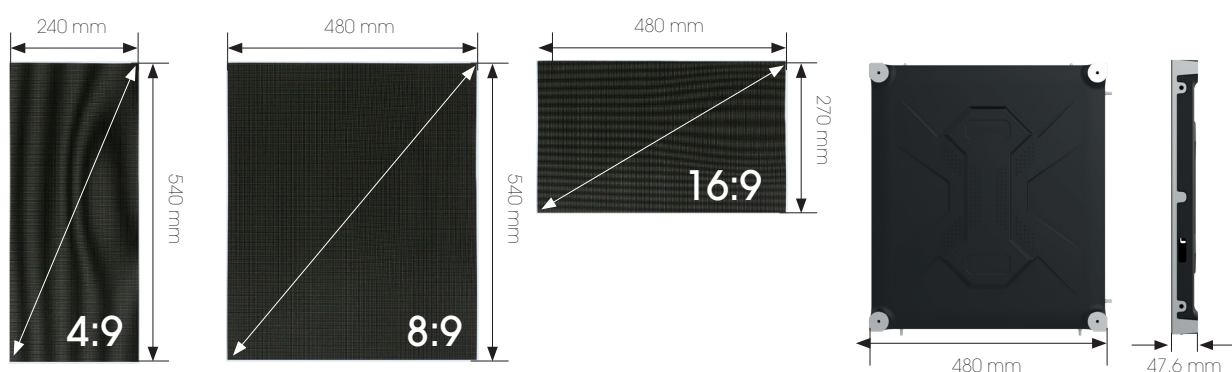

HISENSE B2B EUROPE

Beechavenue 139,
1119 RB Schiphol-Rijk,

Netherlands
sales@hisense-b2b.com

www.hisense-b2b.com
+44 (0)115 8248811

Assured Systems

Assured Systems is a leading technology company with over 1,500 regular clients in 80 countries, deploying over 85,000 systems to a diverse customer base in 12 years of business. We offer high-quality and innovative rugged computing, display, networking and data collection solutions to the embedded, industrial, and digital-out-of-home market sectors.

US

sales@assured-systems.com

Sales: +1 347 719 4508
Support: +1 347 719 4508

1309 Coffeen Ave
Ste 1200
Sheridan
WY 82801
USA

EMEA

sales@assured-systems.com

Sales: +44 (0)1785 879 050
Support: +44 (0)1785 879 050

Unit A5 Douglas Park
Stone Business Park
Stone
ST15 0YJ
United Kingdom

VAT Number: 120 9546 28
Business Registration Number: 07699660