

U.K. ☎ +44 1785 879050 U.S. ☎ +1 347 7194508 www.assured-signage.com

Sureview 10" POS Network Android PCAP Touch Screen



Small-sized touch displays, ideal for meeting room booking or point-of-sale applications

Power Over Ethernet (PoE)

Power your screen by using the power cable provided or supply the power over an Ethernet cable. This minimises the number of cables needed for installation as you can supply power and internet connectivity to the screen simultaneously.

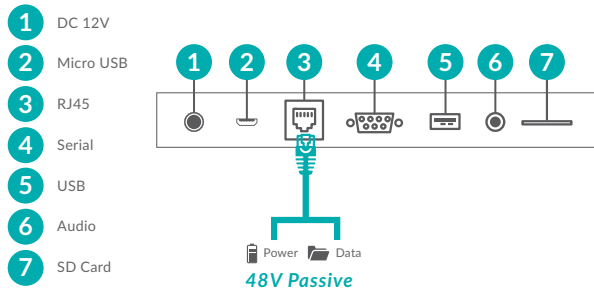

Stylish Enclosure

The modern enclosure is crafted from moulded polymer for ultimate aesthetics. With it's fingerprint resistant matte black finish and rounded corners the screen can fit seamlessly in many environments such as corporate offices or retail spaces.

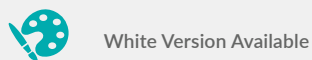
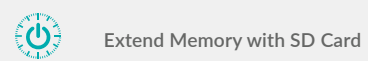
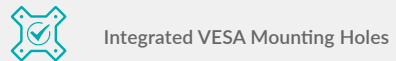
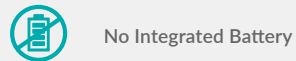
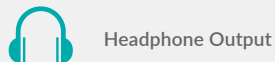
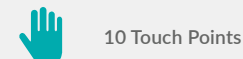
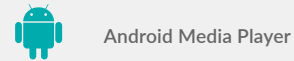

Other Features

PCAP Touch Screen

State of the art Projected Capacitive interactive technology offers the most responsive and sensitive touch experience available.



Meeting Room Solution

This display is ideal to be used in conjunction with meeting room booking software. The LED frame can act as a room availability indicator.



24/7 Commercial Use

These displays use a commercial grade LCD panel and LED backlight. They have the ability to be in constant use 24/7 for over 70,000 hours and have no external buttons or controls to avoid tampering.



No Integrated Battery

Unlike domestic tablets these displays do not have built-in batteries and therefore last considerably longer. They are designed to be used constantly 24/7 in public spaces and can be powered directly from the mains or over PoE.



VESA Mounting Holes

Unlike domestic tablets these displays have an integrated and secure screw based mounting solution on the rear for easy wall or stand installation.



Multi Coloured LED Frame

The LED edges either side of the display can be red, green, blue, magenta, cyan, yellow and white. They can also be disabled completely if preferred.

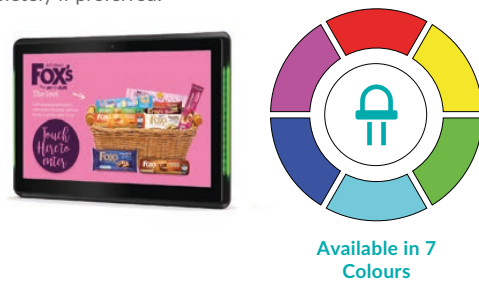

Integrated Camera

If the software you are using requires a camera you can use the screen's integrated front facing 2 megapixel camera.

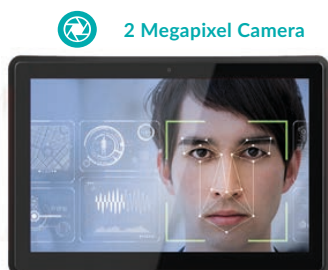

Optional NFC Integration

For projects that require Near Field Communication an internal module can be implemented for even more interactivity and engagement.



Key Features



10 TOUCH POINTS



INTEGRATED CAMERA



LANDSCAPE OR PORTRAIT
ORIENTATION



24/7 COMMERCIAL GRADE



INTEGRATED SPEAKERS



ANDROID MEDIA PLAYER



HEADPHONE OUTPUT



MULTI-COLOUR LED FRAME

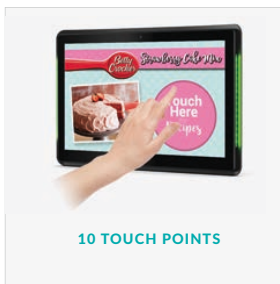

10 TOUCH POINTS



POWER OVER
ETHERNET

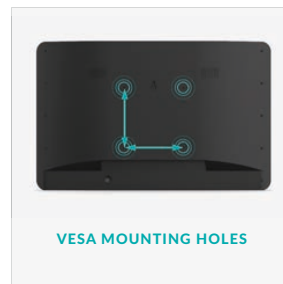

VESA MOUNTING HOLES

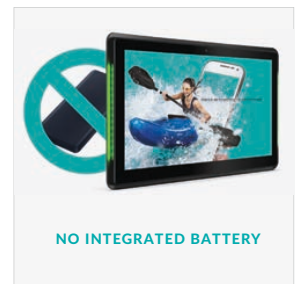

NO INTEGRATED BATTERY

SUREVIEW

Specification Table

		10 Inch
Panel	Resolution	1280x800
	Display Area (mm)	216.96x135.6
	Aspect Ratio	16:10
	Brightness (cd/m ²)	250
	Colour	16.7M
	Colour Depth	8 Bit
	Viewing Angle	178°
	Contrast Ratio	800:1
Audio	Speaker Type	2x2W
Touch	Touch Technology	Projected Capacitive
	Touch Points	10
	Glass Hardness	7H minimum
AV Ports	Inputs	Micro USB, 1x USB 3.0, 1x USB 2.0
	Outputs	Audio Socket (3.5mm)
Power	Power Consumption (W)	11
	Input Voltage	12V/2A
	PoE Mode	48V Passive
Mechanical	Unit Size (WxHxD mm)	273.7x189.7x30.2
	Package Size (WxHxD mm)	368x234x75
	VESA Holes (mm)	75x75
	Net Weight (kg)	0.75
	Gross Weight (kg)	1.15
Environmental	Operating Temperature	0 °C to 50 °C
	Storage Temperature	-30°C to 60°C
	Operating Humidity	10% to 80%
	Storage Humidity	5% to 95%
Computer	Media Formats	Video (MPG, AVI, MP4, RM, RMVB, TS), Audio (MP3, WMA), Image (JPG, GIF, BMP, PNG)
	Media Resolution	1920x1080/1080x1920
	CPU	Quad-core Cortex-A17 1.8GHz,RockChip RK3288
	GPU	Mali-T764
	RAM	2GB
	Internal Storage	16GB
	Storage Extension	SD Card
	USB	USB3.0 HOST x1
	Wi-Fi	802.11b/g/n
	LAN	100M/1000M
	Bluetooth	Bluetooth 4.0
	OS	Android 8.1
	Graphic Engine	OpenGL ES 1.1/2.0
Accessories	Included	Wall Mount
	Optional	Network Upgrade, PCAP Touch Screen Upgrade, Table Stand, Near Field Communication
Warranty	Warranty Period	3 Year Warranty
	Technical Support	Lifetime

Errors and omissions excepted



SUREVIEW

Technical Drawing

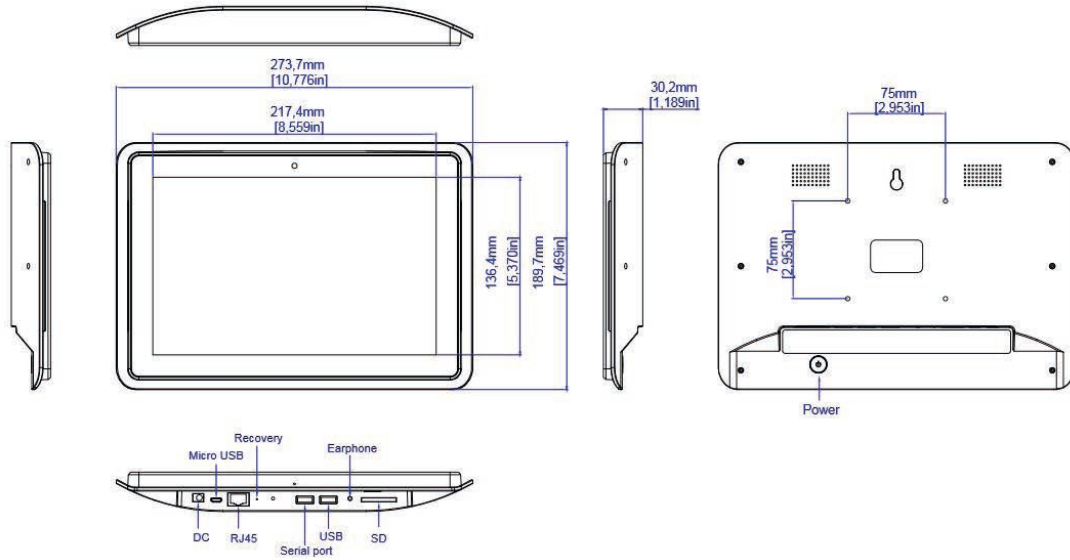

Why Choose Our Commercial Display Solutions?



Lifetime Technical Support

From the moment you receive your product, throughout the duration of your warranty and even after your warranty has expired we are here to support you. If you require any assistance setting up or using your product, or have any problems at all, we can provide free technical support via telephone and email.



On-site Support and Maintenance*

If needed, we can provide an installation service for any of our products. We can also set up service-level agreements for larger projects that require maintenance contracts.



Extended Warranty*

All of our commercial display products come with a 3 year commercial warranty as standard but if you want to extend this you can upgrade this to cover a 5 year period at point of purchase.



Training

As well as providing free remote CMS training sessions and webinars we can also visit you to deliver bespoke training for our software and hardware*.



Advanced Replacements†

Should your display suffer from any kind of hardware failure during the warranty period we will send you an advanced replacement and arrange for your old display to be collected, free of charge. This ensures no downtime where you are without a screen.



Custom Product Testing & Configuration

If you need us to test third party software or a website, or configure your screen in a particular way before it is dispatched (e.g. in a particular orientation or network mode), we can do so to make your life easier.



3D Rendering

Want to know how a particular screen will look once installed? Send us a photo of the location and we will create a 3D rendering of any screen in situ to help you to visualise how amazing it will look.



Logistics Support

We hold more stock in our UK warehouse than any other manufacturer so we can help you meet tight deadlines. For last minute orders we can also offer special express or morning delivery options*. We also carry out UK based quality control checks on every display before it leaves our warehouse.



Project Support

If you need to loan a sample unit to test we'd be more than happy to arrange this. We can also provide a rental service for temporary projects*.



Customisation*

Your display can be customised to suit your requirements by adding your logo or printed graphics or even tailoring the colour of a display. We can also carry out hardware modifications to existing products or manufacture bespoke solutions for special projects.



Extras*

As well as being able to provide accessories and add-ons, such as extra remote controls, NUC PCs and video wall controllers, we can also supply custom made flight cases which are great if a display needs to be moved safely from place to place.

Assured Systems

Assured Systems is a leading technology company with over 1,500 regular clients in 80 countries, deploying over 85,000 systems to a diverse customer base in 12 years of business. We offer high-quality and innovative rugged computing, display, networking and data collection solutions to the embedded, industrial, and digital-out-of-home market sectors.

US

sales@assured-systems.com

Sales: +1 347 719 4508
Support: +1 347 719 4508

1309 Coffeen Ave
Ste 1200
Sheridan
WY 82801
USA

EMEA

sales@assured-systems.com

Sales: +44 (0)1785 879 050
Support: +44 (0)1785 879 050

Unit A5 Douglas Park
Stone Business Park
Stone
ST15 0YJ
United Kingdom

VAT Number: 120 9546 28
Business Registration Number: 07699660