

W24L100-PTA2

23.8" Multi-Touch Chassis Display



KEY FEATURES

- 23.8" 1920 x 1080 Resolution
- VGA input and HDMI input
- Stylish and elegant design
- Front IP65



SPECIFICATIONS

Display			
Resolution	1920x1080	Size	23.8 inches
Contrast Ratio	3000:1	Panel Brightness	250.0 nits
Display Color	16.7M Colors	View Angles	89,89,89,89
Active Area	527.04x296.46 mm	Touch / Glass	Projected Capacitive Multi Touch Screen
Environment			
Operating Humidity	10% to 90% RH, Non-Condensing	Operating Temperature	0°C to 50°C
Storage Temperature	-10°C to 60°C	IP rating	Front IP65
Certification			
Certification	CE, FCC		
IO Ports			
USB Port	1 x USB for Touch Screen	Video	1 x VGA 1 x HDMI (Optional) 1 x DVI (Optional)
Audio	2 x Speaker (Optional)		
Mechanical			
Dimension	588 x 358 x 60 mm	Mounting	VESA Mount
Enclosure	Plastic	Cooling System	Fanless Design
Accessory			
Accessory	1 x VGA cable 1 x HDMI cable 100~240V AC to DC Adapter Power Cord Manual VESA screws(Varies by product)	Optional Accessory	Remote Controller (Optional,Varies by product)
Power			
Power Rating	12V DC in 24V DC in (optional)		
Control			
Button	5 Keys: -, +, Power, Esc, Enter		

DIMENSIONS UNIT:MM

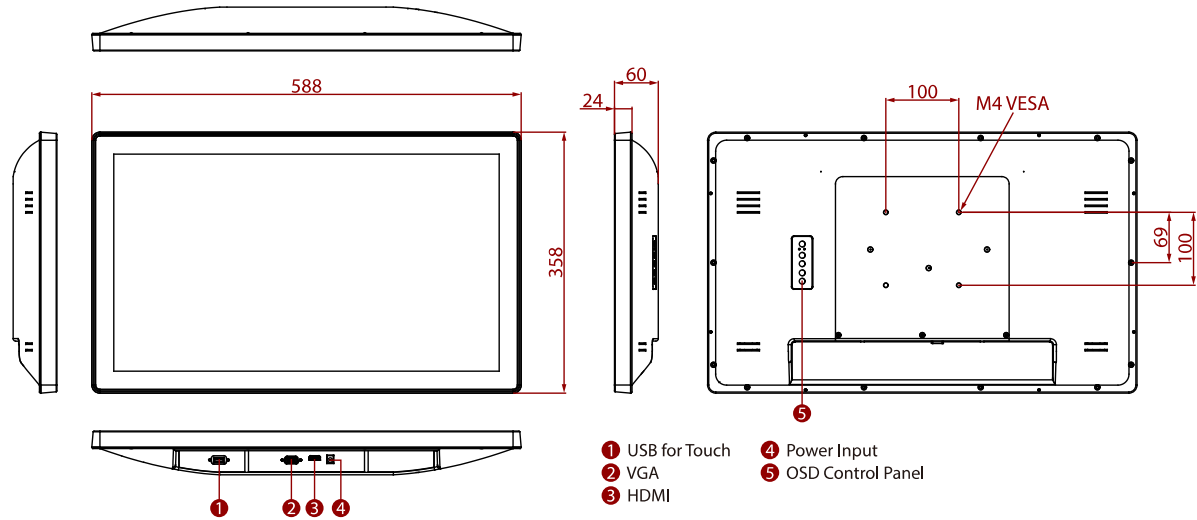

NOTE

1. This is a simplified drawing and some components are not marked in detail.
2. Please contact our sales representative if you need further product information.
3. All specifications are subject to change without prior notice.
4. The product shown in this datasheet is a standard model. For diagrams that contain customized or optional I/O, please contact the Winmate Sales Team for more information.

Assured Systems

Assured Systems is a leading technology company with over 1,500 regular clients in 80 countries, deploying over 85,000 systems to a diverse customer base in 12 years of business. We offer high-quality and innovative rugged computing, display, networking and data collection solutions to the embedded, industrial, and digital-out-of-home market sectors.

US

sales@assured-systems.com

Sales: +1 347 719 4508
Support: +1 347 719 4508

1309 Coffeen Ave
Ste 1200
Sheridan
WY 82801
USA

EMEA

sales@assured-systems.com

Sales: +44 (0)1785 879 050
Support: +44 (0)1785 879 050

Unit A5 Douglas Park
Stone Business Park
Stone
ST15 0YJ
United Kingdom

VAT Number: 120 9546 28
Business Registration Number: 07699660