



10W Single Output Industrial DIN Rail Power Supply

MDR-10 series



■ Features :

- Universal AC input/Full range
- Protections: Short circuit / Overload / Over voltage
- Cooling by free air convection
- Can be installed on DIN rail TS-35/7.5 or 15
- NEC class 2 / LPS compliant
- Built in DC OK active signal
- LED indicator for power on
- No load power consumption<0.75W
- 100% full load burn-in test
- 3 years warranty

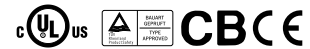

SPECIFICATION

MODEL	MDR-10-5	MDR-10-12	MDR-10-15	MDR-10-24	
OUTPUT	DC VOLTAGE	5V	12V	15V	24V
	RATED CURRENT	2A	0.84A	0.67A	0.42A
	CURRENT RANGE	0 ~ 2A	0 ~ 0.84A	0 ~ 0.67A	0 ~ 0.42A
	RATED POWER	10W	10W	10W	10W
	RIPPLE & NOISE (max.) Note.2	80mVp-p	120mVp-p	120mVp-p	150mVp-p
	VOLTAGE TOLERANCE Note.3	±5.0%	±3.0%	±3.0%	±2.0%
	LINE REGULATION	±1.0%	±1.0%	±1.0%	±1.0%
	LOAD REGULATION	±5.0%	±3.0%	±3.0%	±2.0%
	SETUP, RISE TIME Note.5	500ms, 30ms/230VAC	1000ms, 30ms/115VAC at full load		
HOLD UP TIME (Typ.)	120ms/230VAC	25ms/115VAC at full load			
INPUT	VOLTAGE RANGE	85 ~ 264VAC	120 ~ 370VDC		
	FREQUENCY RANGE	47 ~ 63Hz			
	EFFICIENCY (Typ.)	77%	81%	81%	84%
	AC CURRENT (Typ.)	0.33A/115VAC	0.21A/230VAC		
	INRUSH CURRENT (Typ.)	COLD START 35A/115VAC		70A/230VAC	
	LEAKAGE CURRENT	<1mA / 240VAC			
PROTECTION	OVERLOAD	Above 105% rated output power Protection type : Hiccup mode, recovers automatically after fault condition is removed			
	OVER VOLTAGE	5.75 ~ 6.75V	13.8 ~ 16.2V	17.25 ~ 20.25V	27.6 ~ 32.4V
		Protection type : Shut down o/p voltage, re-power on to recover			
FUNCTION	DC OK ACTIVE SIGNAL (max.)	3.75 ~ 6V / 50mA	9 ~ 13.5V / 40mA	11.5 ~ 16.5V / 40mA	18 ~ 27V / 20mA
ENVIRONMENT	WORKING TEMP.	-20 ~ +70°C (Refer to output load derating curve)			
	WORKING HUMIDITY	20 ~ 90% RH non-condensing			
	STORAGE TEMP., HUMIDITY	-40 ~ +85°C, 10 ~ 95% RH			
	TEMP. COEFFICIENT	±0.03%/°C (0 ~ 50°C)			
SAFETY & EMC (Note 4)	VIBRATION	Component: 10 ~ 500Hz, 2G 10min./1cycle, 60min. each along X, Y, Z axes; Mounting: Compliance to IEC60068-2-6			
	SAFETY STANDARDS	UL508, TUV EN60950-1 approved, NEC class 2 / LPS compliant			
	WITHSTAND VOLTAGE	I/P-O/P:3KVAC	I/P-FG:1.5KVAC	O/P-FG:0.5KVAC	
	ISOLATION RESISTANCE	I/P-O/P, I/P-FG, O/P-FG:100M Ohms/500VDC			
	EMI CONDUCTION & RADIATION	Compliance to EN55011,EN55022 (CISPR22), EN61204-3 Class B			
	HARMONIC CURRENT	Compliance to EN61000-3-2,-3			
OTHERS	EMS IMMUNITY	Compliance to EN61000-4-2, 3, 4, 5, 6, 8, 11, ENV50204, EN55024,EN61000-6-1,EN61204-3, light industry level, criteria A			
	MTBF	584K hrs min. MIL-HDBK-217F (25°C)			
OTHERS	DIMENSION	22.5*90*100mm (W*H*D)			
	PACKING	0.17Kg; 72pcs/13.2Kg/0.91CUFT			
NOTE	1. All parameters NOT specially mentioned are measured at 230VAC input, rated load and 25°C of ambient temperature. 2. Ripple & noise are measured at 20MHz of bandwidth by using a 12" twisted pair-wire terminated with a 0.1uf & 47uf parallel capacitor. 3. Tolerance : includes set up tolerance, line regulation and load regulation. 4. The power supply is considered a component which will be installed into a final equipment. The final equipment must be re-confirmed that it still meets EMC directives. 5. Length of set up time is measured at cold first start. Turning ON/OFF the power supply may lead to increase of the set up time.				



10W Single Output Industrial DIN Rail Power Supply

MDR-10 series

■ Mechanical Specification

Case No. 956 Unit:mm

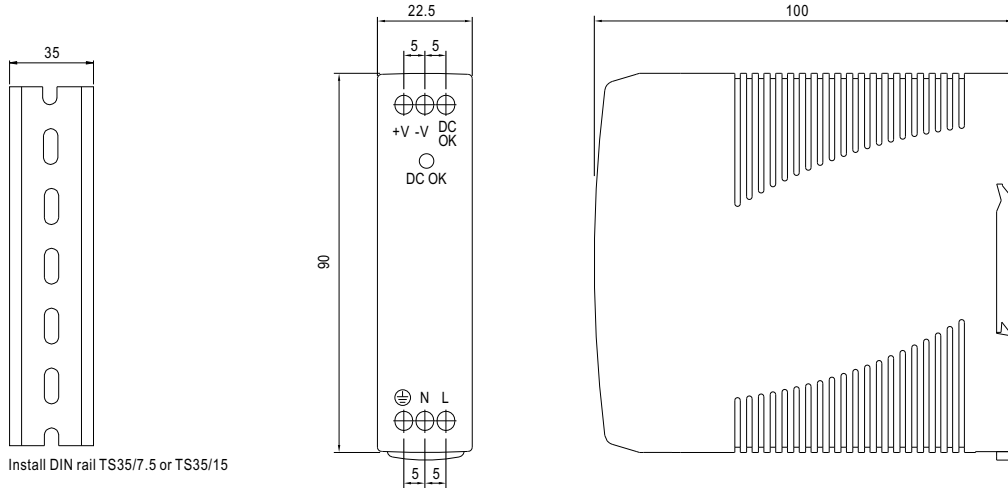

■ Block Diagram

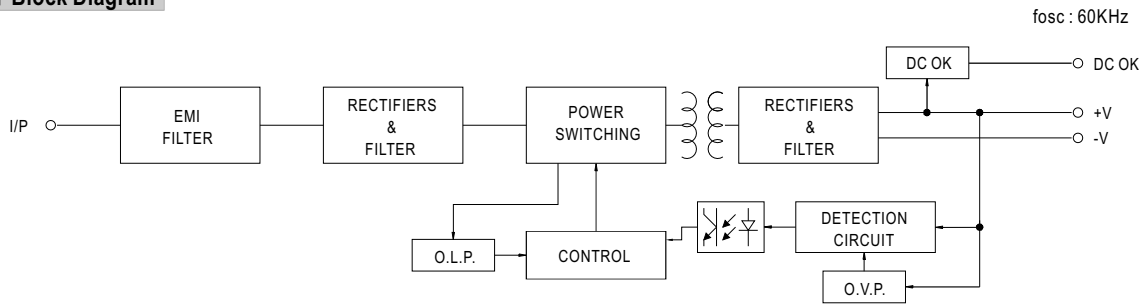

■ Application of DC OK Active Signal

(a) 5V signal

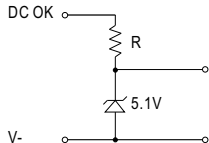

Model	R
5V	≥ 200Ω
12V	≥ 1.5KΩ
15V	≥ 2KΩ
24V	≥ 3.9KΩ

(b) LED

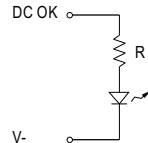

Model	R
5V	≥ 1KΩ
12V	≥ 2.4KΩ
15V	≥ 3KΩ
24V	≥ 4.7KΩ

(c) Relay

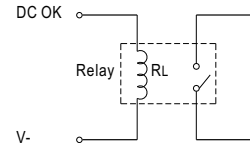

Model	RL
5V	≥ 120Ω
12V	≥ 700Ω
15V	≥ 700Ω
24V	≥ 1.2KΩ

■ Derating Curve

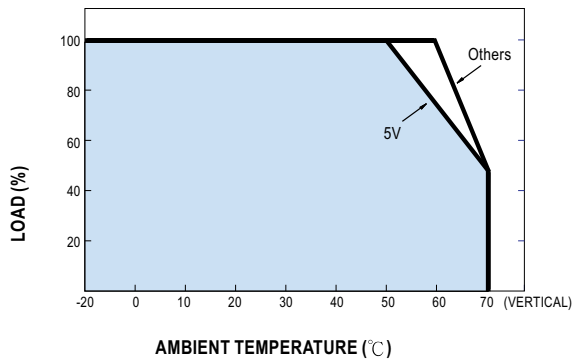

■ Output Derating VS Input Voltage

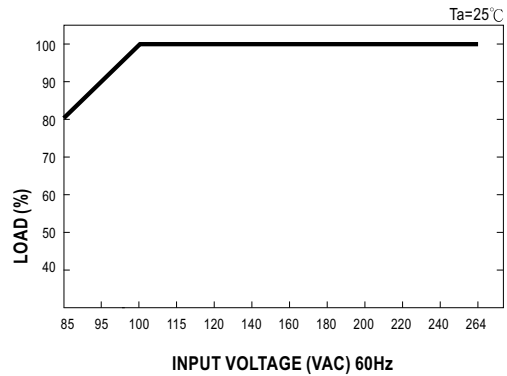

Assured Systems

Assured Systems is a leading technology company with over 1,500 regular clients in 80 countries, deploying over 85,000 systems to a diverse customer base in 12 years of business. We offer high-quality and innovative rugged computing, display, networking and data collection solutions to the embedded, industrial, and digital-out-of-home market sectors.

US

sales@assured-systems.com

Sales: +1 347 719 4508
Support: +1 347 719 4508

1309 Coffeen Ave
Ste 1200
Sheridan
WY 82801
USA

EMEA

sales@assured-systems.com

Sales: +44 (0)1785 879 050
Support: +44 (0)1785 879 050

Unit A5 Douglas Park
Stone Business Park
Stone
ST15 0YJ
United Kingdom

VAT Number: 120 9546 28
Business Registration Number: 07699660