

# EC900-8MM/EC910-8MM NXP i.MX8M Mini Processor Ultra Small Size Embedded System

## KEY FEATURES



### NXP i.MX8M Mini Platform

Quad Core Max.1.8GHz



### High Speed Memory Down

LPDDR4 3200MHz

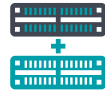

### Multiple Expansions

M.2 support, WiFi/BT, LTE



### Rich I/O

2 GbE LAN, 2 USB, 4bit DIO, RS422, RS485



### Wide Voltage

Support 9~36VDC

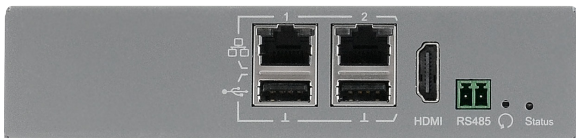

Photo for EC900-8MM



## PANEL

### EC900-8MM



Front View



Rear View

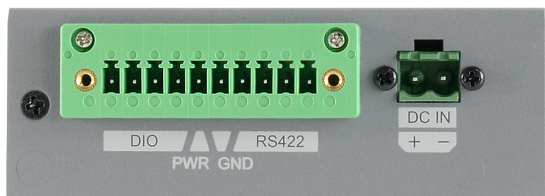

Left View

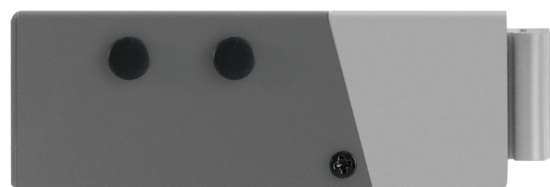

Right View

**PANEL**

**EC910-8MM**

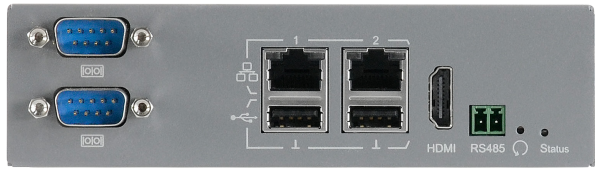

**Front View**



**Rear View**

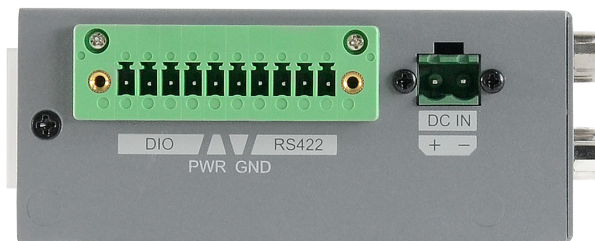

**Left View**

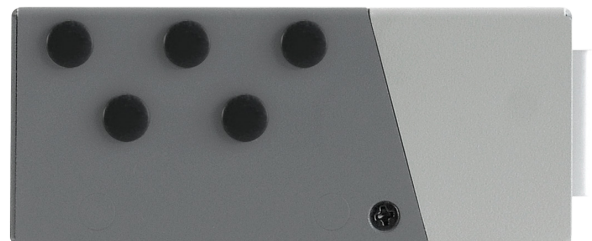

**Right View**

**DIMENSIONS**

**EC900-8MM**

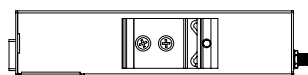

**Front View**

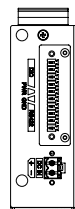

**Left View**

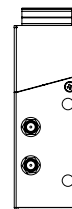
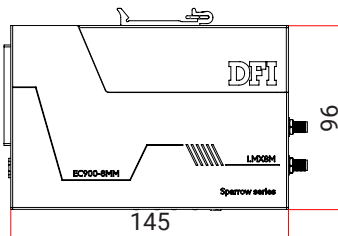

**Right View**

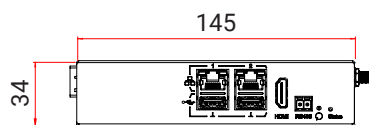

**Rear View**

**DIMENSIONS**

**EC910-8MM**

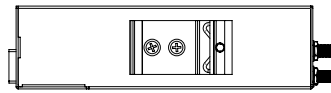

**Front View**

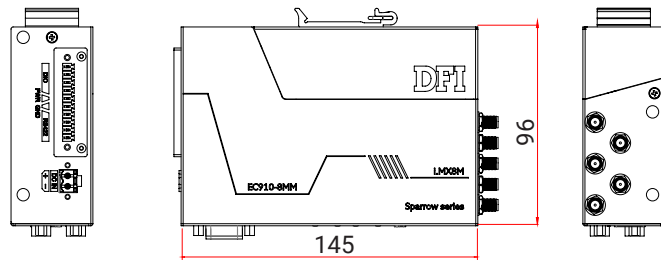

**Left View**

**Right View**

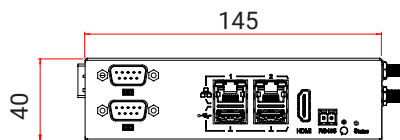

**Rear View**

**DIN RAIL MOUNTING**

**EC900-8MM**

**EC910-8MM**

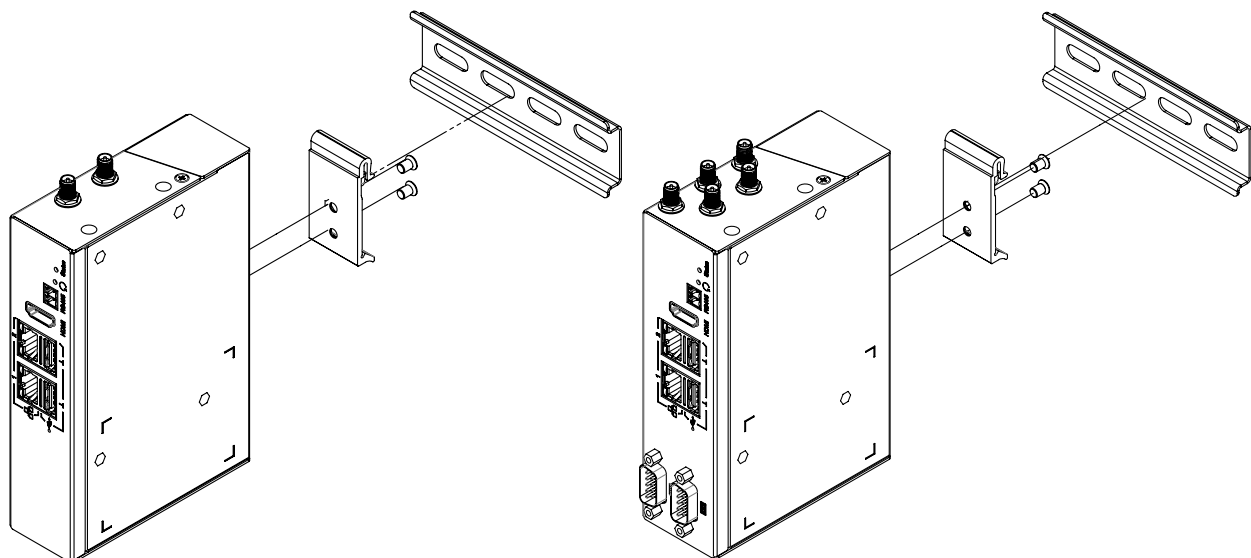

**SPECIFICATION**



Model Name	EC900-8MM		EC910-8MM
Platform	ARM		
SYSTEM	Processor	I.MX8M mini Quad core, VPU/HDR10/GPU,1.6/1.8Ghz, Commercial temp	
	Memory	LPDDR4 die size, up to 8GB (Default 1GB & 4GB)	
DISPLAY	Display	1 x HDMI, HDMI: resolution up to 1920x1080 @ 60 Hz	
	Single Display	HDMI	
STORAGE	External / Internal	eMMC up to 64GB (Default 8GB) Micro-SD Card Socket	
EXPANSION	Interface	1 x M.2 E key 2230 (USB) 1 x M.2 B key 3042/2242 (USB) 1 x Nano SIM slot	
ETHERNET	Controller	1 x ATHEROS Ethernet Controller RTL8211 (10/100/1000Mbps) 1 x Ethernet Controller (10/100/1000Mbps)	
LED	Indicators	1 x Status LED	
I/O	Ethernet	2 x GbE (RJ-45)	
	Serial	1 x RS-485 (Via terminal block) 1 x RS-422 (Via terminal block)	1 x RS-485 (Via terminal block) 1 x RS-422 (Via terminal block) 2 x RS-232 (DB9)
	USB	2 x USB 2.0 (type A)	
	Display	1 x HDMI	
	Button	1 x Power Reset Button	
	Wi-Fi Antenna	2 x Antenna Hole	6 x Antenna Hole
	DIO	4-bit DIO (Via terminal block)	
INTERNAL I/O	USB	1 x USB 2.0 1 x OTG USB Type C	
	Serial	2 x RS-232	-
WATCHDOG TIMER	Output & Interval	System Reset, Programmable via Software from 1 to 255 Seconds	
SECURITY	TPM	TPM 2.0/TrustZone(Opt.)	
POWER	Type	Wide Range 9~36V	
	Connector	Via Terminal Block	
	Consumption	Idle : 4.6W, Max : 6.4W	
OS SUPPORT	Os Support	Yocto 3.3, Kernel 5.10.72	
MECHANISM	Construction	Sheet Metal	
	Mounting	DIN Rail Mount	
	Dimensions (W x H x D)	145mm x 34mm x 96mm	145mm x 40mm x 96mm
	Weight	0.45kg	0.55kg
ENVIRONMENT	Operating Temperature	-5 to 60°C -40 to 70°C (available upon request)	
	Storage Temperature	-40 to 85°C	
	Relative Humidity	10 to 95% RH (non-condensing)	
STANDARDS AND CERTIFICATIONS	Shock	Operating: 3G, 11ms Non-Operating: 5G, 11ms	
	Vibration	Operating: Random 5~500Hz, IEC68-2-64 (3G) Non-Operating: Sine 10~500Hz, IEC68-2-6 (3G)	
	Certification	CE, FCC Class A, UKCA, RoHS	

## ORDERING INFORMATION

Model Name	Part Number	Op. Temp.	On board Memory LPDDR4	Storage eMMC	Display	LAN	USB 2.0	RS-485	RS-422	RS-232	DIO	Security	OS
EC900-8MM	750-EC9001-000G	-5~60°C	1GB	8GB	1 HDMI	2 GbE	2	2-pole	4-pole	NA	4-pole	-	Yocto 3.3 (Kernel 5.10)
EC900-8MM	750-EC9001-200G	-5~60°C	4GB	8GB	1 HDMI	2 GbE	2	2-pole	4-pole	NA	4-pole	-	Yocto 3.3 (Kernel 5.10)
EC900-8MM	750-EC9001-500G	-40~70°C	4GB	8GB	1 HDMI	2 GbE	2	2-pole	4-pole	NA	4-pole	-	Yocto 3.3 (Kernel 5.10)
EC910-8MM	750-EC9101-000G	-5~60°C	1GB	8GB	1 HDMI	2 GbE	2	2-pole	4-pole	2 DB9	4-pole	-	Yocto 3.3 (Kernel 5.10)
EC910-8MM	750-EC9101-100G	-5~60°C	4GB	8GB	1 HDMI	2 GbE	2	2-pole	4-pole	2 DB9	4-pole	-	Yocto 3.3 (Kernel 5.10)
EC910-8MM	750-EC9101-400G	-40~70°C	2GB	8GB	1 HDMI	2 GbE	2	2-pole	4-pole	2 DB9	4-pole	-	Yocto 3.3 (Kernel 5.10)
EC910-8MM	750-EC9101-500G	-40~70°C	4GB	8GB	1 HDMI	2 GbE	2	2-pole	4-pole	2 DB9	4-pole	-	Yocto 3.3 (Kernel 5.10)
EC910-8MM	750-EC9101-600G	-40~70°C	4GB	8GB	1 HDMI	2 GbE	2	2-pole	4-pole	2 DB9	4-pole	TPM 2.0/TrustZone	Yocto 3.3 (Kernel 5.10)

## OPTIONAL ITEMS

Optional Items	Part Number	Description
Power Adapter	671-102002-000G	POWER ADAPTER 100~240V 24V/1A 24W 100x45x31mm L=1500mm(EDAC) EA1024J1 (03) LV6 RoHS
	671-102501-000G	POWER ADAPTER 25W; GST25A24; Input:100~240V; Output:24Vdc/1.04A; 93x54x36mm L=1800mm Stripped and tinned leads; LV6; GST25A24-DFI(MEAN WELL)RoHS
Power Cord	785-PWRD	Standard (USA/EUR/CH...) Power Cord
WiFi/BT module	612-RTL882-000G	Wi-Fi+BT(V5.0+LE and BR/EDR) M.2 2230 Combo Module Card RTL8822CE(ENLI)RoHS

## PACKING LIST

1 System unit
1 10-Pole Terminal Block for RS-422/4-bit DIO
1 2-Pole Terminal Block for RS-485
1 2-Pole Terminal Block for Power Input
1 DIN Rail Bracket/Screw Pack
1 Quick Installation Guide

## Assured Systems

Assured Systems is a leading technology company with over 1,500 regular clients in 80 countries, deploying over 85,000 systems to a diverse customer base in 12 years of business. We offer high-quality and innovative rugged computing, display, networking and data collection solutions to the embedded, industrial, and digital-out-of-home market sectors.

### US

[sales@assured-systems.com](mailto:sales@assured-systems.com)

Sales: +1 347 719 4508  
Support: +1 347 719 4508

1309 Coffeen Ave  
Ste 1200  
Sheridan  
WY 82801  
USA

### EMEA

[sales@assured-systems.com](mailto:sales@assured-systems.com)

Sales: +44 (0)1785 879 050  
Support: +44 (0)1785 879 050

Unit A5 Douglas Park  
Stone Business Park  
Stone  
ST15 0YJ  
United Kingdom

VAT Number: 120 9546 28  
Business Registration Number: 07699660