

EC510-ADS/EC511-ADS

12th Gen Intel® Core™
Modular-Designed Embedded System

Q670E



KEY FEATURES



DDR4

DDR4 SODIMM up to 64GB



PoE

Support up to 4 PoE (EC51x-ADS62GA6E-Q)



Three Independent Displays

1 VGA + 2 HDMI/DP++ (auto detection)



Support 5G Communication

Support 5G communication

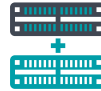

Multiple Expansion

3 M.2 and 1 PCIe or 1 PCI



Wide-Temperature

Operating Temperature: -20 to 60°C



PANEL

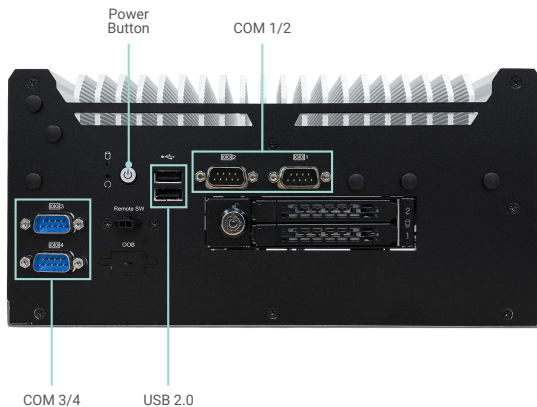

Front View

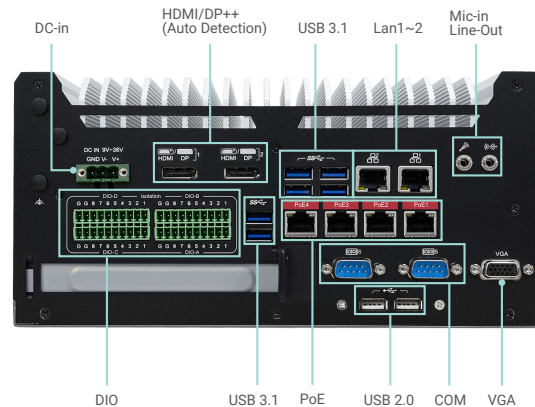

Rear View
EC51x-ADS62GA6E-Q

PANEL

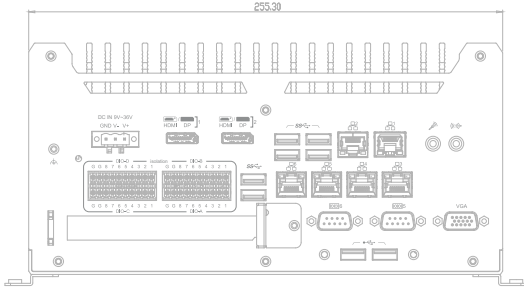

Rear View
EC51x-ADS62GA6-Q

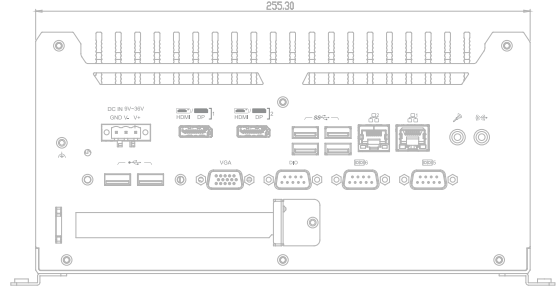

Rear View
EC51x-ADS6881-Q

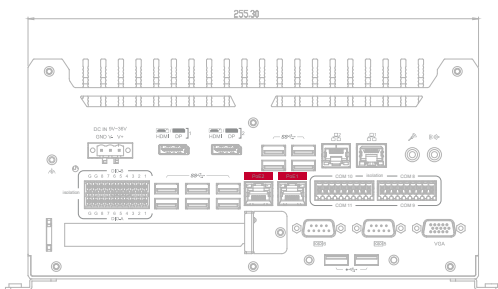

Rear View
EC51x-ADSAGE4E-Q

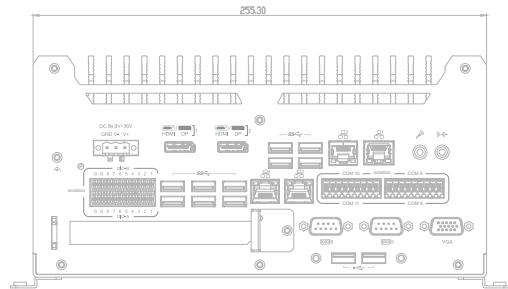

Rear View
EC51x-ADSAGE4-Q

DIMENSIONS

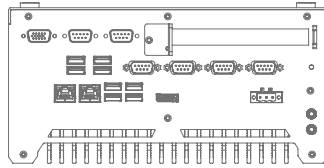

Front View

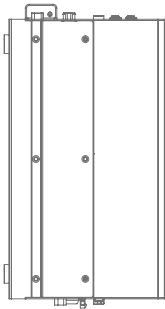

Left View

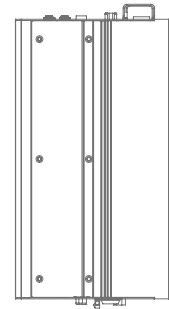
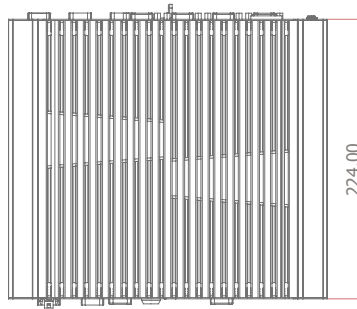

Right View

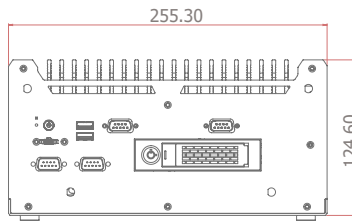

Rear View

WALL MOUNTING

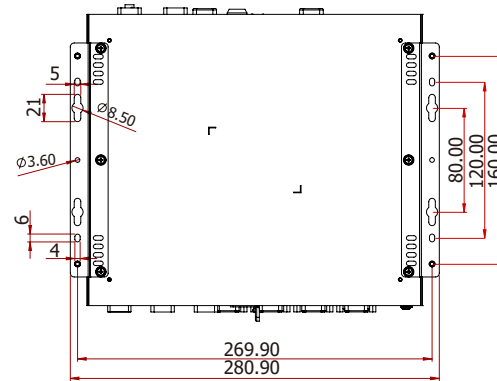
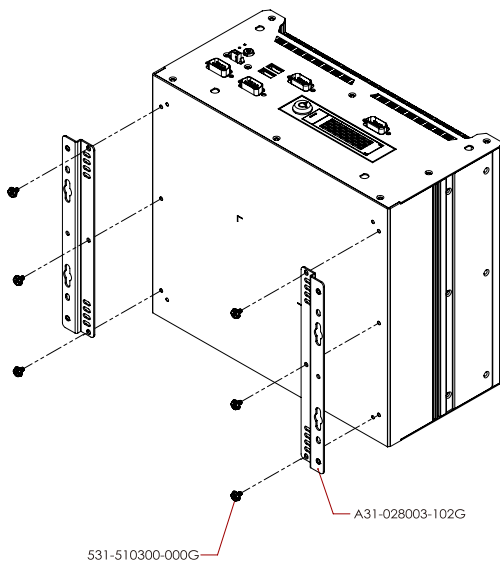

SPECIFICATION

SYSTEM	Processor	12th Generation Intel® Core™ Processors, LGA 1700 Intel® Core™ i9-12900TE (16 Cores, 30M Cache, up to 4.8GHz); 35W Intel® Core™ i7-12700TE (12 Cores, 25M Cache, up to 4.6GHz); 35W Intel® Core™ i5-12500TE (6 Cores, 18M Cache, up to 4.3GHz); 35W Intel® Core™ i3-12100TE (4 Cores, 12M Cache, to 4GHz); 35W Intel® Pentium® G7400TE (2 Cores, 6M Cache, 3GHz); 35W Intel® Celeron® G6900TE (2 Cores, 4M Cache, 2.4GHz); 35W	
	Chipset	Intel® Q670E Chipset	
	Memory	Two 260-pin DDR4 2400/2666MHz SODIMM up to 64GB	
	BIOS	AMI SPI 128Mbit	
GRAPHICS	Controller	Intel® HD Graphics	
	Feature	OpenGL up to 5.0, DirectX 11, OpenCL 2.1 HW Decode: HEVC/H.265, H.264, M/JPEG, MPEG2, VC1/WMV9, VP8 (8-bit), VP9 (10-bit) HW Encode: HEVC/H.265, M/JPEG, MPEG2, VP8	
	Display	1 x VGA 2 x HDMI/DP++ (auto detection)	VGA: resolution up to 1920x1200 @ 60Hz HDMI: resolution up to 4096x2160 @ 30Hz DP++: resolution up to 4096x2304 @ 60Hz
	Triple Displays	1 VGA + 2 HDMI/DP++ (auto detection)	
STORAGE	Interface	2 x 2.5" SATA 3.0 drive bay (Support RAID 0/1)	
EXPANSION	Interface	[EC510-ADS Series] 1 x M.2 2230 E key (PCIe/USB 2.0) 1 x M.2 2280 M key (PCIe x4 NVMe) 1 x M.2 3042/3052 B key (PCIe/USB 3.0) 1 x PCI slot	
		[EC511-ADS Series] 1 x M.2 2230 E key (PCIe/USB 2.0) 1 x M.2 2280 M key (PCIe x4 NVMe) 1 x M.2 3042/3052 B key (PCIe/USB 3.0) 1 x PCIe x16 slot	
AUDIO	Audio Codec	ALC888	
ETHERNET	Controller	2 x Intel® i225-IT	
LED	Indicators	1 x Status LED 1 x HDD LED	
FRONT I/O	Serial	4 x RS-232/422/485 (DB-9)	
	USB	2 x USB 2.0 (type A)	
	Buttons	1 x Power button 1 x Reset button	
	Antenna	6 x Antenna hole (WiFi)	

SPECIFICATION

REAR I/O	Ethernet/PoE	-EC51x-ADS62GA6E-Q 2 x GbE (RJ-45) 4 x PoE (RJ-45)	-EC51x-ADSAGE4E-Q 2 x GbE (RJ-45) 2 x PoE (RJ-45)
		-EC51x-ADS62GA6-Q 6 x GbE (RJ-45)	-EC51x-ADSAGE4-Q 4 x GbE (RJ-45)
		-EC51x-ADS6881-Q 2 x GbE (RJ-45)	
	Serial	-EC51x-ADS62GA6E-Q/ADS62GA6-Q/ADS6881-Q 2 x RS232	
		-EC51x-ADSAGE4E-Q/ADSAGE4-Q 4 x RS232/422/485 (w/ isolation 2KV) 2 x RS232	
	USB	-EC51x-ADS62GA6E-Q/ADS62GA6-Q 6 x USB 3.1 (Gen2) 2 x USB 2.0	-EC51x-ADSAGE4E-Q/ADSAGE4-Q 10 x USB 3.1 (Gen2) 2 x USB 2.0
		-EC51x-ADS6881-Q 4 x USB 3.1 (Gen2) 2 x USB 2.0	
	DIO	-EC51x-ADS62GA6E-Q/ADS62GA6-Q 32 bits DIO (w/ isolation 2KV)	-EC51x-ADSAGE4E-Q/ADSAGE4-Q 16 bits DIO (w/ isolation 2KV)
		-EC51x-ADS6881-Q 8 bits DIO	
	Display	1 x VGA 2 x HDMI/DP++ (auto detection)	
Audio	1 x Line-out 1 x Mic-in		
WATCHDOG TIMER	Output & Interval	System reset, programmable via software from 1 to 255 seconds	
SECURITY	TPM	TPM 2.0	
POWER	Type	Wide range 9~36V	
	Connector	3-pole terminal block 2-pin power remote switch connector	
OS SUPPORT	OS Support	Windows 10 IoT Enterprise 64 Bit Linux (available upon request)	
ENVIRONMENT	Operating Temperature	-20 to 60°C (2.5" SSD or M.2 SSD)	
	Storage Temperature	-20 to 85°C	
	Relative Humidity	5 to 95% RH (non-condensing)	
MECHANICAL	Construction	Metal + Aluminum	
	Mounting	Wall mount	
	Dimensions (W x H x D)	255.3 x 124.6 x 224mm	
	Weight	5.1 kg	
STANDARDS AND CERTIFICATIONS	Shock	Half sine wave 3G, 11ms, 3 shock per axis	
	Vibration	IEC 60068-2-64	
	Certifications	CE, FCC Class A, UKCA, RoHS, BIS	

Assured Systems

Assured Systems is a leading technology company with over 1,500 regular clients in 80 countries, deploying over 85,000 systems to a diverse customer base in 12 years of business. We offer high-quality and innovative rugged computing, display, networking and data collection solutions to the embedded, industrial, and digital-out-of-home market sectors.

US

sales@assured-systems.com

Sales: +1 347 719 4508

Support: +1 347 719 4508

1309 Coffeen Ave
Ste 1200
Sheridan
WY 82801
USA

EMEA

sales@assured-systems.com

Sales: +44 (0)1785 879 050

Support: +44 (0)1785 879 050

Unit A5 Douglas Park
Stone Business Park
Stone
ST15 0YJ
United Kingdom

VAT Number: 120 9546 28

Business Registration Number: 07699660