



Industrial Solutions Partner!

SSF/SSH3585-Y V1

35.8" TFT LCD, 1000 nits LED Backlight , 1920x532 ultra-wide aspect ratio 16:4.4

The SSF/SSH3585-Y is a 35.8 inch color TFT-LCD display with special aspect ratio 16:4.4 and wide resolution 1920 x 532. It is Litemax's Spanpixel series product which designed for high brightness 1000 nits with power efficiency LED backlight. It provides LCD panel with specific aspect ratios and sunlight readable for digital signage, public transportation, exhibition hall, department store, and vending machine.

Key Features

- 35.8" Stretched LCD
- Ultra-Wide Screen (16 : 4.4)
- High Brightness 1000 nits
- LED Backlight
- Low Power Consumption
- BL MTBF: 50,000 hours

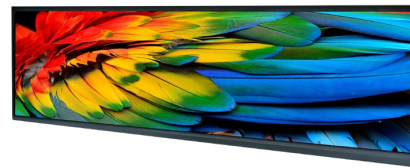

Specifications

Model Name	SSF/SSH3585-Y V1
Description	35.8" TFT LCD, 1000 nits LED backlight, 1920x532
Screen Size	35.8"
Display Area (mm)	878.112(H) x 239.081(V)
Brightness	1000 cd/m ²
Resolution	1920x532
Aspect Ratio	16 : 4.4
Contrast Ratio	4200 : 1
Pixel Pitch (mm)	0.45735(H) x 0.4494(V)
Pixel Pre Inch (PPI)	55
Viewing Angle	178°(H),178°(V)
Color Saturation (NTSC)	81%
Display Colors	16.7M
Response Time (Typical)	9.5ms
Panel Interface	LVDS
Input Interface	VGA,DVI-D,HDMI,DP
Input Power	DC 24V
Power Consumption	56W, 60W (with AD board)
OSD Key	4 Keys (Power Switch, Menu, +, -)
OSD Control	Brightness, Color, Contrast, Auto Turing, H/V Position...etc
Dimensions (mm)	895.51(H) x 265.68(V) x 31.1 (T)
Bezel Size(U/B/L/R)	11.9/11.9/7.3/7.3 mm
Weight (Net)	4.8kg
Operating Temperature	0 °C ~ 50 °C
Storage Temperature	-20 °C ~ 60 °C

SSF= Panel + LED Driving Board

SSH= Panel + LED Driving Board + AD Control Board

Specifications are subject to change without notice.
All brands or product names are trademarks or registered trademarks of their respective companies.



Industrial Solutions Partner!

Mechanical Drawing

Outline Dimensions

Unit:mm

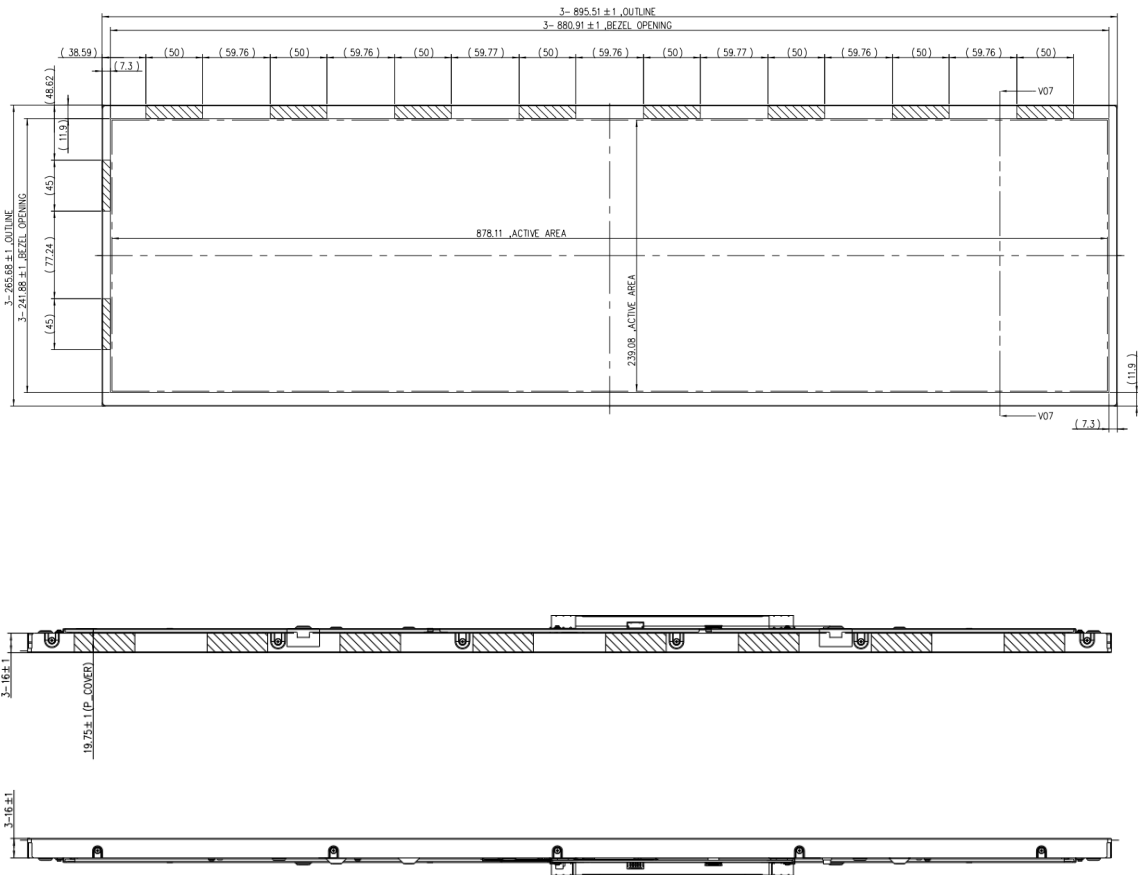

NOTES:

1. UNLESS OTHERWISE SPECIFY TOLERANCE IS ± 1.0 mm.
2. SYSTEM INTEGRATION COMPANY MUST KEEP MODULE UP AND DOWN DIRECTION ON THE DRAWING TO DESIGN TV SET.
3. : SUGGEST MOUNTING AREA POSITION, NO MARK AREA CAN'T BE CLIPPED.
4. : COF POSITION (SI MECHANICAL STRUCTURE SHOULD NOT TOUCH THE POSITIONS OF COF).
5. SCREW HOLES TYPE:
 SCREW A: M3, PITCH=0.5/MACHINE, MAX. TORQUE=6 KGF-CM, MAX. DEPTH= 2.5 mm.
 SCREW B: M3, PITCH=0.5/MACHINE, MAX. TORQUE=6 KGF-CM, MAX. DEPTH= 5 mm.
6. STANDOFF TYPE :
 STANDOFF A: M3, PITCH=0.5/MACHINE, MAX. TORQUE=30 KGF-CM, MAX. DEPTH=5mm.
7. THE WIRE AND FFC CABLES OF THE SYSTEM INTEGRATION COMPANY CAN'T OVERLAP THE SCREW HOLES OF THE REAR COVER.
8. THE WIRE AND FFC CABLES OF THE SYSTEM INTEGRATION COMPANY CAN'T BE UNDER THE POWER PCBA.

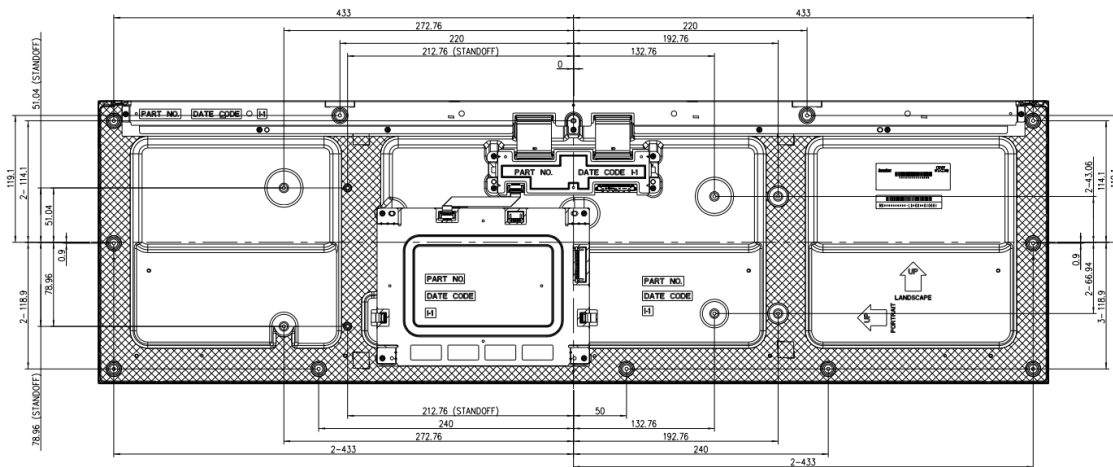
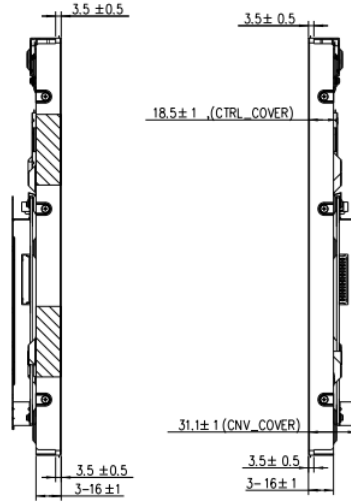

- NOTES:
- UNLESS OTHERWISE SPECIFY TOLERANCE IS ±1.0mm.
 - SYSTEM INTEGRATION COMPANY MUST KEEP MODULE UP AND DOWN DIRECTION ON THE DRAWING TO DESIGN TV SET.
 - "": SUGGEST MOUNTING AREA POSITION, NO MARK AREA CAN'T BE CLIPPED.
 - "": COF POSITION (SI MECHANICAL STRUCTURE SHOULD NOT TOUCH THE POSITIONS OF COF).
 - SCREW HOLES TYPE:
SCREW A: M3, PITCH=0.5/MACHINE, MAX. TORQUE=6 KGF-CM, MAX. DEPTH= 2.5 mm.
SCREW B: M3, PITCH=0.5/MACHINE, MAX. TORQUE=6 KGF-CM, MAX. DEPTH= 5 mm.
 - STANDOFF TYPE :
STANDOFF A: M3, PITCH=0.5/MACHINE, MAX. TORQUE=30 KGF-CM, MAX. DEPTH=5mm.
 - THE WIRE AND FFC CABLES OF THE SYSTEM INTEGRATION COMPANY CAN'T OVERLAP THE SCREW HOLES OF THE REAR COVER.
 - THE WIRE AND FFC CABLES OF THE SYSTEM INTEGRATION COMPANY CAN'T BE UNDER THE POWER PCBA.

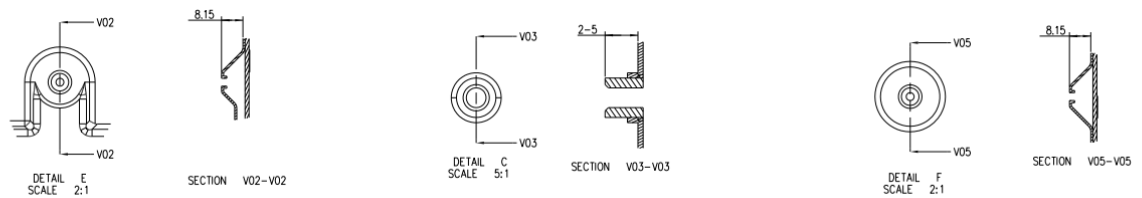
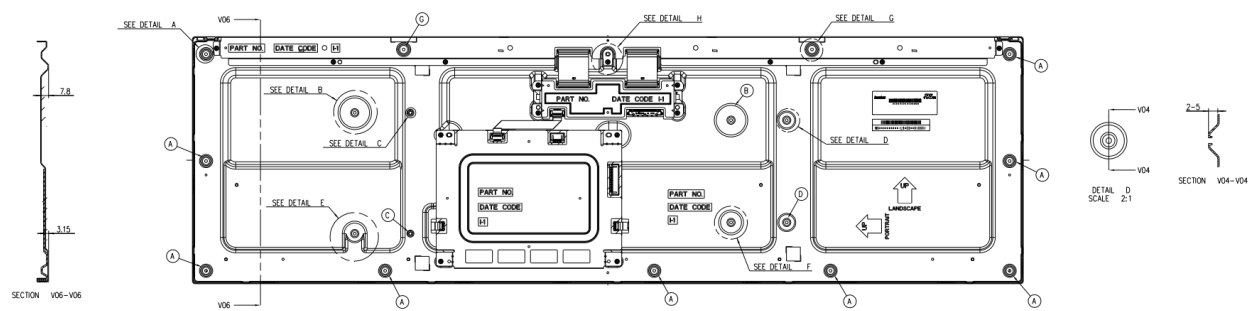
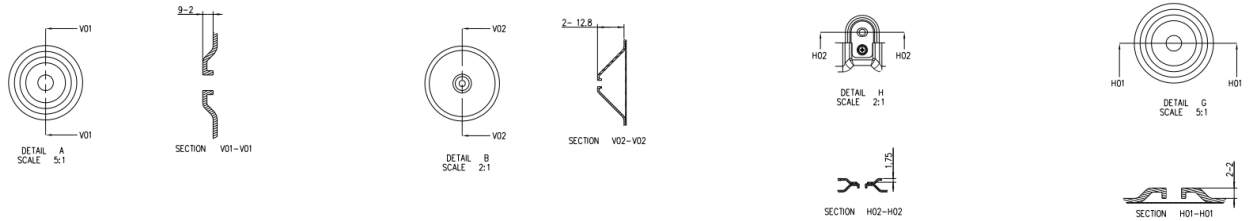

- NOTES:
- UNLESS OTHERWISE SPECIFY TOLERANCE IS $\pm 1.0\text{mm}$.
 - SYSTEM INTEGRATION COMPANY MUST KEEP MODULE UP AND DOWN DIRECTION ON THE DRAWING TO DESIGN TV SET.
 - "": SUGGEST MOUNTING AREA POSITION, NO MARK AREA CAN'T BE CLIPPED.
 - "": COF POSITION (SI MECHANICAL STRUCTURE SHOULD NOT TOUCH THE POSITIONS OF COF).
 - SCREW HOLES TYPE:
 SCREW A: M3, PITCH=0.5/MACHINE, MAX. TORQUE=6 KGF-CM, MAX. DEPTH= 2.5 mm.
 SCREW B: M3, PITCH=0.5/MACHINE, MAX. TORQUE=6 KGF-CM, MAX. DEPTH= 5 mm.
 - STANDOFF TYPE :
 STANDOFF A: M3, PITCH=0.5/MACHINE, MAX. TORQUE=30 KGF-CM, MAX. DEPTH=5mm.
 - THE WIRE AND FFC CABLES OF THE SYSTEM INTEGRATION COMPANY CAN'T OVERLAP THE SCREW HOLES OF THE REAR COVER.
 - THE WIRE AND FFC CABLES OF THE SYSTEM INTEGRATION COMPANY CAN'T BE UNDER THE POWER PCBA.

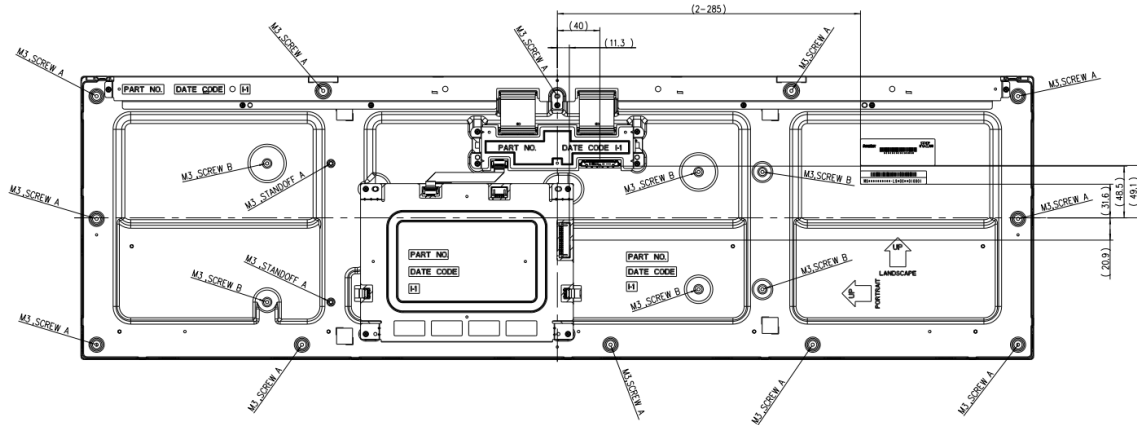

NOTES:

1. UNLESS OTHERWISE SPECIFY TOLERANCE IS $\pm 1.0\text{mm}$.
2. SYSTEM INTEGRATION COMPANY MUST KEEP MODULE UP AND DOWN DIRECTION ON THE DRAWING TO DESIGN TV SET.
3. "☒": SUGGEST MOUNTING AREA POSITION, NO MARK AREA CAN'T BE CLIPPED.
4. "☒": COF POSITION (SI MECHANICAL STRUCTURE SHOULD NOT TOUCH THE POSITIONS OF COF).
5. SCREW HOLES TYPE:
 SCREW A: M3, PITCH=0.5/MACHINE, MAX. TORQUE=6 KGF-CM, MAX. DEPTH= 2.5 mm.
 SCREW B: M3, PITCH=0.5/MACHINE, MAX. TORQUE=6 KGF-CM, MAX. DEPTH= 5 mm.
6. STANDOFF TYPE :
 STANDOFF A: M3, PITCH=0.5/MACHINE, MAX. TORQUE=30 KGF-CM, MAX. DEPTH=5mm.
7. THE WIRE AND FFC CABLES OF THE SYSTEM INTEGRATION COMPANY CAN'T OVERLAP THE SCREW HOLES OF THE REAR COVER.
8. THE WIRE AND FFC CABLES OF THE SYSTEM INTEGRATION COMPANY CAN'T BE UNDER THE POWER PCBA.



Industrial Solutions Partner!

Ordering Information

Part Number	Description
SSF3585-YNN-A11	35.8", 1000nits, 1920x532, LID on LCM, 3in1, V1
SSH3585-YNN-J11	35.8", 1000nits, 1920x532, LID on LCM, AD5827GDHP, DC24V, 3in1, V1

Optional Accessories

Part Number	Description
840613141200	ADAPTER, AC/DC, 24V/7.5A, 180W, FSP180-AAAN3, Power-Din, P
810618301010	CABLE, POWER, AC, 1830mm USA type
810618301090	CABLE, POWER, AC, 1830mm Europe type
810618301050	CABLE, POWER, AC, 1830mm UK type
810618301170	CABLE, POWER, AC, 1830mm Australia type
810618301031	CABLE, POWER, AC, 1830mm Japan type

Customer request

Touch	SCT (Single-Touch), PCT (Multi-Touch)
Glass	Tempered glass, AR coating.....

Assured Systems

Assured Systems is a leading technology company with over 1,500 regular clients in 80 countries, deploying over 85,000 systems to a diverse customer base in 12 years of business. We offer high-quality and innovative rugged computing, display, networking and data collection solutions to the embedded, industrial, and digital-out-of-home market sectors.

US

sales@assured-systems.com

Sales: +1 347 719 4508
Support: +1 347 719 4508

1309 Coffeen Ave
Ste 1200
Sheridan
WY 82801
USA

EMEA

sales@assured-systems.com

Sales: +44 (0)1785 879 050
Support: +44 (0)1785 879 050

Unit A5 Douglas Park
Stone Business Park
Stone
ST15 0YJ
United Kingdom

VAT Number: 120 9546 28
Business Registration Number: 07699660