

U.K. ☎ +44 1785 879050 U.S. ☎ +1 347 7194508 www.assured-signage.com

Sureview 43" Android PCAP Touch Screens



Perfect for interactive experiences, such as wayfinding and product browsing

Ultra Responsive Interactivity

Optimum sensitivity to touch gestures and rapid response times ensure that users have a smooth, effortless experience. There's no need to touch the same thing multiple times or wait for a touch to register when interacting with these ultra-responsive displays.













Giant Tablet Styling

The tempered edge-to-edge glass face, rounded corners, super slim depth, aluminium surround and thin black border give a captivating tablet-like aesthetic. This stylish glass face also increases the durability of the display, protecting the LCD panel and other internal components from potential damage in public spaces.



Concave Indent Profile

-  24/7 Commercial Grade
-  Integrated Android Media Player
-  10-Point PCAP Touch
-  Surface Plasma Treatment
-  Lightweight Design
-  450cd/m² IPS Panel
-  Touch Screen Monitor
-  Free Wall Mount
-  Integrated Speakers
-  3 Year Commercial Warranty

SUREVIEW

Other Features

24/7 Commercial Use

These displays are able to be in constant use 24/7 for over 70,000 hours thanks to their commercial grade LCD panel, media player and other components. They also have no external buttons or controls to prevent tampering.



10-Point PCAP Touch

Having up to 10 touch points allows users to perform a variety of touch gestures, including manipulating images and zooming in/out – much like you would with a domestic tablet or smart phone. It also allows multiple users to interact with the screen at the same time.



Surface Plasma Treatment

A special oleophobic coating makes the glass front more resistant to the oily residue left by fingerprints and improves the smoothness of touch gestures. Unlike other touch screens on the market, this glass is not etched, which vastly enhances the optical clarity.

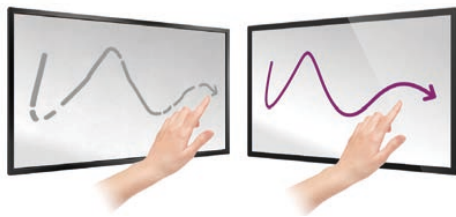

Lightweight Design

With a robust but lightweight aluminium enclosure and moulded polymer rear, these displays are over 30% lighter than their predecessor, allowing for easier installation and maintenance.



450cd/m² IPS Panel

Thanks to the commercial grade IPS technology, these panels are designed to accurately display image quality and colour depth with no fall-off in colour accuracy, as well as achieving ultimate lifelike colour temperature in both landscape and portrait orientations.



Touch Screen Monitor

Connect to an external source, such as a third-party PC or media player, using the built-in USB and HDMI or VGA/3.5mm audio inputs to use the display as touch screen monitor. This increases the versatility of applications that can be run.

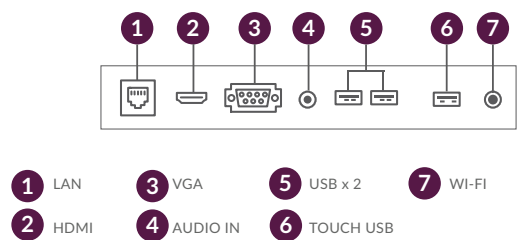

Content Management System

Quickly and easily create your own interactive content by utilising our user-friendly CMS, which can be packaged with the display for a small charge.



Free Wall Mount

A super slim wall mount is included at no extra cost, enabling you to install your screen in either landscape or portrait orientation with a secure and aesthetically-pleasing flush fit to the wall.



Key Features



INTEGRATED ANDROID



SUPER-FAST LAN/WI-FI



IPS PANEL



24/7 COMMERCIAL USE



LANDSCAPE OR PORTRAIT ORIENTATION



450CD/M² BRIGHTNESS



10 TOUCH POINTS



INTEGRATED SPEAKERS



ATTACH DEVICES



SURFACE PLASMA TREATMENT

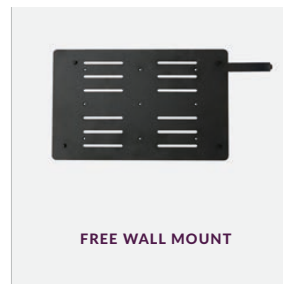

FREE WALL MOUNT



GIANT TABLET STYLING

SUREVIEW

Specification Table

		43 Inch
Panel	Resolution	1920x1080
	Display Area (mm)	941.2x529.4
	Aspect Ratio	16:9
	Brightness (cd/m ²)	450
	Colour	16.7M
	Viewing Angle	178°
	Contrast Ratio	5,000:1
Touch	Touch Technology	Projected Capacitive
	Touch Points	10
	Glass Hardness	7H minimum
Audio	Speaker Type	2W, 4Ω (x2)
AV Inputs	Inputs (when used as monitor)	HDMI, VGA
	Audio Input (when used as monitor)	Audio Socket (3.5mm)
Power	Power Consumption (W)	45
	Input Voltage	AC110~240V (50Hz~60Hz)
Mechanical	Unit Size (WxHxD mm)	997.6x585.8x50.6
	Package Size (WxHxD mm)	1095x690x170
	VESA Holes (mm)	400x200
	Net Weight (kg)	17.05
	Gross Weight (kg)	20.75
Environmental	Operating Temperature	0 °C to 50 °C
	Storage Temperature	-30°C to 60°C
	Operating Humidity	10% to 80%
	Storage Humidity	5% to 95%
Computer	Media Formats	Video (MPG, AVI, MP4, RM, RMVB, TS), Audio (MP3, WMA), Image (JPG, GIF, BMP, PNG)
	Media Resolution	1920x1080/1080x1920
	CPU	Quad-Core ARM Cortex A17, 1.6GHz
	GPU	Quad-Core ARM Mali-T764
	RAM	DDR3 2GB
	Internal Storage	8GB eMMC
	USB	1 x USB (OTG/HOST), 1 x USB (HOST)
	LAN	100M/1000M Ethernet
	Wi-Fi	802.11b/g/n/ac
	OS	Android 7.1
Accessories	Included	Remote Control, User Manual, Power Cable, USB to USB Cable, Wi-Fi Aerial, Wall Mount
	Optional	Floor Stand/Trolley, Ceiling Mount, Table Stand
Warranty	Warranty Period	3 Year Warranty
	Technical Support	Lifetime

Errors and omissions excepted



SUREVIEW

Technical Drawing

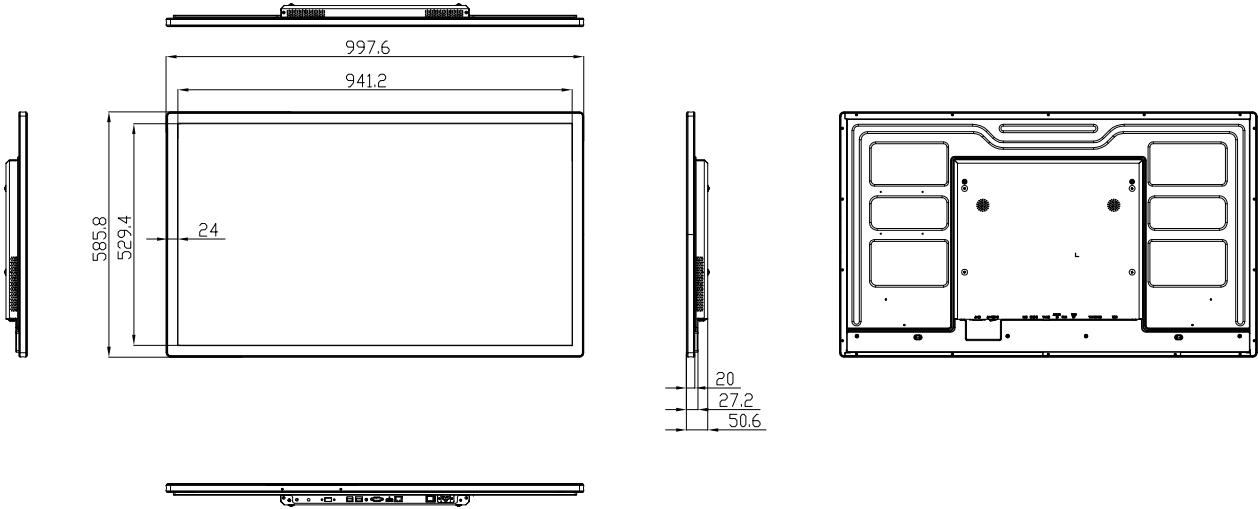

Why Choose Our Commercial Display Solutions?



Lifetime Technical Support

From the moment you receive your product, throughout the duration of your warranty and even after your warranty has expired we are here to support you. If you require any assistance setting up or using your product, or have any problems at all, we can provide free technical support via telephone and email.



On-site Support and Maintenance*

If needed, we can provide an installation service for any of our products. We can also set up service-level agreements for larger projects that require maintenance contracts.



Extended Warranty*

All of our commercial display products come with a 3 year commercial warranty as standard but if you want to extend this you can upgrade this to cover a 5 year period at point of purchase.



Training

As well as providing free remote CMS training sessions and webinars we can also visit you to deliver bespoke training for our software and hardware*.



Advanced Replacements†

Should your display suffer from any kind of hardware failure during the warranty period we will send you an advanced replacement and arrange for your old display to be collected, free of charge. This ensures no downtime where you are without a screen.



Custom Product Testing & Configuration

If you need us to test third party software or a website, or configure your screen in a particular way before it is dispatched (e.g. in a particular orientation or network mode), we can do so to make your life easier.



3D Rendering

Want to know how a particular screen will look once installed? Send us a photo of the location and we will create a 3D rendering of any screen in situ to help you to visualise how amazing it will look.



Logistics Support

We hold more stock in our UK warehouse than any other manufacturer so we can help you meet tight deadlines. For last minute orders we can also offer special express or morning delivery options*. We also carry out UK based quality control checks on every display before it leaves our warehouse.



Project Support

If you need to loan a sample unit to test we'd be more than happy to arrange this. We can also provide a rental service for temporary projects*.



Customisation*

Your display can be customised to suit your requirements by adding your logo or printed graphics or even tailoring the colour of a display. We can also carry out hardware modifications to existing products or manufacture bespoke solutions for special projects.



Extras*

As well as being able to provide accessories and add-ons, such as extra remote controls, NUC PCs and video wall controllers, we can also supply custom made flight cases which are great if a display needs to be moved safely from place to place.

Assured Systems

Assured Systems is a leading technology company with over 1,500 regular clients in 80 countries, deploying over 85,000 systems to a diverse customer base in 12 years of business. We offer high-quality and innovative rugged computing, display, networking and data collection solutions to the embedded, industrial, and digital-out-of-home market sectors.

US

sales@assured-systems.com

Sales: +1 347 719 4508
Support: +1 347 719 4508

1309 Coffeen Ave
Ste 1200
Sheridan
WY 82801
USA

EMEA

sales@assured-systems.com

Sales: +44 (0)1785 879 050
Support: +44 (0)1785 879 050

Unit A5 Douglas Park
Stone Business Park
Stone
ST15 0YJ
United Kingdom

VAT Number: 120 9546 28
Business Registration Number: 07699660