

DX-1200

12th Gen. Intel® Core™ Series High Performance and Compact Rugged Embedded Computer

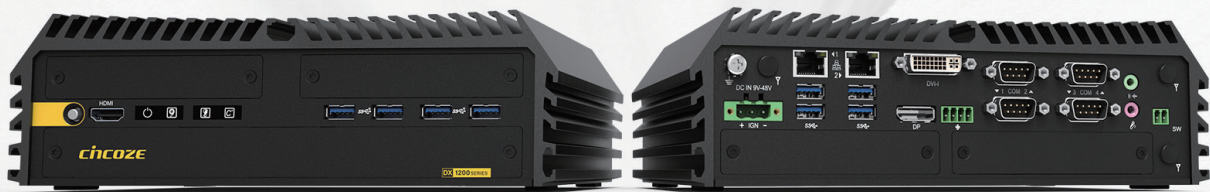

MAX. PERFORMANCE | MIN. FOOTPRINT

DX-1200, 12th Gen. Intel Alder Lake-S Rugged Embedded Computer

Overview

The DX-1200 is a fanless embedded computer that packs extreme performance into a rugged, compact chassis, making it the ideal choice for smart manufacturing, machine vision, and edge AI applications. A 12th gen Intel® Core™ (Alder Lake-S) processor (TDP up to 65W) and DDR5 4800 MHz memory provide high-speed computing performance, while additional functions, including rich native I/O and modular expansion design, meet the requirements for a wide range of applications.

- Intel® 12th Gen Alder Lake-S Core™ i9/i7/i5/i3 Processors (max 65 W TDP)
- 2 x DDR5 SO-DIMM Sockets, Supports ECC/non ECC type Memory, Up to 4800MHZ, 64GB
- Quad Independent Display (HDMI / DP / DVI-I)
- 1x M.2 Key E Type 2230 Socket for Intel CNVi / Wireless Module
- CMI Technology for Optional I/O Module Expansions
- CFM Technology for Power Ignition Sensing & PoE Function
- Wide Operating Temperature -40°C to 70°C
- Safety Standard: UL, c-UL, CB, IEC, EN 62368-1



Rapid Processing and Inference

The DX-1200 supports 12th gen Intel® Core™ i9/i7/i5/i3 (Alder Lake-S) processors based on the Intel 7 process, with up to 16 cores (8P + 8E) and 24 threads, delivering more than 1.35x the speed of Comet Lake-S platform. The Intel® Xe architecture of the UHD 770 graphics chip boosts GPU image classification inference performance to 2.8x the speed of Comet Lake-S, providing the processing performance needed for AI and edge computing.

CPU Performance



GPU Image Classification Inference Performance

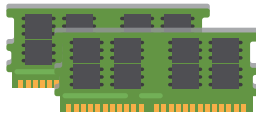

DDR5 ECC Memory

High-speed, Safe Memory

Two DDR5 SO-DIMM slots support up to 64GB of 4800MHz memory and include ECC (Error Correction Code) technology, giving the extra stability and reliability needed for industrial automation applications.

Rich and Diverse Expandability

To cater to the widest range of industrial applications, the DX-1200 provides one M.2 Key E slot and two Mini PCIe slots for the addition of WiFi, GNSS, 4G, and Bluetooth. The Mini PCIe slots also support I/O expansion cards, frame grabber cards, and more, to meet different application requirements.



High-speed, Reliable Data Transmission

To improve the transfer rate of videos or large files, the DX-1200 supports up to four high-speed 10Gbps LAN ports. And for application environments that require multiple network connections, the DX-1200 supports up to 8x PoE, providing data and power through the same cable to reduce the difficulty of wiring.

Robust and Reliable

The DX-1200 is built tough, reflected in its industrial-grade protection design and industry certifications in different fields. In addition to features such as wide temperature (-40 - 70°C), wide voltage input (9 - 48 VDC), overvoltage, overcurrent, and ESD protection, it also complies with the US military shock vibration standard MIL-STD-810G. Product safety and reliability are further ensured with internationally recognized UL 62368-1 safety certification. For more secure railway computing, it also passes the EMC EN 50121-3-2 standard in EN 50155 and the EN 45545-2 fire protection standard.



Specifications

Model Name	DX-1200
System	
Processor	<ul style="list-style-type: none"> • 12th Generation Intel® Alder Lake-S Series CPU: <ul style="list-style-type: none"> - Intel® Core™ i9-12900E 16 Cores Up to 5 GHz, TDP 65W - Intel® Core™ i7-12700E 12 Cores Up to 4.8 GHz, TDP 65W - Intel® Core™ i5-12500E 6 Cores Up to 4.5 GHz, TDP 65W - Intel® Core™ i3-12100E 4 Cores Up to 4.2 GHz, TDP 60W - Intel® Core™ i9-12900TE 16 Cores Up to 4.8 GHz, TDP 35W - Intel® Core™ i7-12700TE 12 Cores Up to 4.7 GHz, TDP 35W - Intel® Core™ i5-12500TE 6 Cores Up to 4.3 GHz, TDP 35W - Intel® Core™ i3-12100TE 4 Cores Up to 4.0 GHz, TDP 35W - Intel® Pentium® G7400E 2 Cores Up to 3.6 GHz, TDP 46W - Intel® Pentium® G7400TE 2 Cores Up to 3.0 GHz, TDP 35W - Intel® Celeron® G6900E 2 Cores Up to 3.0 GHz, TDP 46W - Intel® Celeron® G6900TE 2 Cores Up to 2.4 GHz, TDP 35W
Chipset	• Intel R680E Chipset
Memory	• 2x DDR5 4800 MHz SO-DIMM Socket, Supports Un-buffered and ECC Type, Up to 64GB
BIOS	• AMI BIOS
Graphics	
Graphics Engine	<ul style="list-style-type: none"> • Integrated Intel® UHD Graphics 770: Core™ i9/i7/i5 • Integrated Intel® UHD Graphics 730: Core™ i3 • Integrated Intel® UHD Graphics 710: Pentium®/Celeron®
Maximum Display Output	• Supports Quad Independent Display
DVI	<ul style="list-style-type: none"> • 1x DVI-I Connector - VGA: 1920 x 1080 @ 60 Hz - DVI-D: 1920 x 1200 @ 60 Hz
DP	<ul style="list-style-type: none"> • 1x DP Connector: 4096 x 2304 @ 60Hz * Verified maximum resolution: 3840 x 2160 @ 60Hz
HDMI	• 1x HDMI Connector: 3840 x 2160 @ 30Hz
Audio	
Audio Codec	• Realtek® ALC888, High Definition Audio
Line-out	• 1x Line-out, Phone Jack 3.5mm
Mic-in	• 1x Mic-in, Phone Jack 3.5mm
I/O	
LAN	<ul style="list-style-type: none"> • 2x 1GbE LAN, RJ45(Supports Wake on LAN, PXE) - GbE1: Intel® I219 - GbE2: Intel® I210
COM	• 4x RS-232/422/485 with Auto Flow Control (Supports 5V/12V), DB9
USB	<ul style="list-style-type: none"> • 4x 10Gbps USB 3.2 Gen2, Type A • 4x 5Gbps USB 3.2 Gen1, Type A
Storage	
SSD/HDD	• 2x 2.5" SATA HDD/SSD Bay (SATA 3.0)
mSATA	• 2x mSATA Socket (SATA 3.0, shared by Mini-PCIe socket)
RAID	• Support RAID 0/1/5/10

Expansion	
Mini PCI Express	• 2x Full-size Mini-PCIe Socket
M.2 E Key Socket	• 1x M.2 Key E Type 2230 Socket, Support Intel CNVi Module
SIM Socket	• 1x SIM Socket
CMI (Combined Multiple I/O) Interface	• 2x High Speed CMI Interface for optional CMI Module Expansion • 1x Low Speed CMI Interface for optional CMI Module Expansion
CFM (Control Function Module) Interface	• 1x CFM IGN Interface for optional CFM-IGN Module Expansion
Other Function	
External FAN Connector	• 1x External FAN Connector, 4-pin Terminal Block (Support Smart Fan by BIOS)
Clear CMOS Switch	• 1x Clear CMOS Switch
Reset Button	• 1x Reset Button
Instant Reboot	• Support 0.2sec Instant Reboot Technology
Watchdog Timer	• Software Programmable Supports 256 Levels System Reset
Power	
Power Button	• 1x ATX Power On/Off Button
Power Mode Switch	• 1x AT/ATX Mode Switch
Power Input	• 9-48VDC, 3-pin Terminal Block
Remote Power On/Off	• 1x Remote Power On/Off, 2-pin Terminal Block
Physical	
Dimension (W x D x H)	• 242 x 173 x 75 mm
Weight Information	• 3.05 kg
Mechanical Construction	• Extruded Aluminum with Heavy Duty Metal
Mounting	• Wall / DIN-RAIL / VESA / Side Mount
Physical Design	• Fanless Design • Cableless Design • Jumper-less Design • Unibody Design
Reliability & Protection	
Reverse Power Input Protection	• Yes
Over Voltage Protection	• Protection Range: 51~58V • Protection Type: shut down operating voltage, re-power on at the preset level to recover
Over Current Protection	• 15A
CMOS Battery Backup	• SuperCap Integrated for CMOS Battery Maintenance-free Operation
MTBF	• 394,488 Hours - Database: Telcordia SR-332 Issue3, Method 1, Case 3
Operating System	
Windows	• Windows® 10
Linux	• Supports by project

Environment	
Operating Temperature	<ul style="list-style-type: none"> • 35W TDP Processor: -40°C to 70°C • 65W TDP Processor: -40°C to 50°C (With External Fan Kit) <ul style="list-style-type: none"> - With extended temperature peripherals; Ambient with air flow - According to IEC60068-2-1, IEC60068-2-2, IEC60068-2-14
Storage Temperature	<ul style="list-style-type: none"> • -40°C to 85°C
Relative Humidity	<ul style="list-style-type: none"> • 95% RH @ 70°C (Non-condensing)
Shock	<ul style="list-style-type: none"> • MIL-STD-810G (Pending)
Vibration	<ul style="list-style-type: none"> • MIL-STD-810G (Pending)
EMC	<ul style="list-style-type: none"> • CE, UKCA, FCC, ICES-003 Class A • EN 50155 (EN 50121-3-2 Only) • E-Mark
Safety	<ul style="list-style-type: none"> • UL, cUL, CB, IEC/EN 62368-1 (Pending)
Fire Protection	<ul style="list-style-type: none"> • EN 45545-2

External Layout

Front I/O

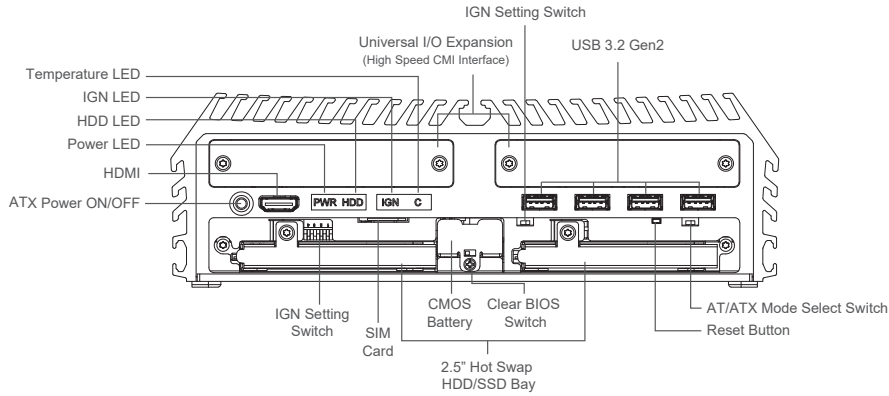

Rear I/O

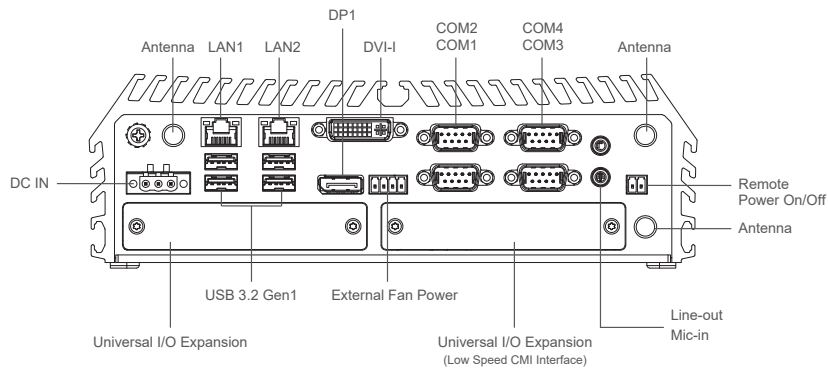

Dimensions

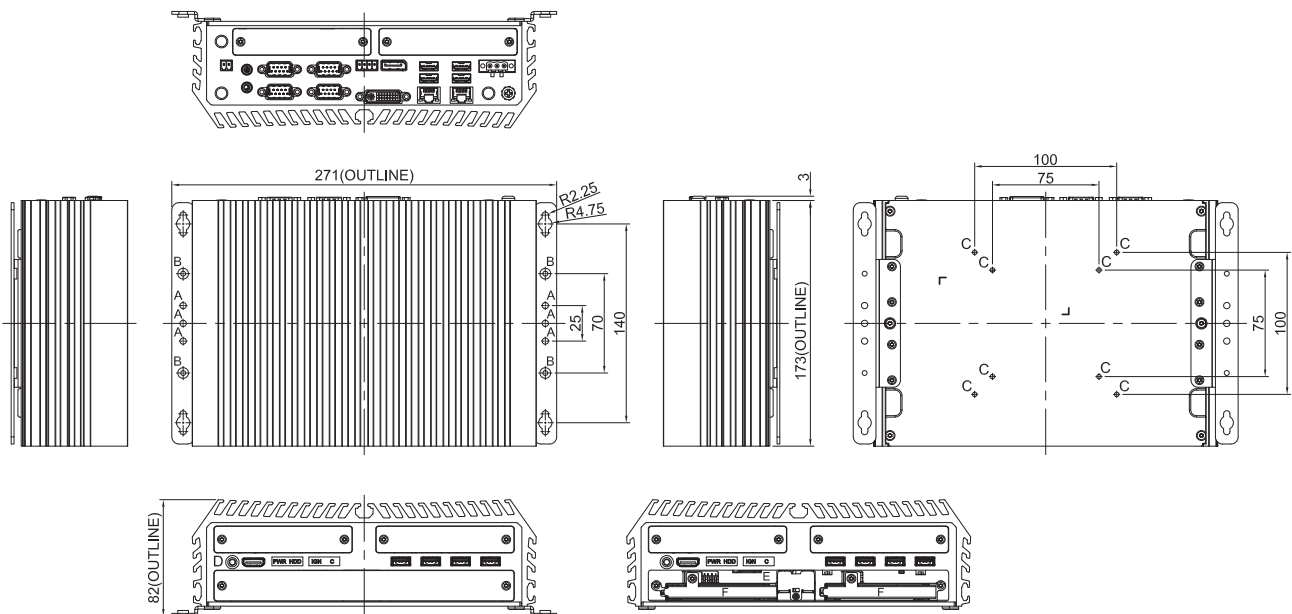

Unit: mm

Ordering Information

Available Models

Model No.	Description
DX-1200-R10	12th Gen. Intel® Core™ Series High Performance and Compact Rugged Embedded Computer

Package Checklist







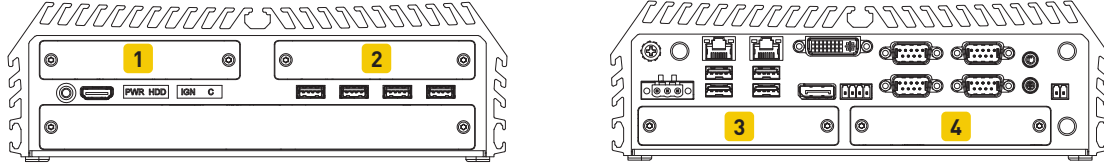

• DX-1200 Rugged Computer x1	• Power Terminal Block Connector x1
• CPU Heatsink Pack x1	• Remote Power On/Off Terminal Block Connector x 1
• Screw Pack x 1	• Fan Terminal Block Connector x 1
• Wall Mounting Kit x1	• DVI-I to VGA Adaptor x 1

Optional Modules and Accessories

Model No.	Description
CFM-PoE01	CFM Module with PoE Control Function, Individual Port 25.5W
CFM-IGN01	CFM Module with Power Ignition Sensing Control Function, 12V/24V Selectable
CMI-LAN01-R12	CMI Module with 4x RJ45 Intel I210 1GbE LAN Ports
CMI-10GLAN05-R10	CMI Module with 2x Intel 10GbE LAN, RJ45 Port
CMI-M12LAN01-R12	CMI Module with 4 x M12 Intel I210 1GbE LAN Ports
CMI-XM12LAN01-R10	CMI Module with M12 X-Coded Connector, 4x Intel I210 1GbE LAN Ports
CMI-DIO01	CMI Module with 16DIO (8in 8out)
CMI-COM01	CMI Module with 2x RS232/422/485 (Support 5V/12V)
MEC-COM-M212-TDB9	Mini-PCIe Module with 2x RS-232 Serial Ports, 1x Thin DB9 Cable
MEC-COM-M334-TDB9	Mini-PCIe Module with 4x RS-232/422/485 Serial Ports, 2x Thin DB9 Cable
MEC-LAN-M102-30	Mini-PCIe Module with 2x LAN Ports, 2x 30cm cable
UB0930-R10	Universal Bracket with 4x M12 X-Coded Cutout
UB1303	Universal Bracket with 2x DB9 Cutout
UB1311	Universal Bracket with 2x RJ45 Cutout for MEC-LAN Expansion
UB1318	Universal Bracket with DIO Cutout
UB1710-R10	Universal Bracket with 4x M12 A-Coded Cutout
UB1712-R10	Universal Bracket with 4x RJ45 Cutout
UB1728-R10	Universal Bracket with 2x RJ45 Cutout for CMI-10GLAN Expansion
SIDE-DX	DX Series side mount kit
DIN01	DIN-RAIL Mount Kit, KMRH-K175
GST120A24-CIN	Adapter AC/DC 24V 5A 120W with 3pin Terminal Block Plug and Tubes, Level VI
GST220A24-CIN	Adapter AC/DC 24V 9.2A 220W with 3pin Terminal Block Plug and Tubes, Level VI
FAN-EX101	External Fan with 4pin Terminal Block Plug and Mounting Bracket, Support smart fan

Optional Module Configuration



Model No.	Description	1	2	3	4
CMI-LAN01-R12/UB1712-R10 	CMI Module with 4x Intel I210 1GbE LAN, RJ45 Port / Universal Bracket with 4x RJ45 Cutout	V	V	--	--
CMI-10GLAN05-R10/UB1728-R10 	CMI Module with 2x Intel 10GbE LAN, RJ45 Port/ Universal Bracket with 2x RJ45 Cutout	V	V	--	--
CMI-M12LAN01-R12/UB1710-R10 	CMI Module with M12 Connector, 4x Intel 1GbE LAN / Universal Bracket with 4x M12 A-Coded Cutout	V	V	--	--
CMI-XM12LAN01-R10/UB0930-R10 	CMI Module with M12 X-Coded Connector, 4x Intel I210 1GbE LAN Ports / Universal Bracket with 4x M12 X-Coded Cutout	V	V	--	--
CMI-DIO01/UB1318 	CMI Module with 16DIO (8in 8out) / Universal Bracket with DIO Cutout	--	--	--	V
CMI-COM01/UB1303 	CMI Module with 2x RS232/422/485 (Support 5V/12V) / Universal Bracket with 2x DB9 Cutout	--	--	--	V
MEC-COM-M212-TDB9/UB1303 	Mini-PCIe Module with 2x RS-232 Serial Ports, 1x Thin DB9 Cable / Universal Bracket with 2x DB9 Cutout	--	--	V	V
MEC-COM-M334-TDB9/2xUB1303 	Mini-PCIe Module with 4x RS-232/422/485 Serial Ports, 2x Thin DB9 Cable / 2x Universal Bracket with 2x DB9 Cutout	--	--	V	
MEC-LAN-M102-30/UB1311 	Mini-PCIe Module with 2x LAN Ports, 2x 30cm cable / Universal Bracket with 2x RJ45 Cutout for MEC-LAN Expansion	--	--	V	--

Assured Systems

Assured Systems is a leading technology company with over 1,500 regular clients in 80 countries, deploying over 85,000 systems to a diverse customer base in 12 years of business. We offer high-quality and innovative rugged computing, display, networking and data collection solutions to the embedded, industrial, and digital-out-of-home market sectors.

US

sales@assured-systems.com

Sales: +1 347 719 4508

Support: +1 347 719 4508

1309 Coffeen Ave
Ste 1200
Sheridan
WY 82801
USA

EMEA

sales@assured-systems.com

Sales: +44 (0)1785 879 050

Support: +44 (0)1785 879 050

Unit A5 Douglas Park
Stone Business Park
Stone
ST15 0YJ
United Kingdom

VAT Number: 120 9546 28

Business Registration Number: 07699660