

CS-110/P1000 | 10.4" TFT-LCD Sunlight Readable Touch Panel PC with Intel® Atom™ E3845 Quad Core Processor



- 10.4" TFT-LCD with Ultra High Brightness up to 1,500 nits and 1024 x 768 (XGA) Resolution
- Onboard Intel® Atom™ E3845 Processor Quad Core, 1.91GHz
- Supports 1x DDR3L SO-DIMM Socket, up to 8 GB
- 1x 2.5" SATA Drive Bay, 1x CFast Card and 1x SIM Card Socket
- 2x GbE LAN, 4x USB, 2x COM, 1x VGA, 1x DisplayPort, 4x DI/4x DO
- 1x Mini-PCIe Expansion Socket for Wireless and I/O Expansion
- Wide Range Operating Temperature -20°C to 70°C
- Designed with Aluminum Die-casting Front Frame
- True Flat IP65 Front Panel Protection
- Supports Panel / VESA / Rack Mounting
- Convertible Display System (CDS) Technology Supported



Overview

CS-110/P1000 Series is a 10.4" TFT-LCD sunlight readable touch panel PC offering 1,500 nits ultra high brightness and 1024 x 768 (XGA) resolution. The system is equipped with Intel® Atom® E3845 processor and provides extensive I/O including 2x GbE, 4x USB, 2x RS232/422/485, 4x DI/4x DO, 1x VGA and 1x DisplayPort. It also supports 1x Mini-PCIe slot and 1x SIM socket for a variety of wireless connections, such as BT/WiFi and 3G/LTE. In addition, there are 2 types of storage devices including 2.5" SATA HDD and CFast. The accessible design of these storage devices allows quick data access and easy maintenance.

CS-110/P1000 Series supports Convertible Display System (CDS) technology. Comparing to regular standalone panel PCs, it can lower maintenance cost and reduce unplanned downtime.

Furthermore, CS-110/P1000 Series is a truly rugged display system supporting wide range operating temperature (-20°C to 70°C), IP65 dust/water proof front panel, wide range DC power input (9 to 48VDC) and rigorous industrial protections.

Highlights



Sunlight Readable

Providing ultra high brightness 1,500 nits and resolution up to 1024 x 768 (XGA), CS-110/P1000 Series is suitable for all lighting conditions including direct sunlight.



Wide Temperature

CS-110/P1000 Series supports wide range operating temperature from -20°C to 70°C and is suitable for deploying in extreme and harsh environments.



Multiple Functions

CS-110/P1000 Series provides extensive I/O, Mini-PCIe slot, 2.5" SATA drive bay, CFast socket, and SIM card slot.

Specifications

Display

- LCD Size: 10.4" (4:3)
- Max. Resolution: 1024 x 768
- Brightness (cd/m2): 1500
- Contrast Ratio: 1400 : 1
- LCD Color: 16.2M
- Pixel Pitch (mm): 0.206 (H) x 0.206 (V)
- Viewing Angle (H-V): 178 / 178
- Backlight MTBF: 50000 hrs (LED Backlight)

Touch

- Projected Capacitive Touch

Processor System

- Onboard Intel® Atom™ Processor E3845 Quad Core, 1.91 GHz with AMI 64Mbit SPI BIOS

Memory

- 1x 204-Pin SO-DIMM DDR3L 1066/ 1333MHz (un-buffered and non-ECC), max. up to 8GB

I/O Ports

- 1x VGA
- 1x DisplayPort
- 1x USB 3.0
- 3x USB 2.0
- 2x DB9 for COM1~2, Support RS232/422/485 with Auto Flow Control
- 1x Line-out
- 1x Mic-in
- 1x Power Switch
- 1x Reset Button
- 1x AT/ATX Switch

Digital Input & Output

- 4x Digital Input (Source Type)
 - Input Voltage (Dry Contact):
 - Logic 0: Close to GND
 - Logic 1: Open
 - Input Voltage:
 - Logic 0: -3V(Min/ D1 to COM+)
- 4x Digital Output
 - Supply Voltage: 5~30 VDC
 - Sink Current: 580mA Max
 - DIO Max: 30V

Expansion

- 1x Full-size Mini PCIe Socket for Wi-Fi / GSM / Expansion Module
- 2x Universal I/O Brackets [CS-110HC/P1001E]

Other Features

- Watchdog Timer:
 - Software Programmable Supports 256 Levels System Reset
- Audio: AMP 2W + 2W (Internal Speaker)
- OSD Function: LCD On/Off, Brightness Up/Down

Ethernet

- 2x Intel® i210 GbE LAN Port, Support Wake-on-LAN and PXE

Storage

- 1x External 2.5" SATA Drive Bay
- 1x External CFast Socket
- 1x External SIM Card Socket

Power

- Support AT, ATX Mode
- 1x 3-pin Terminal Block Connector with Power Input 9~48VDC
- 1x Optional AC/DC 12V/5A, 60W Power Adapter

Physical

- Dimensions (WxDxH, mm): CS-110HC/P1001: 295 x 227.3 x 65 mm
CS-110HC/P1001E: 295 x 227.3 x 87.85 mm
- Weight: CS-110HC/P1001: 3.58 kg
CS-110HC/P1001E: 3.78 kg
- Front Panel Construction: Flat Rugged Aluminum Die-casting Bezel
- Mounting: Panel / VESA / *Rack Mounting (*with optional mounting kit)

Environment

- Operating Temperature: Ambient with air flow: -20°C to 70°C (with Industrial Grade Peripherals)
- Storage Temperature: -20°C to 70°C
- Relative Humidity: 80% RH @ 40°C (Non-Condensing)
- Shock: Operating, 15 Grms, Half-sine 11 ms Duration (w/ SSD, according to IEC60068-2-27)
- Vibration: Operating, 1.5 Grms, 5-500 Hz, 3 Axes (w/ SSD, according to IEC60068-2-64)
- IP Level: IP 65 Compliant Front Panel
- EMC: CE, FCC Class A

Protection

- Reverse Power Input Protection
- Over Voltage Protection:
 - Protection Range: 51~58V
 - Protection Type: shut down operating voltage, re-power on at the preset level to recover
- Over Current Protection: 20A
- ESD Protection: +/-8kV (air), +/-4kV (contact)
- Surge Protection: 3kW

Operating System

- Windows® 10
- Windows® 8.1
- Windows® 7

Certification

- CE
- FCC Class A

External Layout

CS-110/P1001

Front

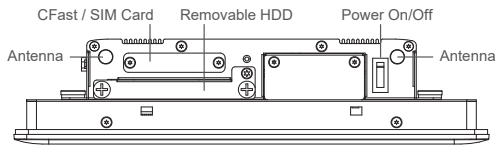

Rear

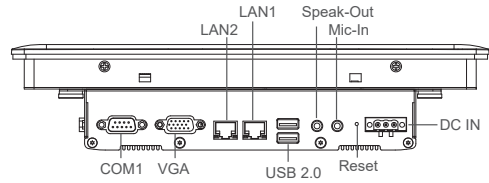

Left

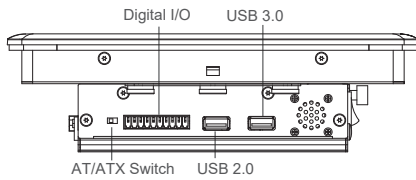

Right

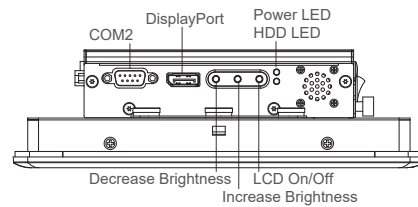

CS-110/P1001E

Front

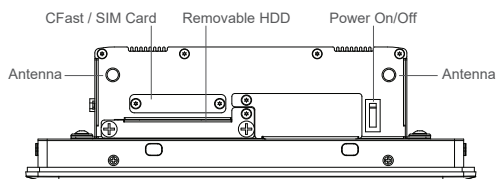

Rear

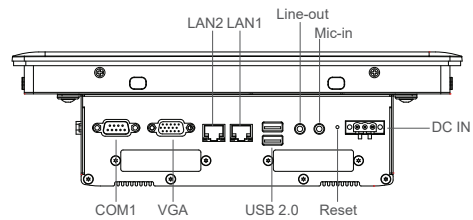

Left

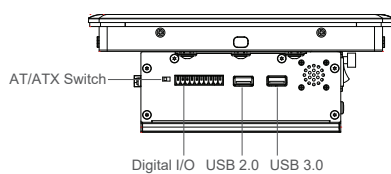

Right

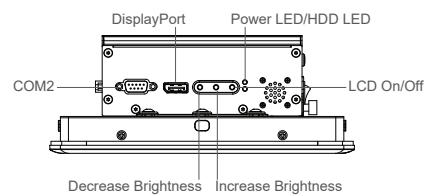

Dimensions

CS-110/P1001

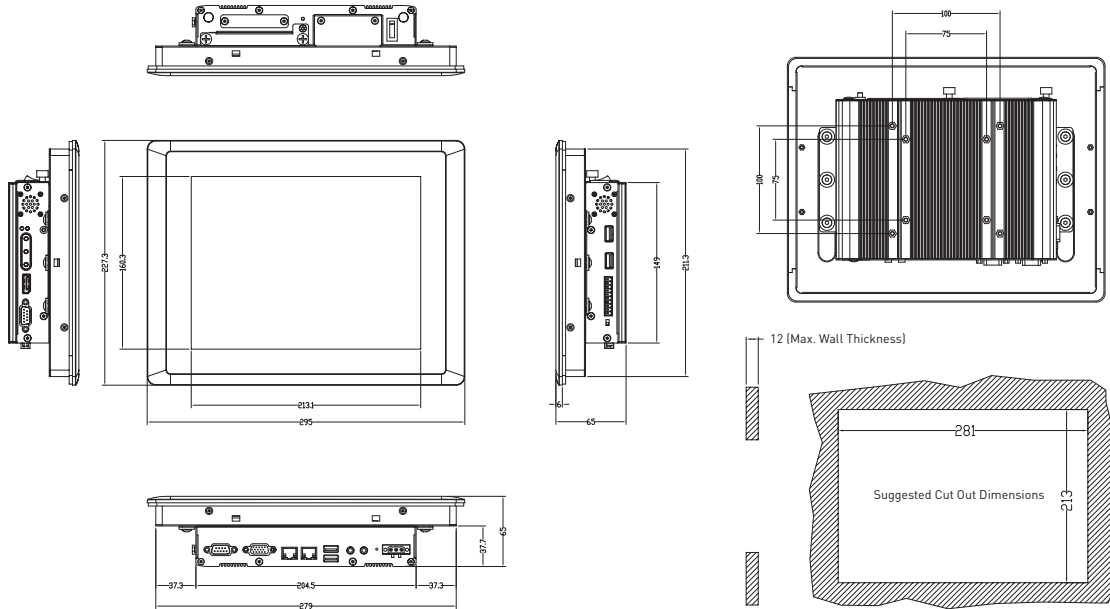

CS-110/P1001E

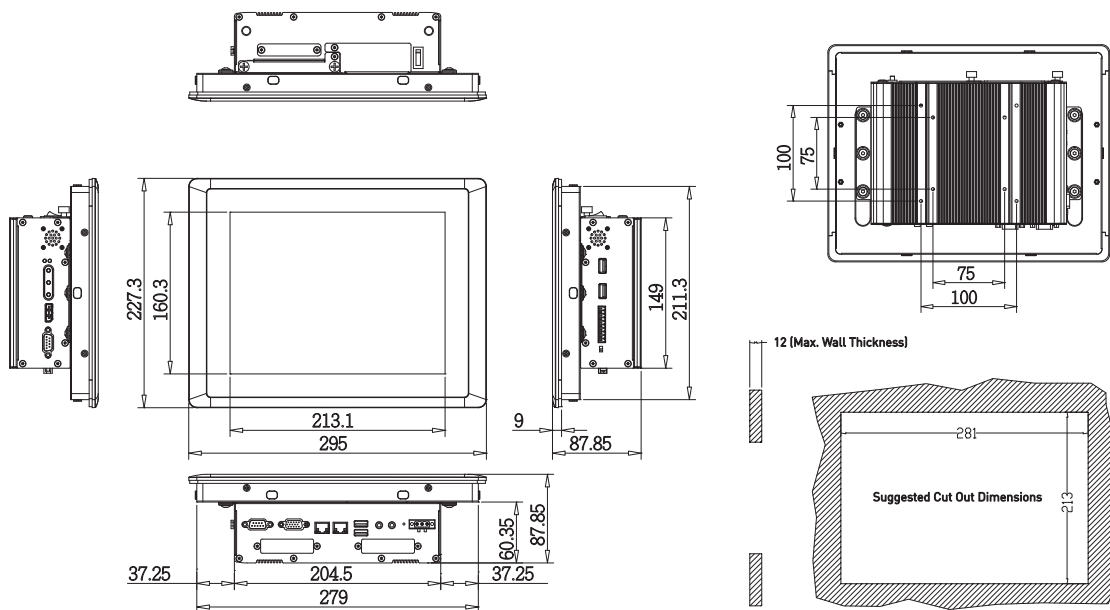

Unit: mm

Ordering Information

Available Models

Model No.	Description
CS-110HC-R10/P1001-R10	10.4" TFT-LCD 1500 nits Sunlight Readable Touch Panel PC with Intel® Atom™ E3845 Quad Core Processor and P-Cap. Touch
CS-110HC-R10/P1001E-R10	10.4" TFT-LCD 1500 nits Sunlight Readable Touch Panel PC with Intel® Atom™ E3845 Quad Core Processor, P-Cap. Touch and 2x Universal I/O Bracket

Package Checklist

- Panel PC x 1
- Panel Mounting Kit x 1
- Utility DVD Driver x 1
- DIO Terminal Block Connector x 1
- Power Terminal Block Connector x 1
- HDD Screw Pack x 1
- Mini PCIe Screw Pack x 1

Optional Modules & Accessories

Model No.	Description
GST60A12-CIN1	Adapter AC/DC 12V 5A 60W, GST60A12-CIN1, wide temp(-30°C ~ +70°C)
SL2-SL3	US 2 heads power cord, US B type to IEC C13, SVT 18AWG/3C Black 1.8M SL-2+SL-3
SL6-SL3	EU 2 heads power cord, EU G type to IEC C13, H05VV-F 0.75mm2/3G Black 1.8M SL-6+SL-3
QP026-SL3	UK 2 heads power cord, UK I type to IEC C13, H05VV-F 0.75mm2/3G Black 1.8M QP026+SL-3
URM01	Universal 19" Rack Mount Kit for Industrial Panel PC & Industrial Monitor
MEC-COM-M212/UB0303	Mini-PCIe Module with 2x COM Ports, 2x Universal Brackets (65 x 16 mm)
MEC-LAN-M002-R1/UB0311	Mini-PCIe Module with 2x LAN Ports, 1x Universal Bracket (65 x 16 mm)
MEC-USB-M002/UB0314	Mini-PCIe Module with 2x USB 3.0 Ports, 1x Universal Bracket (65 x 16 mm)

Assured Systems

Assured Systems is a leading technology company with over 1,500 regular clients in 80 countries, deploying over 85,000 systems to a diverse customer base in 12 years of business. We offer high-quality and innovative rugged computing, display, networking and data collection solutions to the embedded, industrial, and digital-out-of-home market sectors.

US

sales@assured-systems.com

Sales: +1 347 719 4508
Support: +1 347 719 4508

1309 Coffeen Ave
Ste 1200
Sheridan
WY 82801
USA

EMEA

sales@assured-systems.com

Sales: +44 (0)1785 879 050
Support: +44 (0)1785 879 050

Unit A5 Douglas Park
Stone Business Park
Stone
ST15 0YJ
United Kingdom

VAT Number: 120 9546 28
Business Registration Number: 07699660